















**Zolarex**  
INTERNATIONAL

[www.zolarexinel.com](http://www.zolarexinel.com)

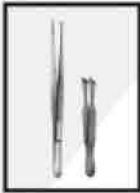
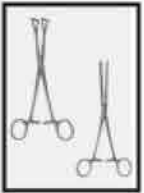
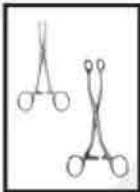
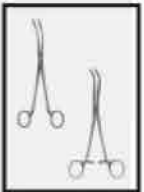

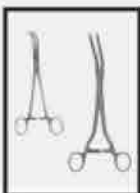





**SURGICAL  
INSTRUMENTS**



# Table Of Contents

	Page Seite			Seite	
Diagnostic, Anaesthesia and other instruments	1 - 10		Probes, Pocket Instruments sets	66 - 68	
Scalpels, knives and Scalpel Handles	11 - 14		Wound Retractors	69 - 80	
Scissors	15 - 31		Self-Retaining Retractors, Abdominal Retractors	81 - 85	
Dissecting-and Tissue Forceps	32 - 42		Abdominal Surgery Intestinal-and Rectal Instruments	86 - 93	
Sponge, Dressing and Tissue Grasping Forceps Towel Clamps	43 - 48		Gall Bladder-, Liver-and Spleen Instruments	94 - 96	
Vessel Clips, Bulldog Clamps Haemostatic Forceps	49 - 57		Genito-Urinary Instruments and Trocars	97 - 100	
Ligature, Hysterectomy and Compression Forceps Vaginal Clamps	58 - 60		Vaginal Specula and Uterine Dilators	101 - 106	
Needle Holders, Suture Instruments	61 - 65		Uterine Probes, Uterine Dressing-, Polypus-and Ovum Forceps	107 - 109	

# Table Of Contents

	Page Seite		Seite	
Biopsy Instruments and Curettes	110 - 116		Suction Instruments	158 - 166 
Obstetrics and Tracheotomy	117 - 119			
Cardiovascular-and Thoracic Surgery	120 - 128			
Bone Punches, Rongeurs	129 - 134			
Elevators, Bone Levers, Raspatories, Bone Files, Bone Curettes	135 - 139			
Mallets, Chisels and Gouges	140 - 141			
Bone Holding Forceps, Bone Rongeurs, Bone Cutting Forceps	142 - 146			
Plaster Instruments	147 - 157			

## Percussion Hammers and Aesthesiometers

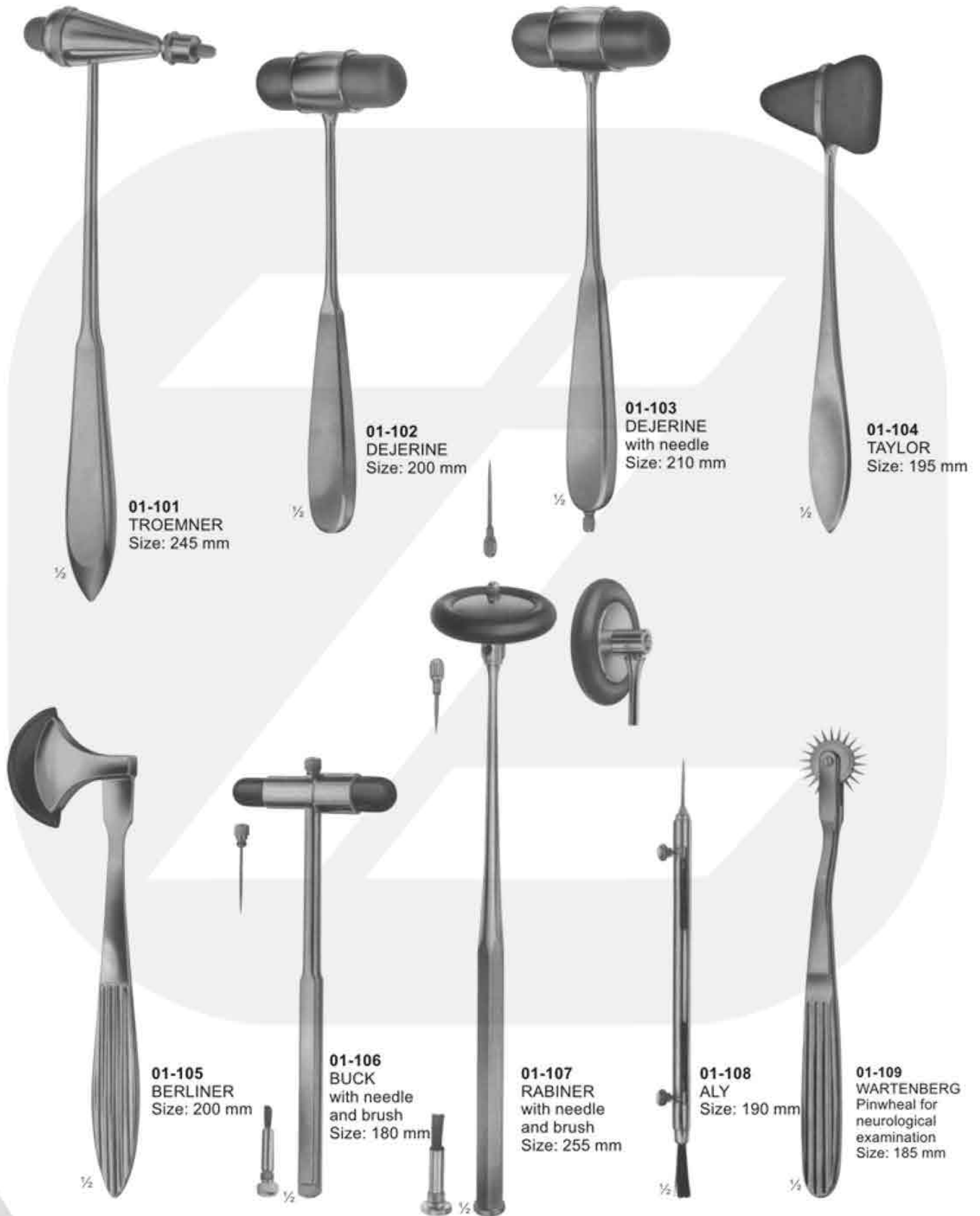



# Stethoscopes



**01-110**  
PINARD (Aluminum)  
Size: 155 mm

1/2



**01-111**  
wooden  
Size: 145 mm

1/2



**01-112**  
BOWLES  
Stethoscope  
with diaphragm

1/4



**01-113**  
ANESTOPHON

1/2



**01-114**  
FORD-BOWLES  
Dual chest piece  
with two outlets

1/4



**01-115**  
BOWLES

1/4

## Head Mirrors and Head Bands



**01-116**  
ZIEGLER  $\varnothing$  90mm  
head mirror only  
with rubber coating



**01-117**  
ZIEGLER  $\varnothing$  90mm  
head mirror only  
with metal coating



**01-118**  
ZIEGLER  
head band of plastic black

**01-119**  
ZIEGLER  
head band of plastic white



**01-120**  
MURPHY  
head band of celluloid, white



**01-121**  
head band of plastic,  
white, soft pattern



**01-122**  
head mirror with black  
plastic head band.

## Tongue Depressors



# Instruments for Anaesthesia and Tongue Forceps



1/2  
**01-134**  
**SCHIMMELBUSCH**  
Ether mask



1/2  
**01-135**  
**HEISTER**  
Mouth gag  
Size: 130 mm



1/2  
**01-136**  
**FERGUSSON-ACKLAND**  
Mouth gag  
Size: 145 mm



1/2  
**01-137**  
**DENHARDT**  
Mouth gag with silicon  
inserts, interchangeable  
Size: 125 mm



1/2  
**01-138**  
**ROSER KOENIG**  
Mouth gag  
Size: 160 mm, 185 mm

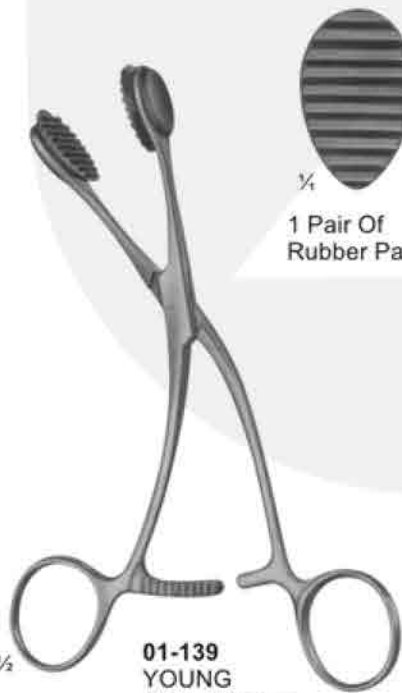

1/2  
**01-139**  
**YOUNG**  
Size: 165 mm



1/4  
1 Pair Of  
Rubber Pads

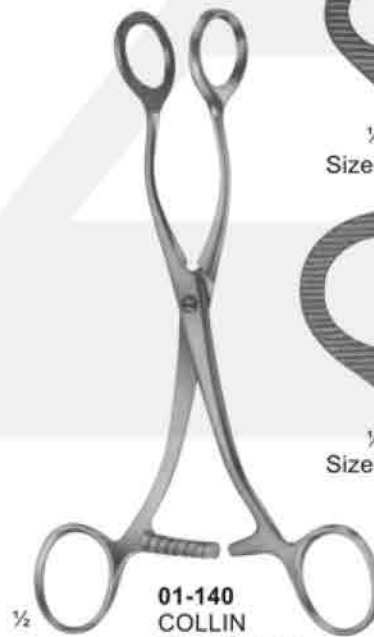

1/2  
**01-140**  
**COLLIN**  
Size: 160 mm,  
170 mm



1/4  
Size: 160 mm



1/4  
Size: 170 mm



1/2  
**01-141**  
**HEYWOOD-SMITH**  
modif. Size: 215 mm



# Blood Lancets and Laryngeal Mirrors

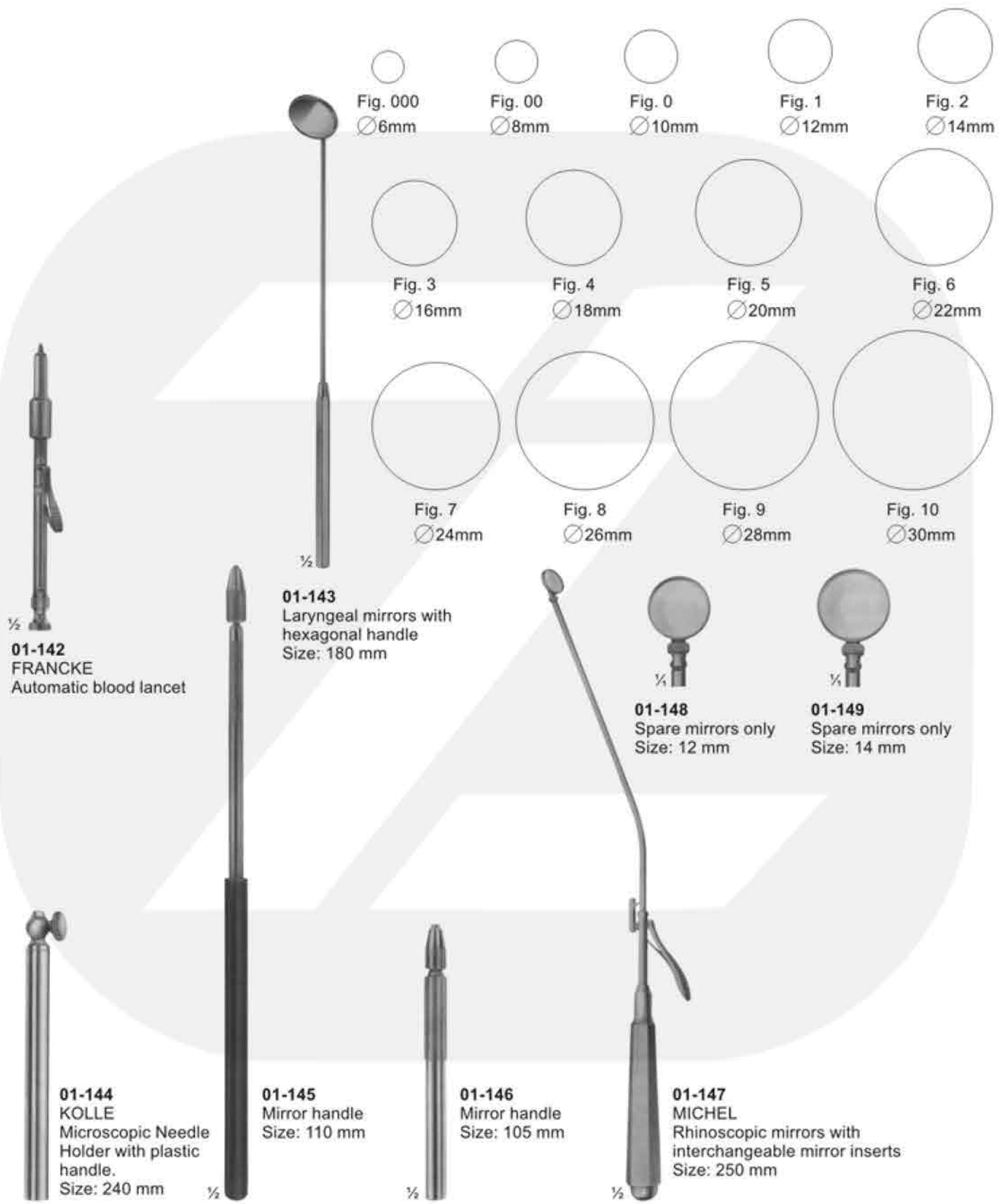

**Fig. 000**  
∅6mm

**Fig. 00**  
∅8mm

**Fig. 0**  
∅10mm

**Fig. 1**  
∅12mm

**Fig. 2**  
∅14mm

**Fig. 3**  
∅16mm

**Fig. 4**  
∅18mm

**Fig. 5**  
∅20mm

**Fig. 6**  
∅22mm

**Fig. 7**  
∅24mm

**Fig. 8**  
∅26mm

**Fig. 9**  
∅28mm

**Fig. 10**  
∅30mm

**01-142**  
FRANCKE  
Automatic blood lancet

**01-143**  
Laryngeal mirrors with hexagonal handle  
Size: 180 mm

**01-148**  
Spare mirrors only  
Size: 12 mm

**01-149**  
Spare mirrors only  
Size: 14 mm

**01-144**  
KOLLE  
Microscopic Needle Holder with plastic handle.  
Size: 240 mm

**01-145**  
Mirror handle  
Size: 110 mm

**01-146**  
Mirror handle  
Size: 105 mm

**01-147**  
MICHEL  
Rhinoscopic mirrors with interchangeable mirror inserts  
Size: 250 mm

## Laryngoscope and Diagnostic Sets



**01-150**  
Infants  
Size: 150 mm

**01-151**  
Children  
Size: 200 mm

**01-152**  
Adults  
Size: 250 mm



**01-154**

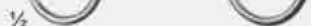

**01-150 - 152**  
MAGILL



**01-153**  
Medium battery handle  
only, 25 mm diam.



**01-153-A**  
Spare bulb  
2.7 volt, for  
otoscopes



**01-153-B**  
Spare bulb  
2.6 volt, for  
ophthalmoscopes



**01-155**



**01-156**  
Otoscope set, consists of  
battery handle without batteries,  
3 ear specula, 1 bulb in valvet lined case



**01-157**  
Diagnostic set, otoscope with three specula,  
nasal speculam, lamp holder, two laryngeal  
mirrors, tongue blade holder

# Laryngoscopes



1/2

**01-158  
MILLER**  
Laryngoscope set, consists of battery handle ( without battery )  
with four miller laryngoscope blades



Fig. 0



Fig. 1



Fig. 2



Fig. 3



Fig. 4

Fig. 0 Working Length, 55 mm (Baby's) 1/2  
Fig. 1 Working Length, 80 mm (Children's)  
Fig. 2 Working Length, 130 mm (Adolescent's)  
Fig. 3 Working Length, 170 mm (Women's)  
Fig. 4 Working Length, 180 mm (Men's)



1/2

**01-159  
GUEDEL-NEGUS**  
Laryngoscope set, consists of battery handle ( without battery )  
with four miller laryngoscope blades



Fig. 1



Fig. 2



Fig. 3



Fig. 4

Fig. 1 Working Length, 70 mm (Children's) 1/2  
Fig. 2 Working Length, 90 mm (Adolescent's)  
Fig. 3 Working Length, 110 mm (Women's)  
Fig. 4 Working Length, 135 mm (Men's)

# Laryngoscopes



**01-160**  
McINTOSH  
Laryngoscope Set, Consists Of Battery Handle ( Without Battery )  
With Three McIntosh Blades, Fig. 1, Fig. 2, Fig. 3



Fig. 0



Fig. 1



Fig. 2



Fig. 3



Fig. 4

**01-161**  
McINTOSH  
Laryngoscope Set, Consists Of Battery Handle ( Without Battery )  
With Five McIntosh Blades, Fig. 0, Fig. 1, Fig. 2, Fig. 3, Fig. 4

01-161 A Fig. 0 Working Length, 55 mm (Baby's)  
01-161 B Fig. 1 Working Length, 75 mm (Children's)  
01-161 C Fig. 2 Working Length, 90 mm (Adolescent's)  
01-161 D Fig. 3 Working Length, 110 mm (Women's)  
01-161 E Fig. 4 Working Length, 135 mm (Men's)



**01-162**  
FOREGGER  
Laryngoscope Set, Consists Of Battery Handle ( Without Battery )  
With Three Foregger Blades,  
Fig. 1, Fig. 2, Fig. 3.



Fig. 1



Fig. 2



Fig. 3



Fig. 4

**01-163**  
FOREGGER  
Laryngoscope Set, Consists Of Battery Handle ( Without Battery )  
With Four Foregger Blades,  
Fig. 1, Fig. 2, Fig. 3, Fig. 4.

01-162 A Fig. 1 Working Length, 70 mm (Children's)  
01-162 B Fig. 2 Working Length, 90 mm (Adolescent's)  
01-162 C Fig. 3 Working Length, 110 mm (Women's)  
01-162 D Fig. 4 Working Length, 135 mm (Men's)



**01-164**  
Fiber Optic  
Battery Handle  
30mm diam.



**01-165**  
Fiber Optic  
Battery Handle  
18mm diam.



**01-166**  
Replacement Lamp  
( Krypton ) 2.5 V



**01-167**  
Replacement Lamp  
( Halogen ) 2.5 V



## Examination & Measuring Instruments



**01-168**  
Caliper Of Aluminium  
Graduated in mm & inches  
up to 180mm  
Measuring Range up to 139mm.



**01-169**  
VERNIER  
Universal Caliper Of Steel  
Graduated in mm & inches  
up to 180mm  
Measuring Range up to 120mm  
with Vernier in 1/10mm & 1/16"



**01-170**  
CARROLL  
Size: 145 mm  
Finger Goniometer



**01-171**  
TOWNLEY  
Graduated in  
mm & inches  
Size: 115 mm



**01-172**  
COLLIN  
Druck Pressure 72 kg  
Size: 125 mm



**01-173**  
BERTILLON  
Caliper For Measuring The Head  
Size: 320 mm



**01-174**  
CASTROVIEJO  
Caliper  
Size: 75mm



**01-175**  
MOLTGEN  
Goniometer



**01-176**  
Size: 150 mm



**01-177**  
Size: 500 mm



# Dissecting Knives



**02-101 - 110**  
Fig. 1 - 10



**02-101**  
Fig. 1  
30 mm



**02-102**  
Fig. 2  
36 mm



**02-103**  
Fig. 3  
40 mm



**02-104**  
Fig. 4  
45 mm



**02-105**  
Fig. 5  
50 mm



**02-106**  
Fig. 6  
27 mm



**02-107**  
Fig. 7  
35 mm



**02-108**  
Fig. 8  
40 mm



**02-109**  
Fig. 9  
47 mm



**02-110**  
Fig. 10  
50 mm

# Amputating Knives, Cartilage Knives and Autopsy Knives



**LISTON**  
**02-111**  
 Size: 130 mm  
**02-112**  
 Size: 160 mm  
**02-113**  
 Size: 190 mm  
**02-114**  
 Size: 200 mm

**02-115**  
**CATLIN**  
 Size: 160 mm  
 Blade length  
 Amputating  
 Knives

**02-116**  
**LANGENBECK**  
 Size: 120 mm  
 Blade length  
 Flap Knives

**02-117**  
 Size: 110 mm  
 Blade length  
 Interosseous  
 Knives

**02-118**  
 Size: 55 mm  
 Blade length  
 with raspatory,  
 Wooden handle

**02-119**  
 Size: 70 mm  
 Blade length  
 Wooden handle

**02-120**  
 Size: 80 mm  
 Blade length  
 Metal handle

**02-121**  
 Size: 195 mm  
 Blade length  
 Metal handle

Blade length  
 Amputating Knives





## Scalpel Handles

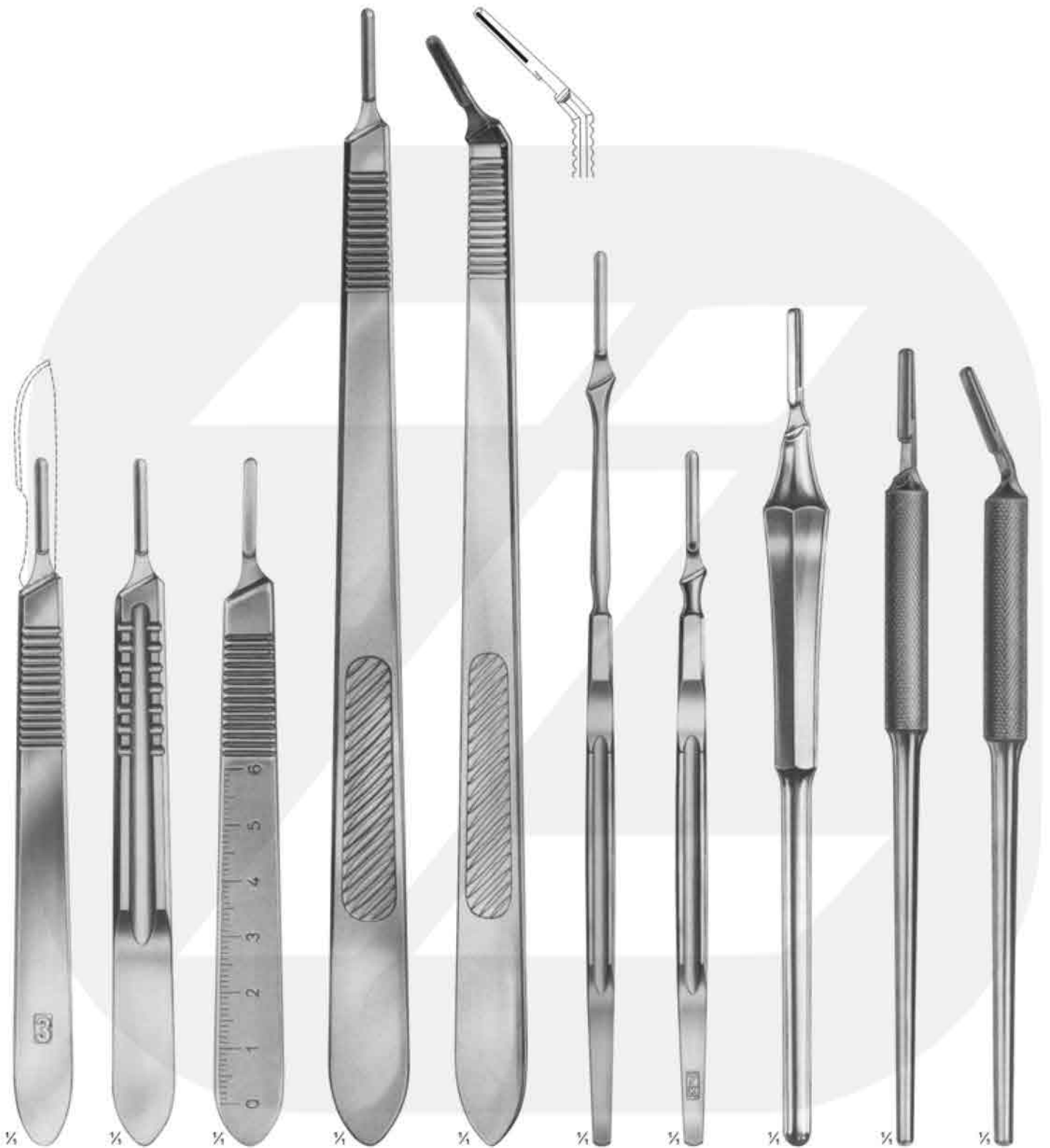

02-130 STANDARD No. 3 Solid 12 cm	02-131 No. 3 Solid 12 cm	02-132 No. 3 Solid 12 cm	02-133 No. 3 L Straight Solid 21.5 cm	02-134 No. 3 L Angled Solid 21 cm	02-135 No. 7 Solid 16 cm	02-136 No. 7 K Solid 12.5 cm	02-137 Hollow-Round 15.5 cm	02-138 No. 3 Straight Solid, Round 14.5 cm	02-139 No. 3 Angled Solid, Round 14 cm
---	-----------------------------------	-----------------------------------	---	---	-----------------------------------	---------------------------------------	-----------------------------------	---	---

# Micro Scissors (Spring Type) with Flat Handles

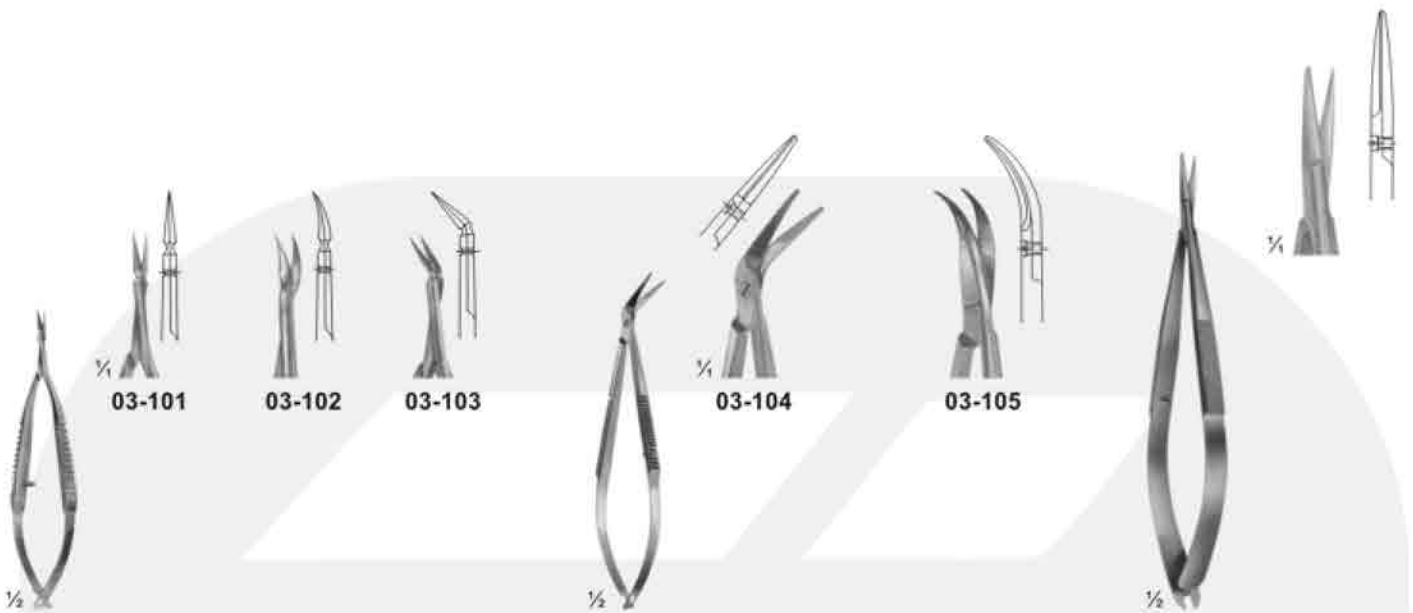

**03-101 - 103**  
VANNAS  
Size: 85 mm

**03-104 - 105**  
CASTROVIEJO  
Size: 95 mm

**03-106**  
NOYES  
Size: 125 mm

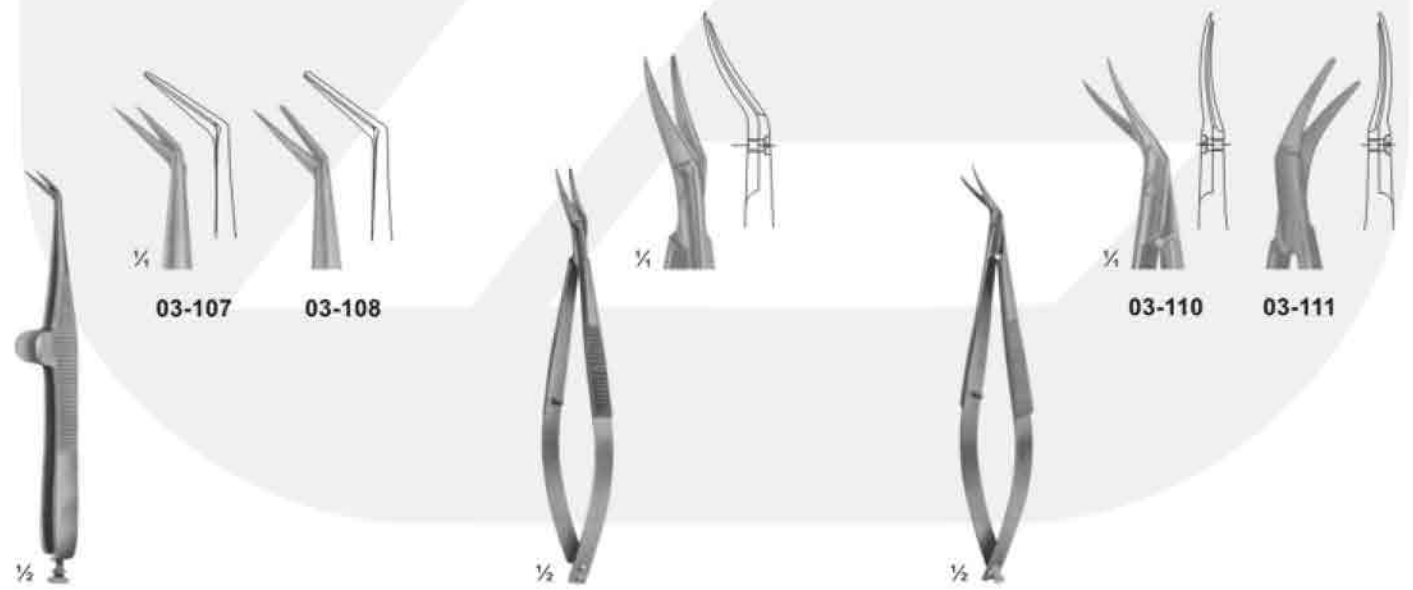

**03-107 - 108**  
WECKER  
Eye scissor  
Size: 110 mm

**03-109**  
CASTROVIEJO  
Eye scissor  
Size: 115 mm

**03-110 - 111**  
CASTROVIEJO  
Eye scissor  
Size: 110 mm

## Micro Scissors (Spring Type) with Flat Handles

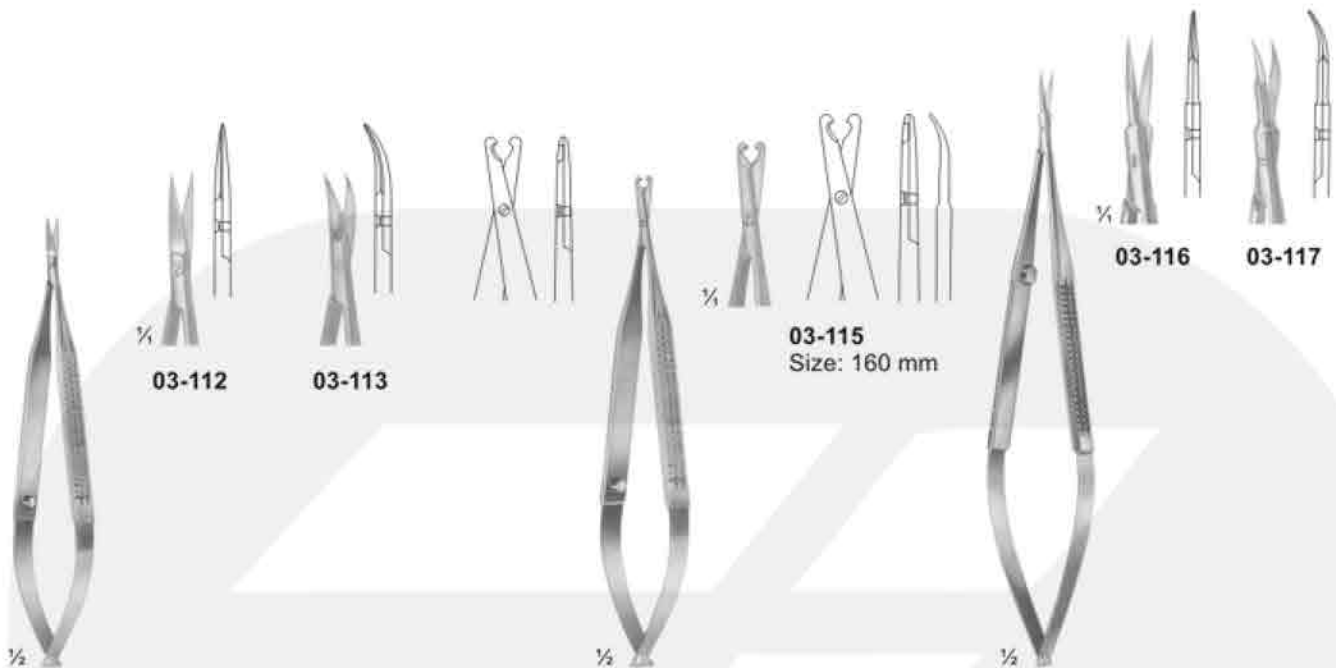

03-112

03-113

03-115  
Size: 160 mm

03-116

03-117

03-112 - 113  
Size: 120 mm

03-114  
BIEMER  
Vein scissor  
Size: 130 mm

03-116 - 117  
VANNAS  
Size: 160 mm

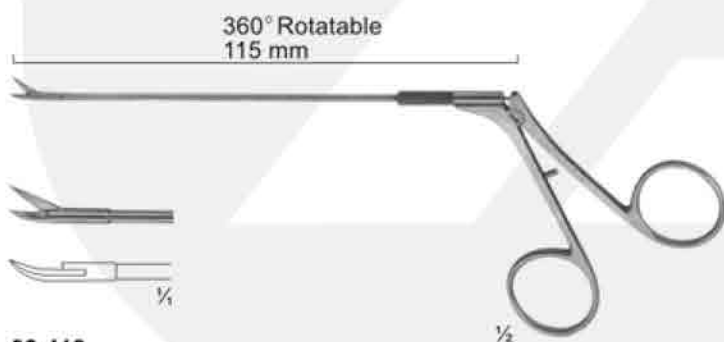

360° Rotatable  
115 mm

03-118  
CASPAR  
Micro scissor curved  
Size: 115 mm

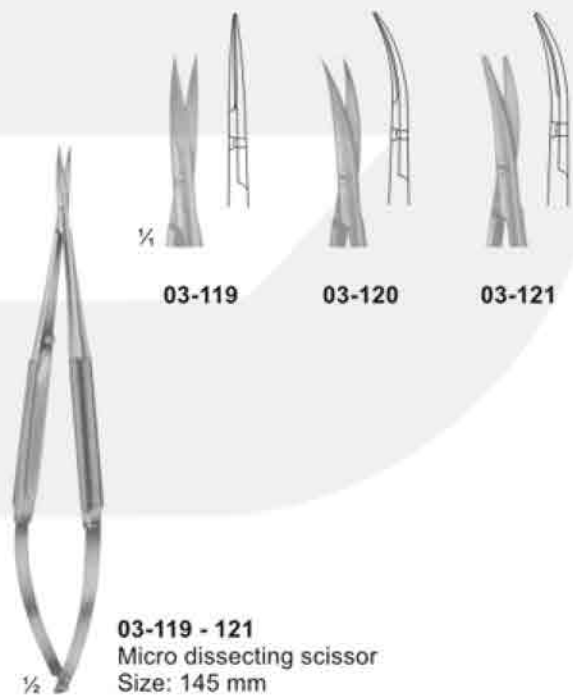

03-119

03-120

03-121

03-119 - 121  
Micro dissecting scissor  
Size: 145 mm

**Micro Scissors (Spring Type) bayonet-Shaped**



1/4  
**03-122**  
YASARGIL  
Size: 245 mm



1/4  
**03-123**  
45°



1/4  
**03-124**  
45°



1/4  
**03-123 - 124**  
laterally angled  
Size: 200 mm



1/4  
**125°**



1/4  
**03-125**  
laterally angled  
Size: 190 mm



1/4  
**03-126**



1/4  
**03-127**



1/4  
**03-126 - 127**  
YASARGIL  
Size: 225 mm



## Delicate Scissors

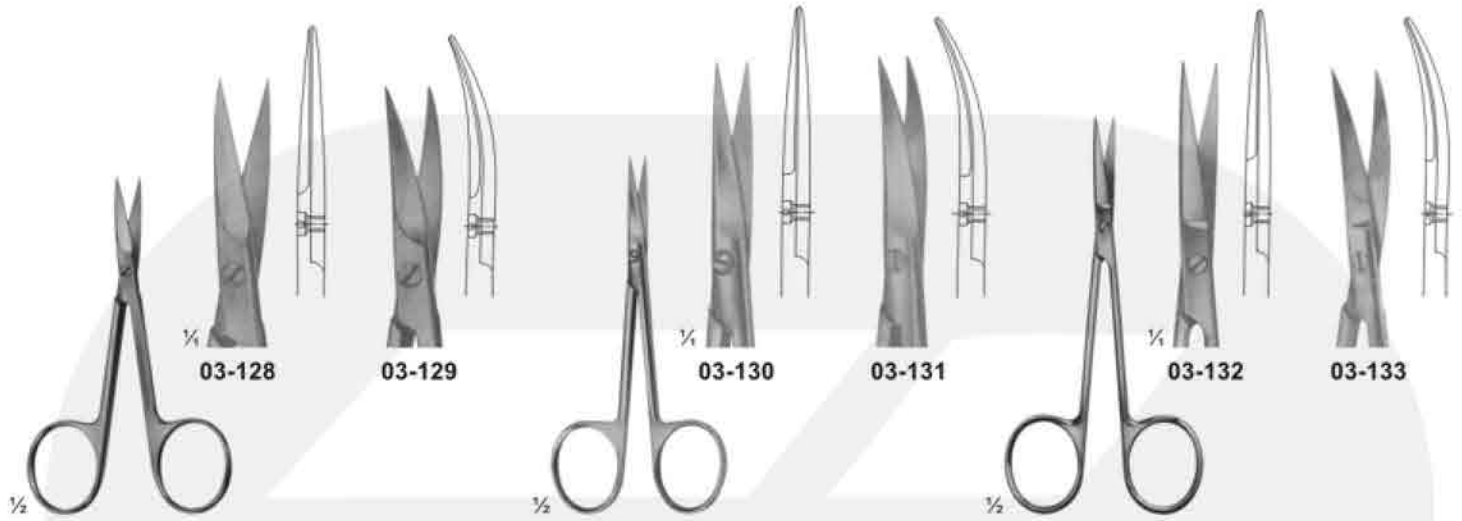

**03-128 - 129**  
Size: 90 mm

**03-130 - 131**  
Size: 95 mm

**03-132 - 133**  
Size: 105 mm



**03-134 - 135**  
Size: 120 mm

**03-136 - 137**  
Size: 115 mm

## Delicate Scissors

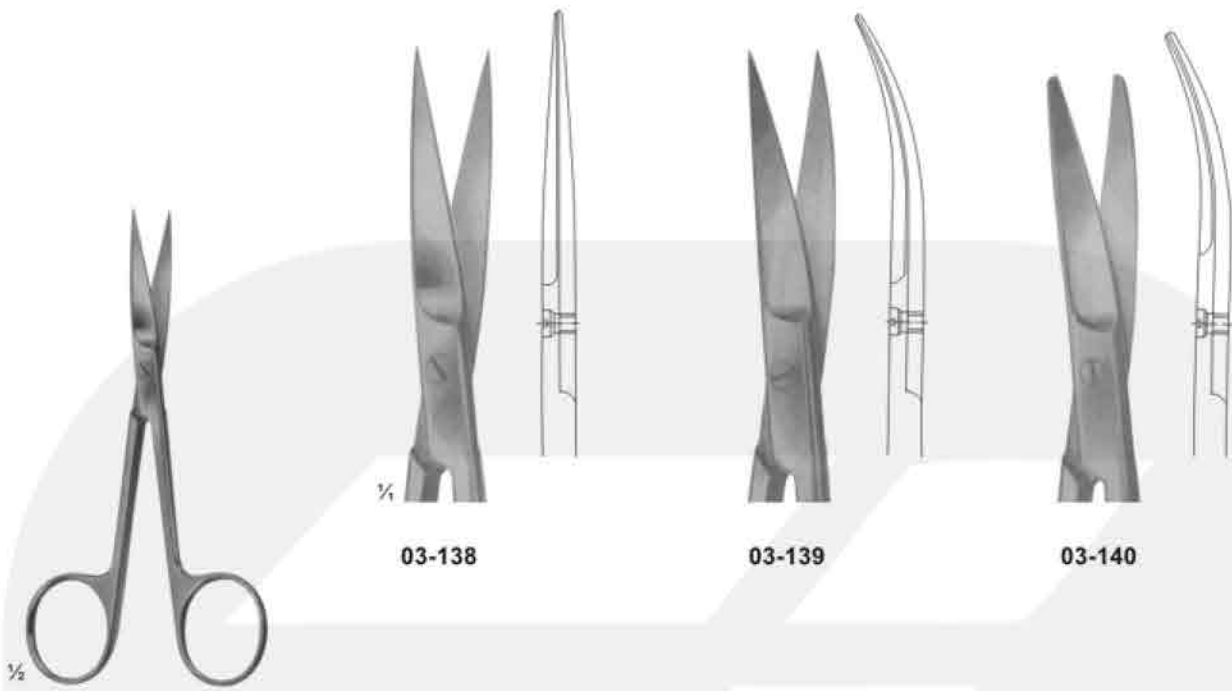

03-138

03-139

03-140

03-138 - 140  
Size: 120 mm

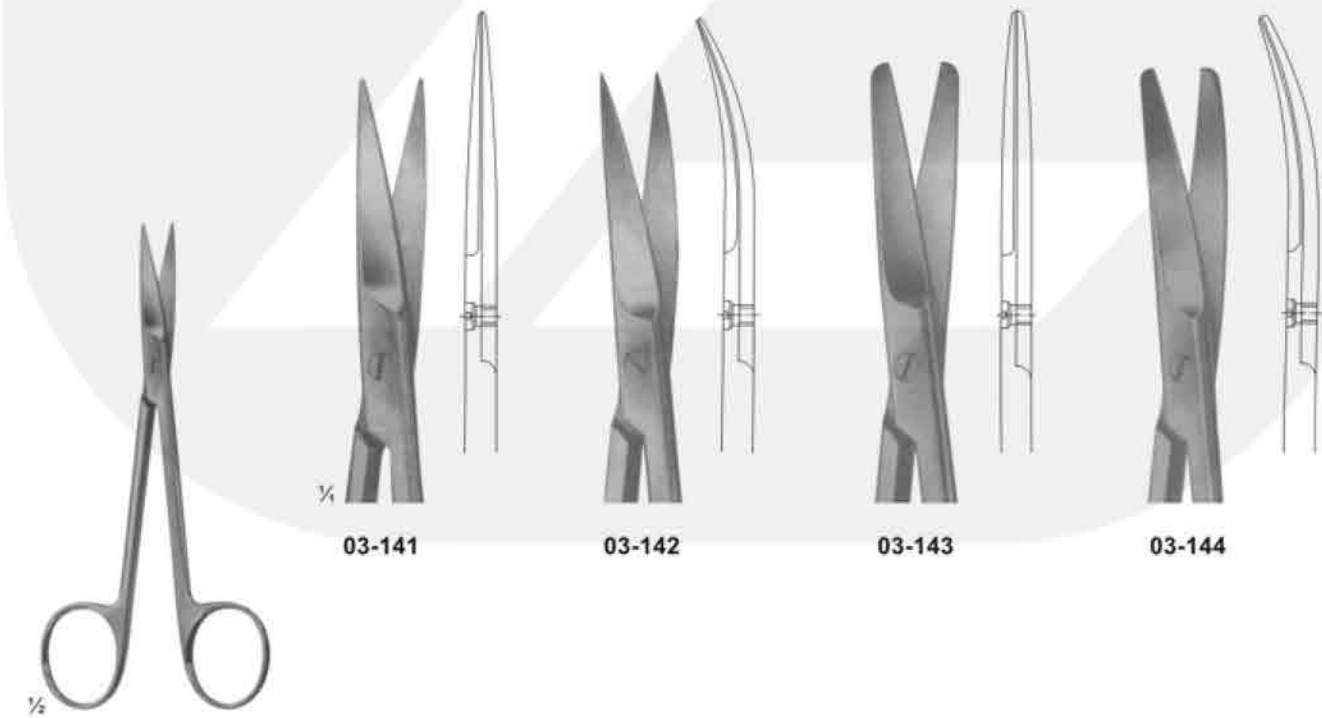

03-141

03-142

03-143

03-144

03-141 - 144  
Size: 130 mm

# Surgical Scissors



**03-145 - 153 (Standard types)**  
 03-145 ( 105 mm )  
 03-146 ( 115 mm )  
 03-147 ( 130 mm )  
 03-148 ( 145 mm )  
 03-149 ( 150 mm )  
 03-150 ( 165 mm )  
 03-151 ( 175 mm )  
 03-152 ( 185 mm )  
 03-153 ( 200 mm )

**03-145**  
 Size: 105 mm

**03-153**  
 Size: 200 mm

**03-154 - 160 (Standard types)**  
 03-154 ( 115 mm )  
 03-155 ( 130 mm )  
 03-156 ( 145 mm )  
 03-157 ( 150 mm )  
 03-158 ( 165 mm )  
 03-159 ( 175 mm )  
 03-160 ( 185 mm )

**03-154**  
 Size: 115 mm

**03-160**  
 Size: 185 mm

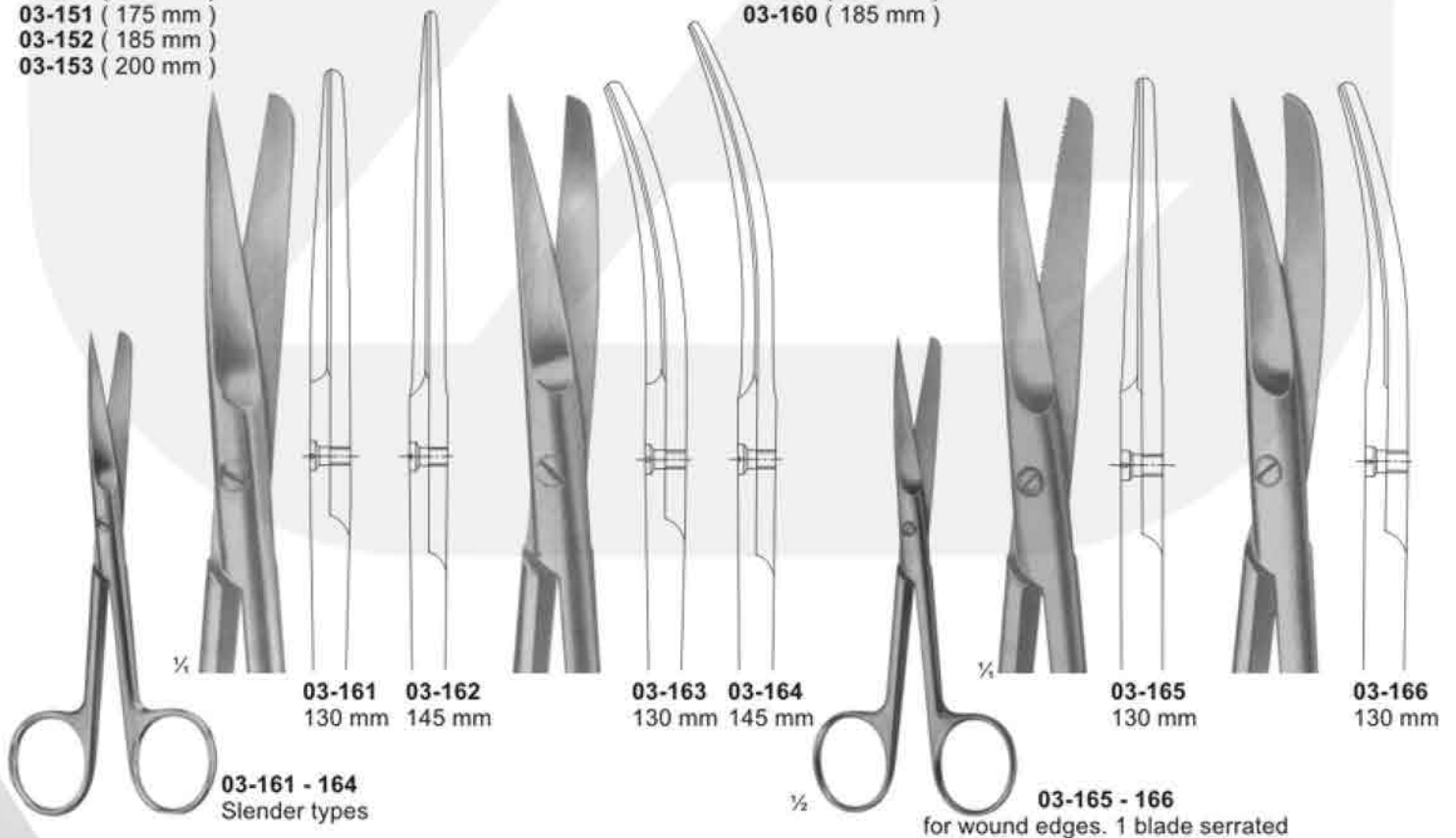

**03-161 03-162**  
 130 mm 145 mm

**03-163 03-164**  
 130 mm 145 mm

**03-165**  
 130 mm

**03-166**  
 130 mm

**03-161 - 164**  
 Slender types

**03-165 - 166**  
 for wound edges. 1 blade serrated

## Surgical Scissors



**03-167 - 169**  
DEAVER  
with flat lock

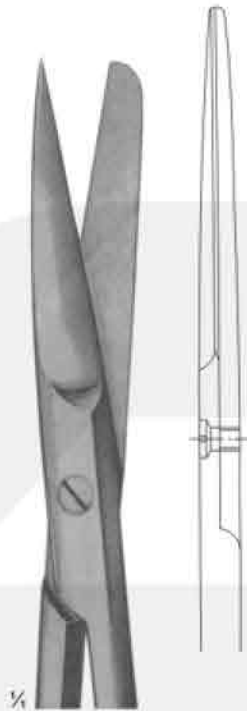

**03-167**  
Size: 145 mm

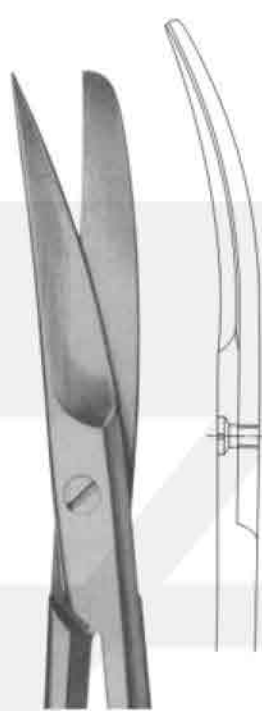

**03-168**  
Size: 145 mm

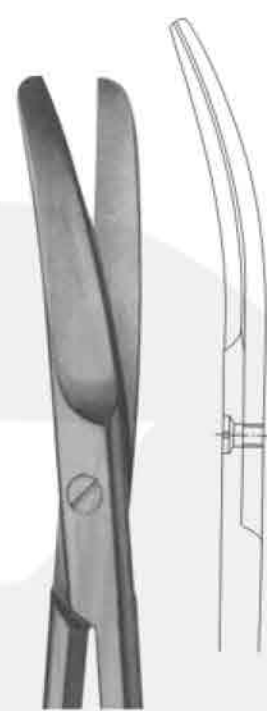

**03-169**  
Size: 145 mm



**03-170 - 172**  
Incision scissors



**03-170**  
Size: 130 mm

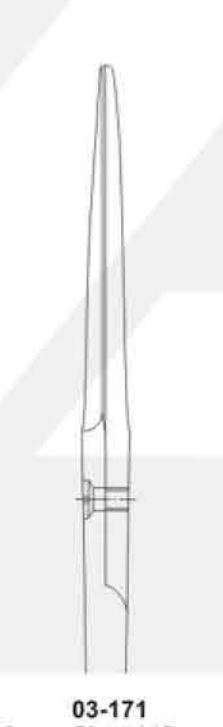

**03-171**  
Size: 145 mm

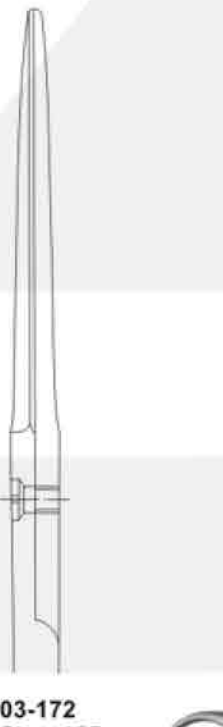

**03-172**  
Size: 165 mm



**03-173**  
SYSTRUNK  
Nail splitting scissors

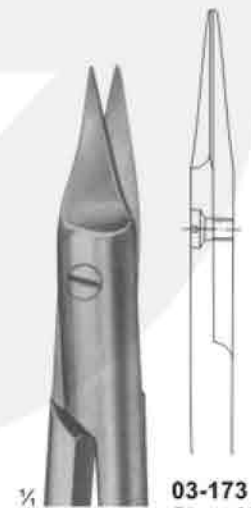

**03-173**  
Size: 130 mm



## Dissecting Scissors

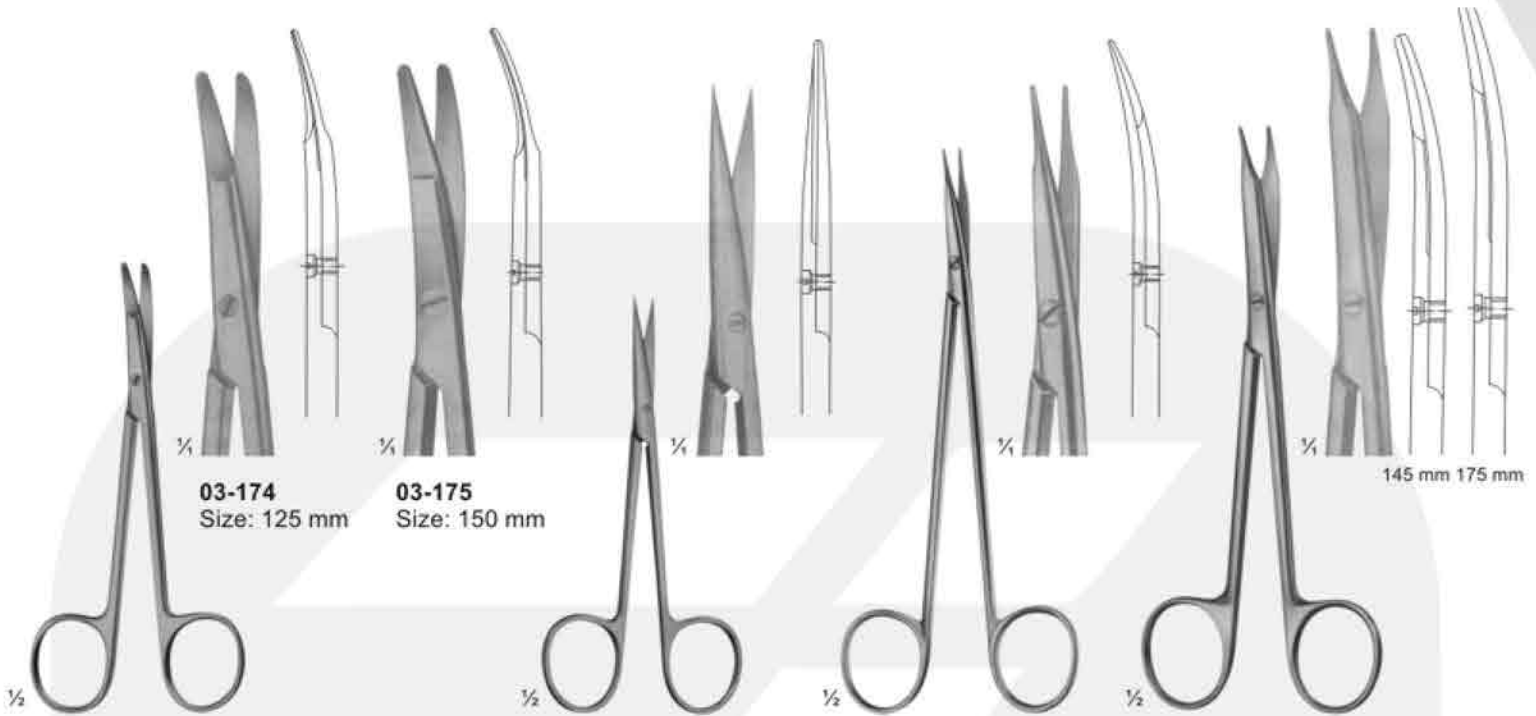

**03-174 - 175**  
**KILNER**  
Special flat points for dissecting and undermining the skin

**03-176**  
**KILNER**  
Fine dissecting scissors  
Size: 115 mm

**03-177**  
**JAMESON**  
Dissecting scissors  
Size: 150 mm

**03-178**  
**REYNOLDS**  
Dissecting scissors  
Size: 145 - 175 mm

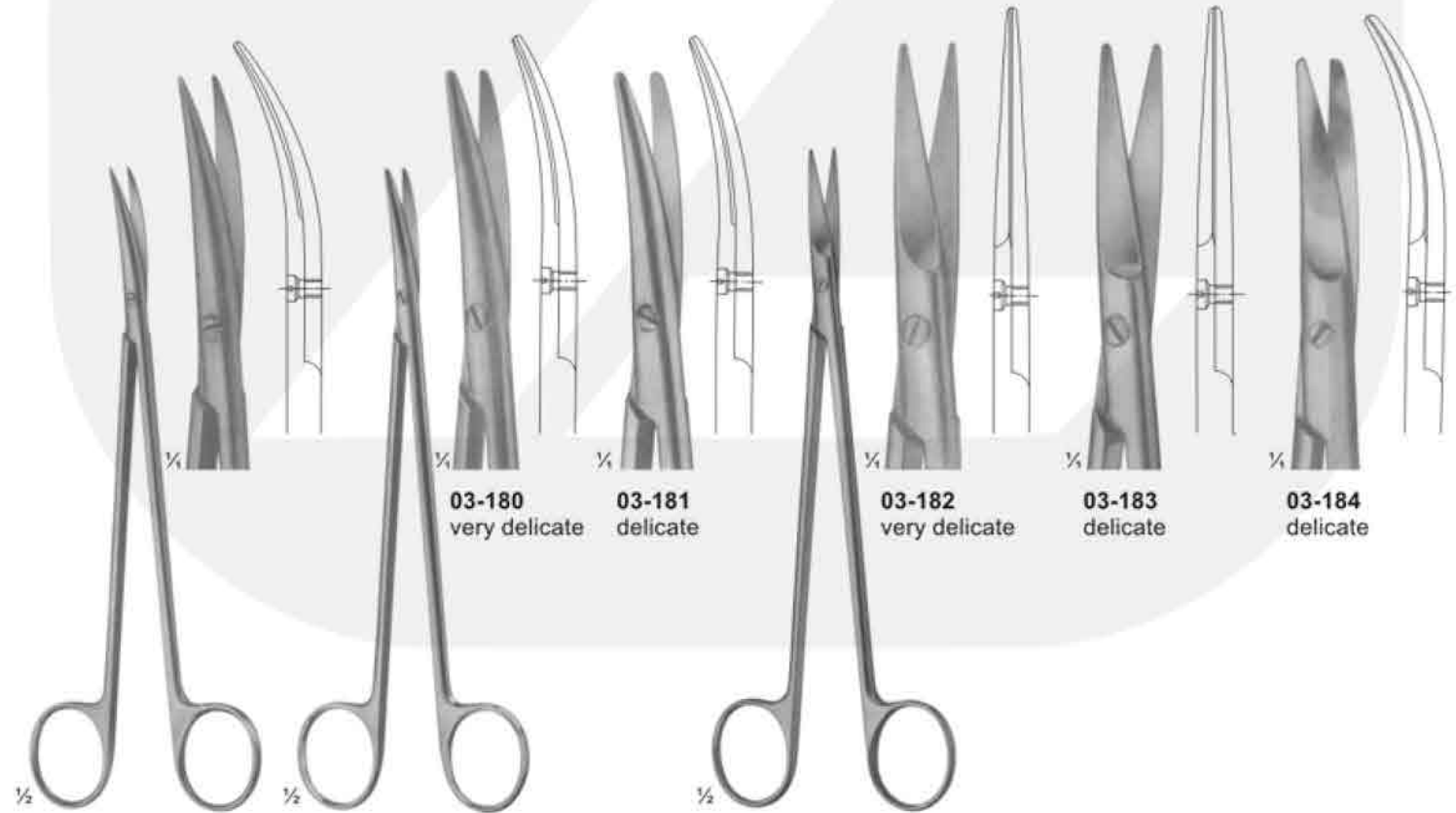

**03-179**  
**DE BAKEY**  
Arteriotomy scissors  
Size: 175 mm

**03-180 - 181**  
**TOENNIS ADSON**  
Dissecting scissors  
Size: 175 mm

**03-182 - 184**  
**TOENNIS**  
Dissecting scissors  
Size: 180 mm

## Dissecting Scissors

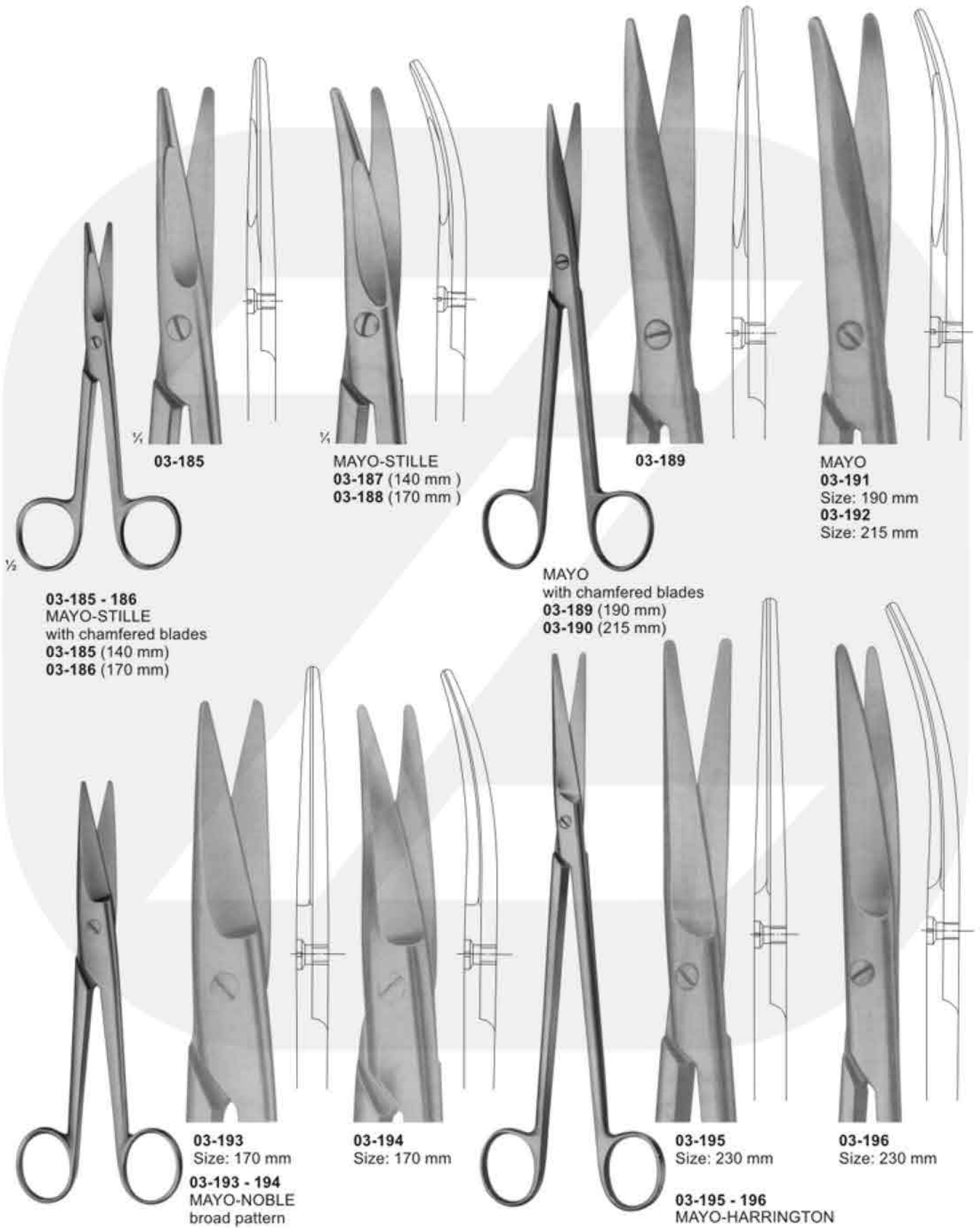

## Scissors for Cardiovascular and Neuro-Surgery

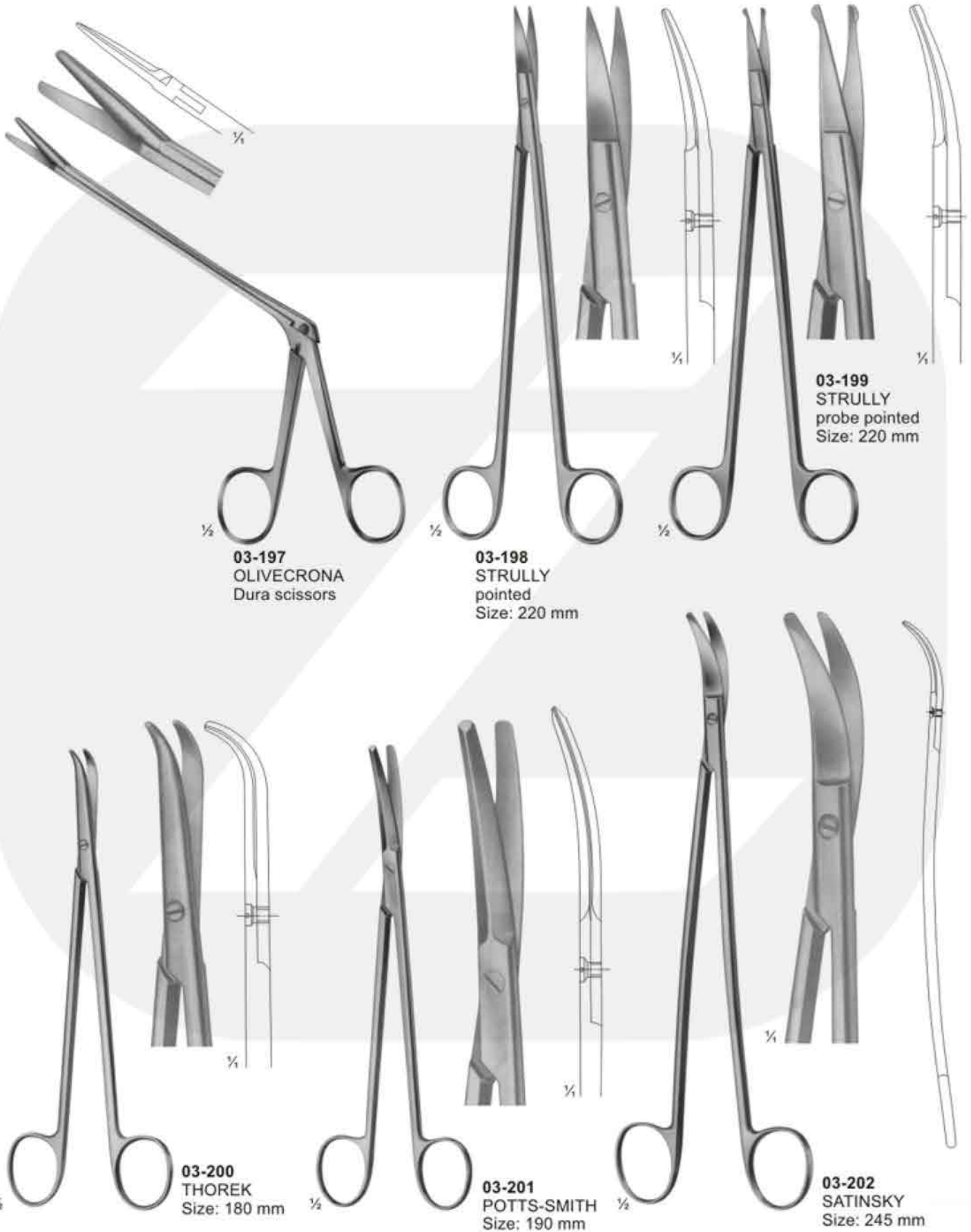



## Delicate, Nasal and Tonsil Scissors



**03-203**  
1 finely toothed blade  
Size: 130 mm

**03-204**  
LOCKLIN  
curved sideways,  
1 toothed blade  
Size: 155 mm

**03-205**  
FOMON  
blades serrated  
Size: 145 mm

**03-206**  
COTTLE  
Size: 165 mm



**03-207**  
HEYMANN-KNIGHT  
Size: 175 mm

**03-208**  
DEAN  
blades serrated  
Size: 170 mm

**03-209**  
GOOD  
Size: 195 mm



## Bone Shears

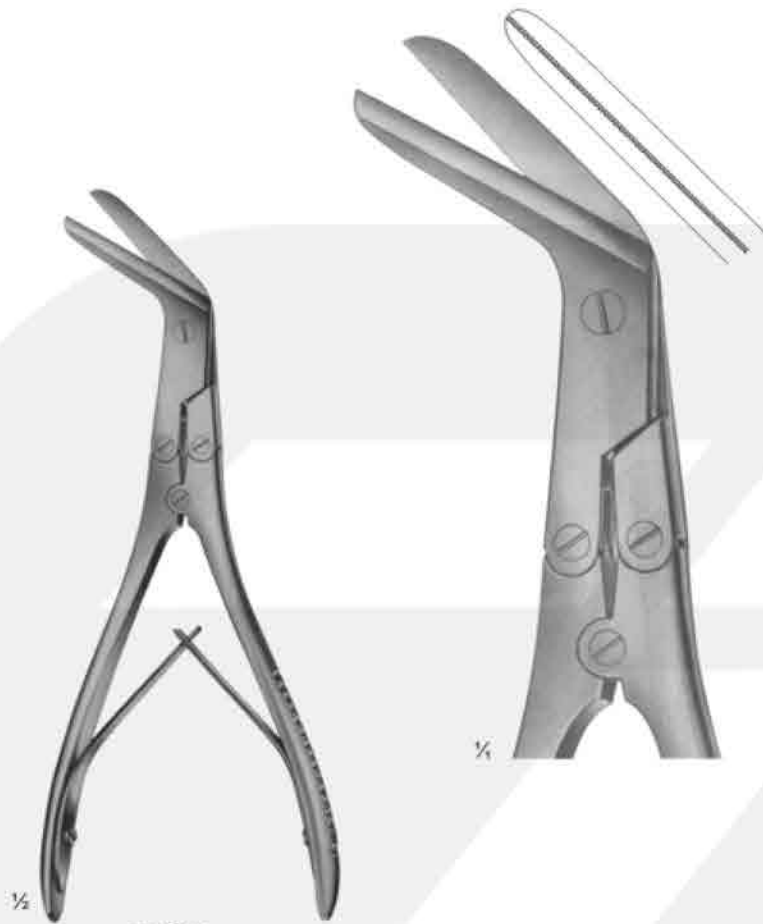

**03-210**  
KILLIAN  
Size: 200 mm



**03-211 - 03-212**

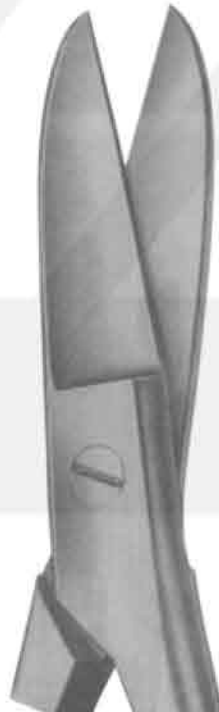

**03-211**  
195 mm



**03-212**  
225 mm



## Scissors for deep operations and for Gynaecology

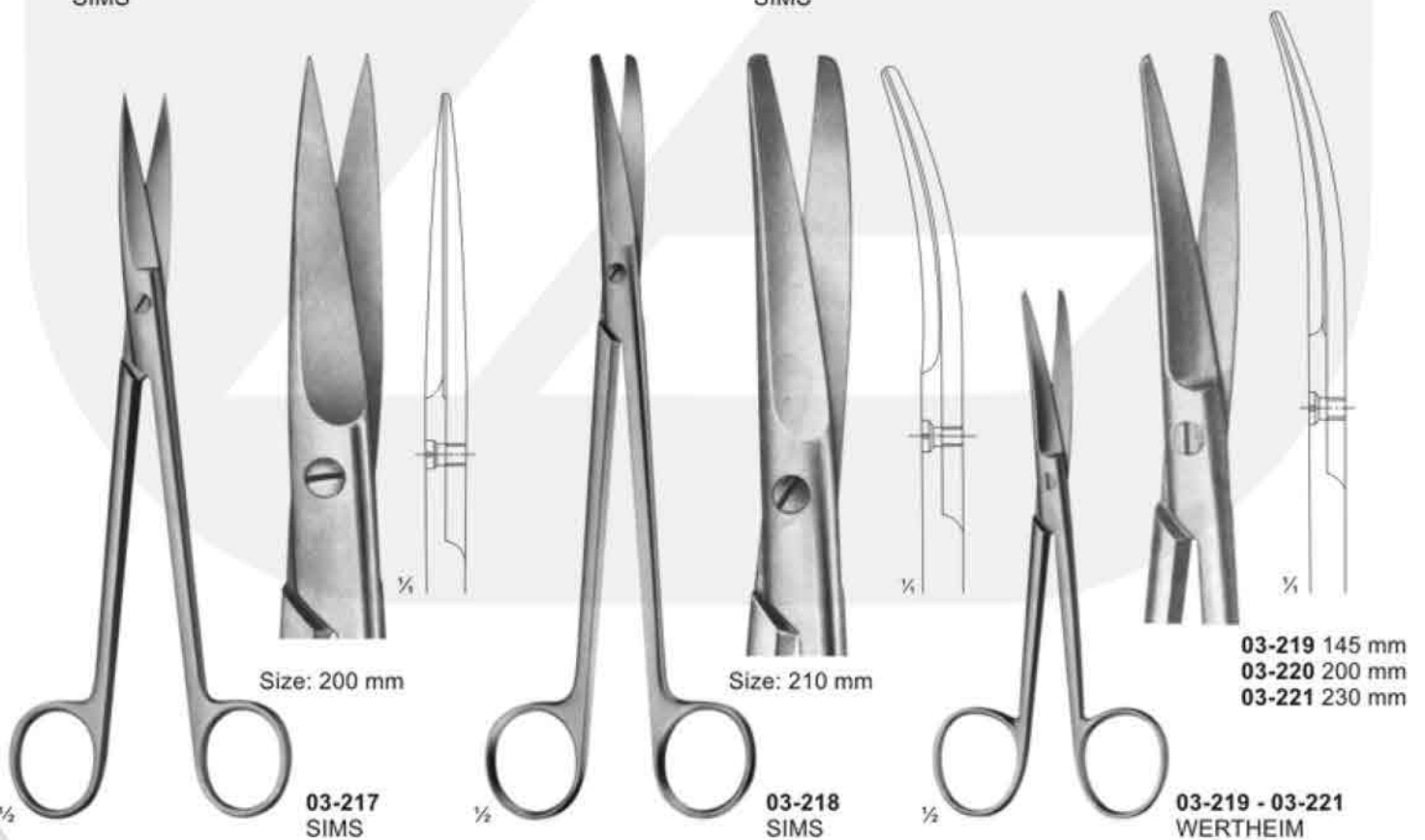
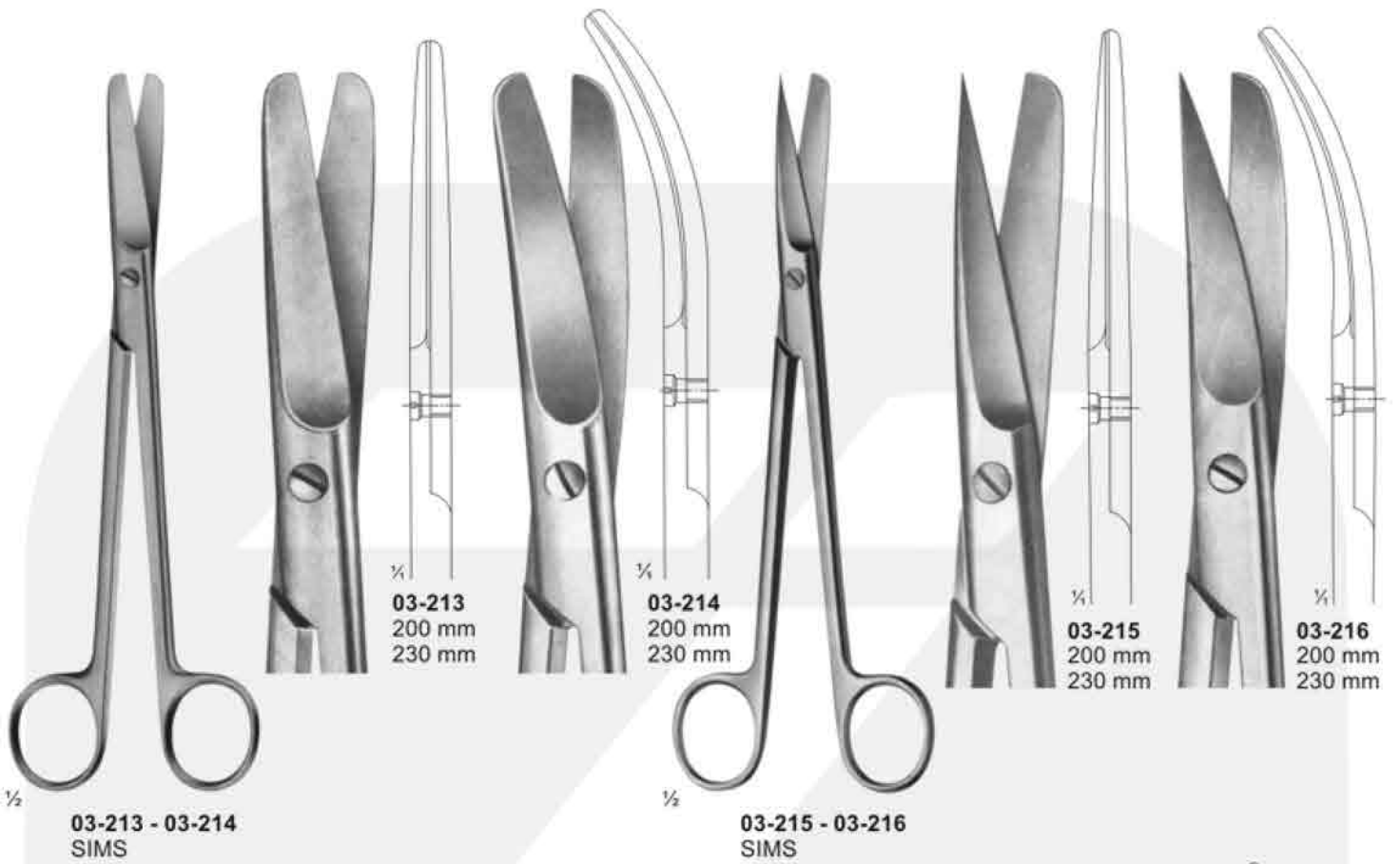

## Scissors for Obstetrics



**03-222**  
**SCHUMACHER**  
Umbilical cord scissors  
Size: 155 mm

**03-223**  
Umbilical cord scissors  
Size: 105 mm

**03-224**  
Umbilical cord scissors  
135 mm



**03-225 - 03-226**  
**BRAUN-STADLER**  
Episiotomy scissors

**03-225**  
145 mm

**03-226**  
200 mm

**03-227**  
Episiotomy scissors  
240 mm

## Wire and Plate Scissors

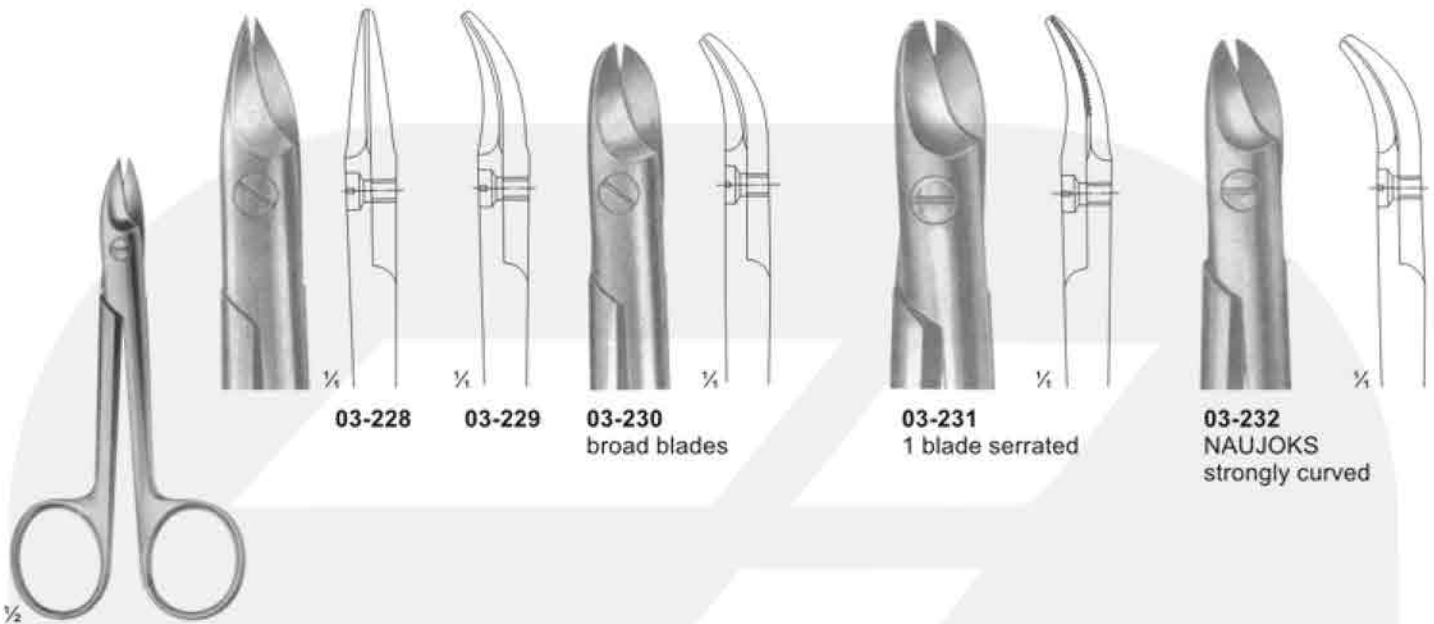

03-228

03-229

03-230  
broad blades

03-231  
1 blade serrated

03-232  
NAUJOKS  
strongly curved

03-228 - 03-232  
BEEBE  
Size: 110 mm

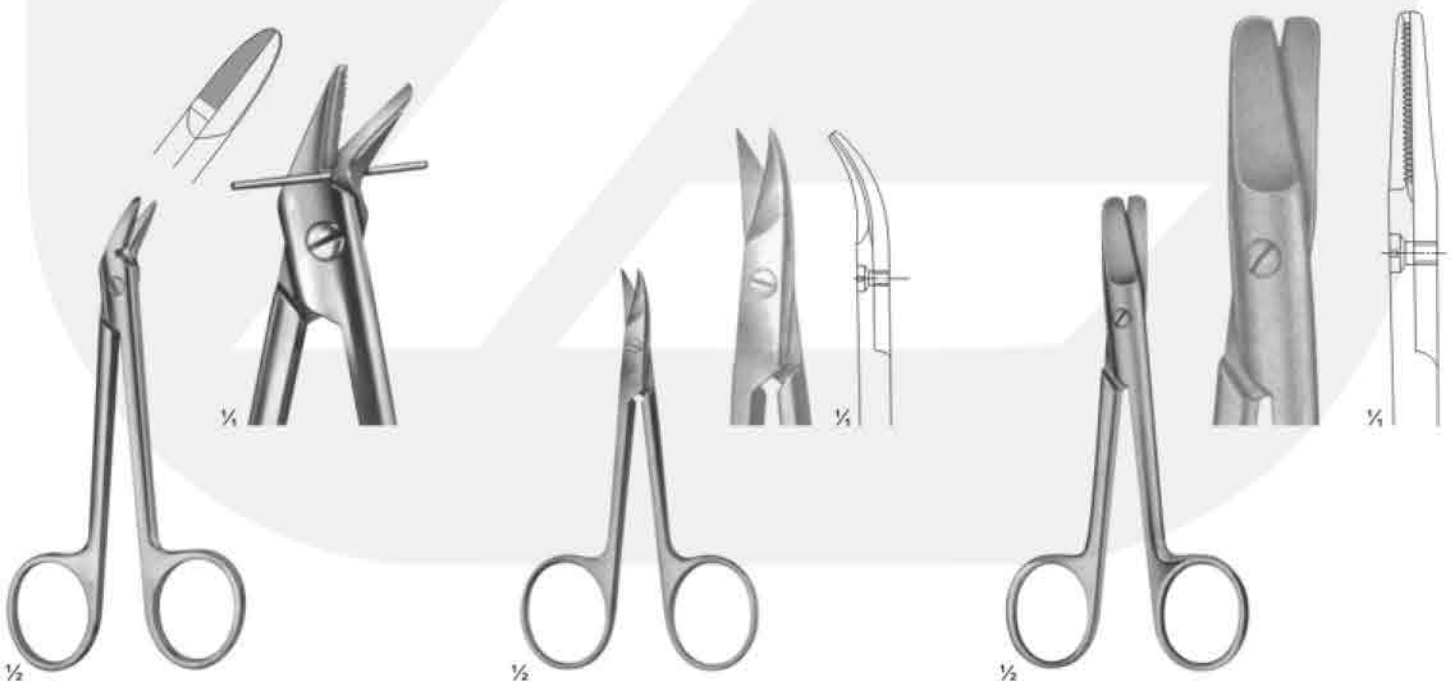

03-233  
1 blade serrated  
Size: 120 mm

03-234  
STRACK  
Size: 100 mm

03-235  
HARVEY  
blades serrated  
Size: 125 mm



## Bandage and Cloth Scissors



**03-236**  
Universal bandage and cloth scissors,  
with toothed edges  
180 mm

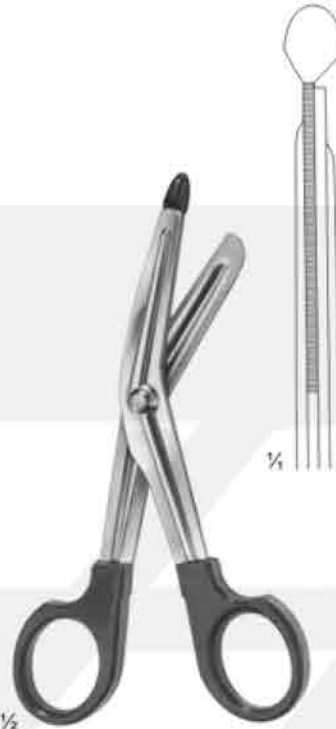

**03-237**  
LISTER  
Universal bandage and cloth scissors,  
with toothed edges  
Size: 145 mm

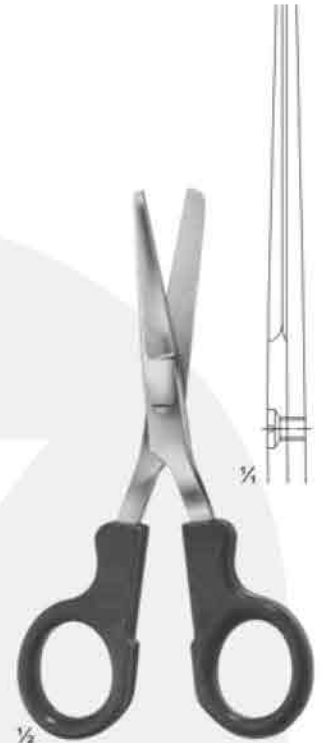

**03-238**  
LISTER  
Nurse's scissors  
Size: 145 mm

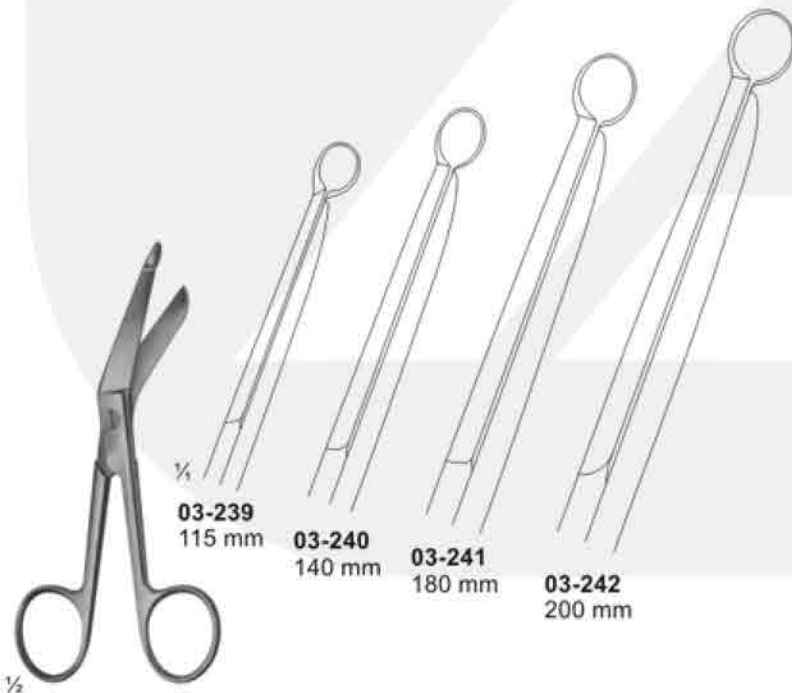

**03-239 - 03-242**  
LISTER

**03-239**  
115 mm

**03-240**  
140 mm

**03-241**  
180 mm

**03-242**  
200 mm

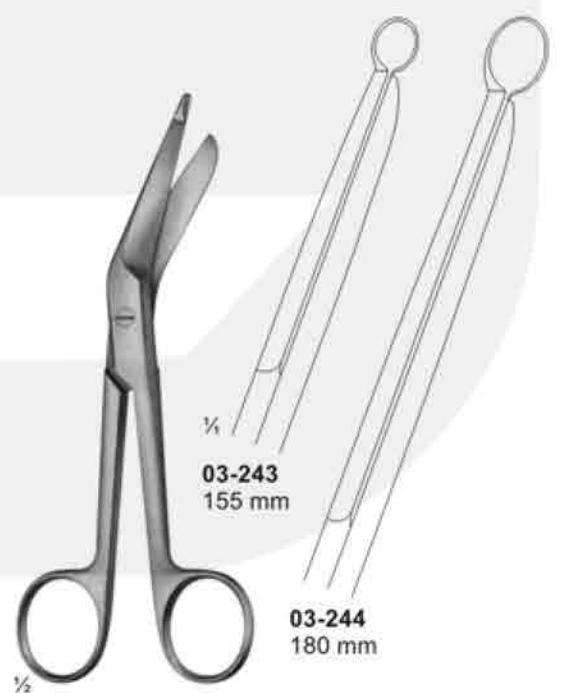

**03-243 - 03-244**  
LISTER

**03-243**  
155 mm

**03-244**  
180 mm

## Bandage-, Cloth-, and Plaster Scissors

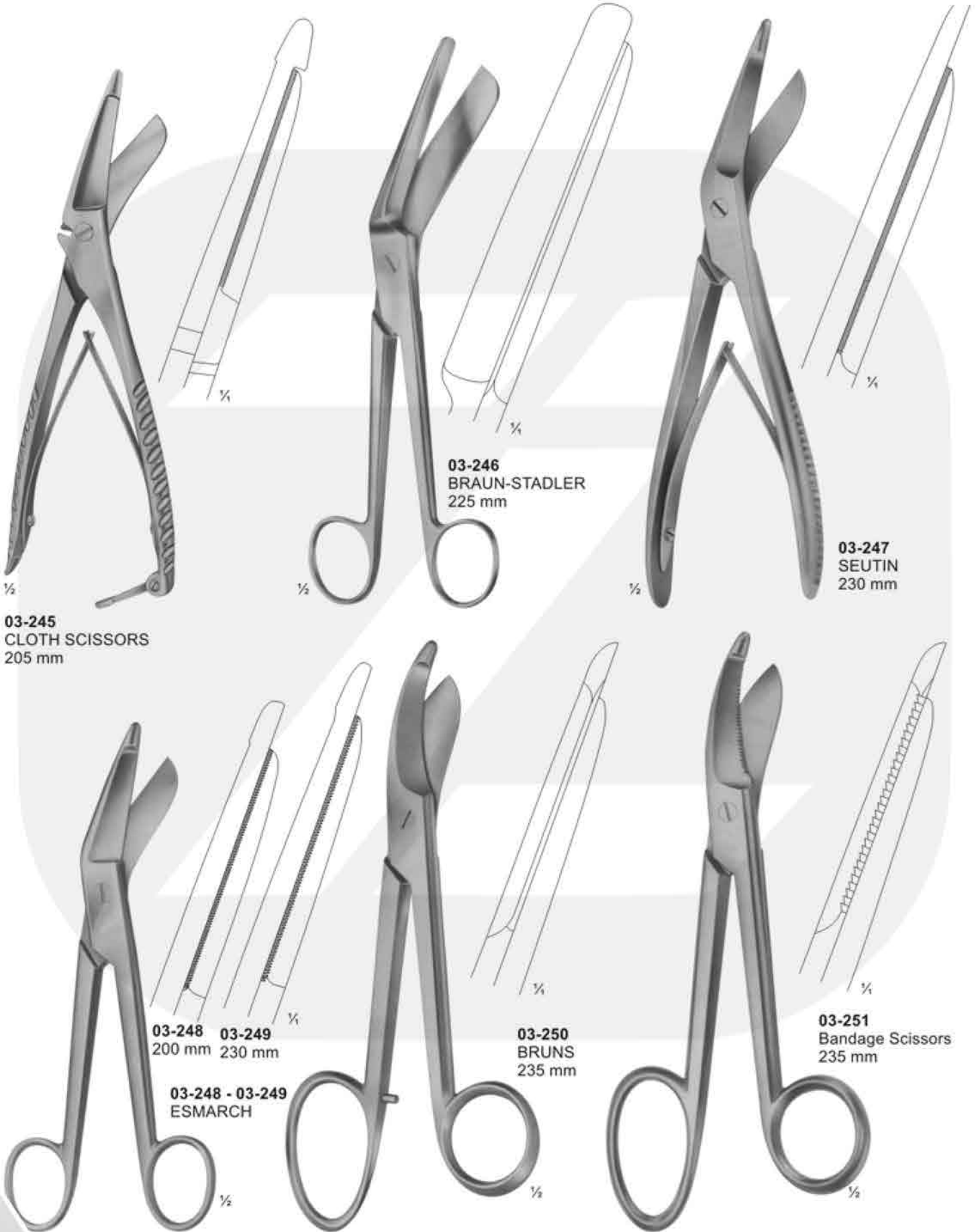

**03-245**  
CLOTH SCISSORS  
205 mm

**03-246**  
BRAUN-STADLER  
225 mm

**03-247**  
SEUTIN  
230 mm

**03-248** 200 mm  
**03-249** 230 mm

**03-248 - 03-249**  
ESMARCH

**03-250**  
BRUNS  
235 mm

**03-251**  
Bandage Scissors  
235 mm

**Forceps for grasping tissue, tumors etc.**

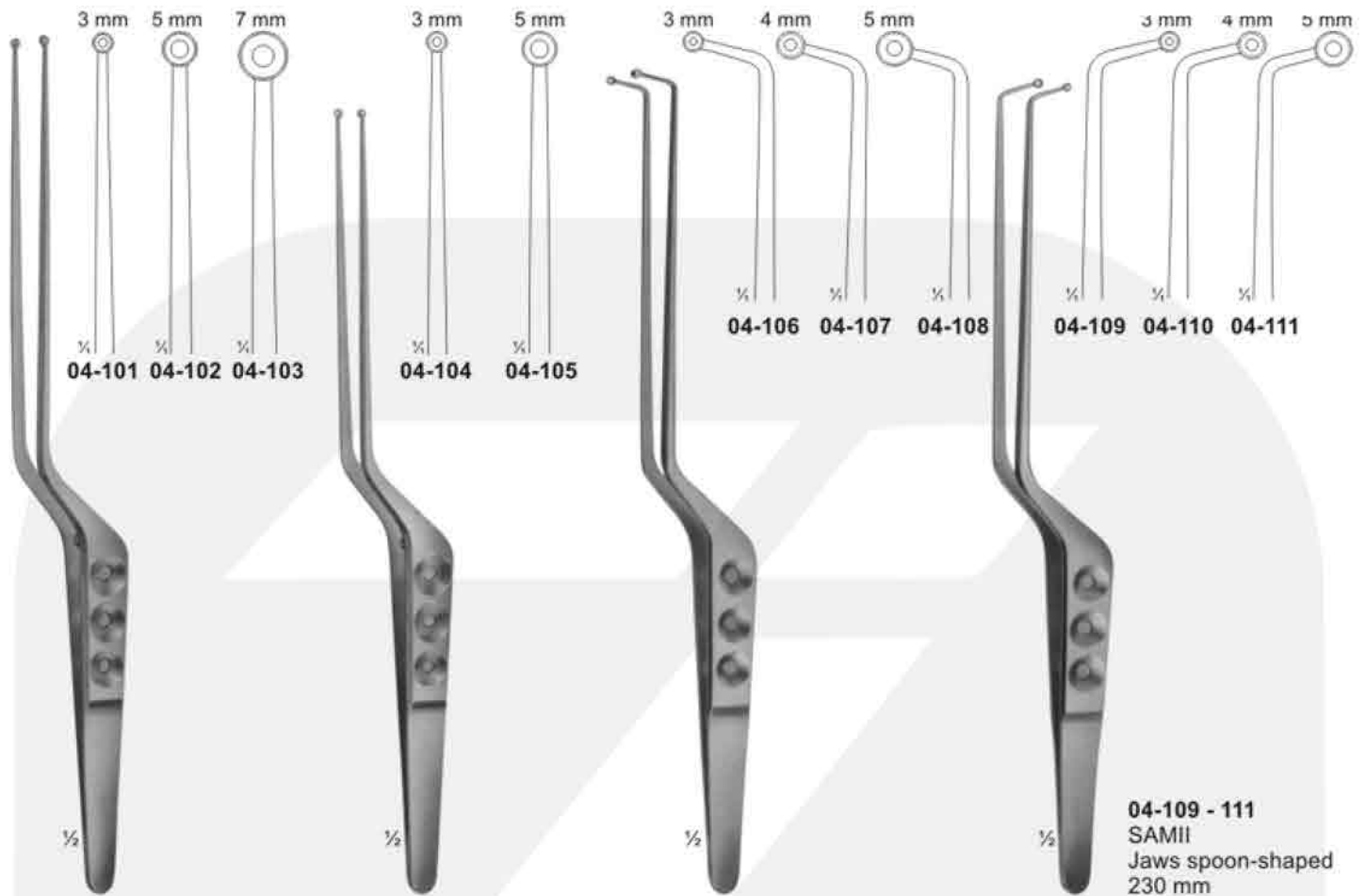

04-101 04-102 04-103

04-104 04-105

04-106 04-107 04-108

04-109 04-110 04-111

**04-101 - 103**  
YASARGIL-SAMII  
Jaws spoon-shaped  
240 mm

**04-104 - 105**  
YASARGIL  
Jaws spoon-shaped  
220 mm

**04-106 - 108**  
SAMII  
Jaws spoon-shaped  
230 mm

**04-109 - 111**  
SAMII  
Jaws spoon-shaped  
230 mm

**04-112**  
HUNT  
Tumor-and  
vessel forceps  
200 mm

**04-113**  
HUNT  
Tumor-and  
vessel forceps  
200 mm

**04-114**  
YASARGIL  
Tumor-and  
vessel forceps  
200 mm

# Delicate Dissecting, Microscopic, Sterilizing Forceps



**04-115**  
THORPE  
Corneal forceps  
120 mm

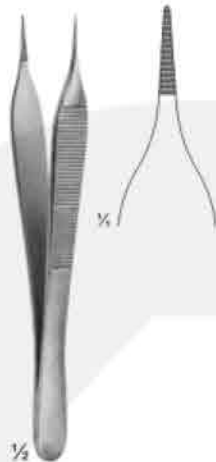

**04-116**  
MICRO-ADSON  
120 mm

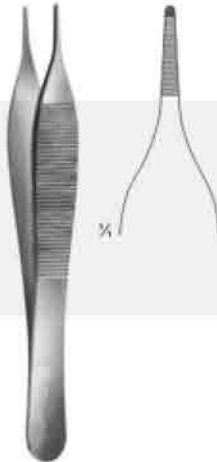

**04-117**  
ADSON  
120 mm



**04-118**  
MICRO-ADSON  
150 mm



**04-119 - 121**  
100 mm



**04-119**



**04-120**



**04-121**



**04-122**  
BONACCOLTO  
110 mm



**04-123**  
115 mm



**04-124 - 133**



**04-124**  
90 mm



**04-125**  
105 mm



**04-126**  
115 mm



**04-127**  
130 mm



**04-128**  
145 mm



**04-129**  
90 mm

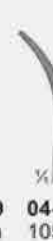

**04-130**  
105 mm

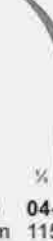

**04-131**  
115 mm



**04-132**  
130 mm

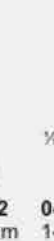

**04-133**  
145 mm



**04-134**  
100 mm

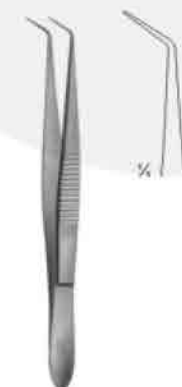

**04-135**  
100 mm



**04-136**  
100 mm



**04-137**  
KUHNE  
Cover glass forceps, 105 mm



**04-138**  
160 mm



## Delicate Dissecting Forceps

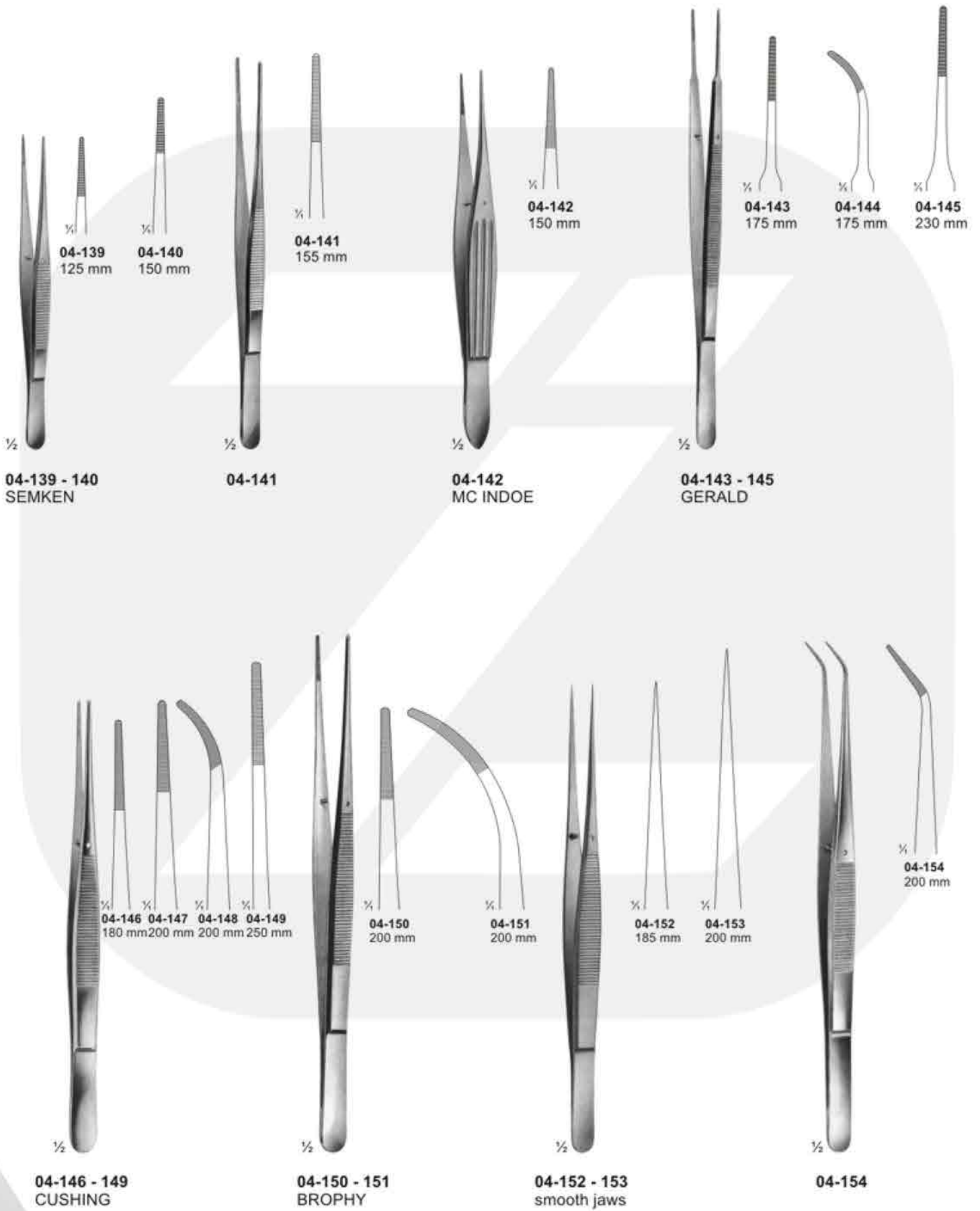

# Dissecting Forceps

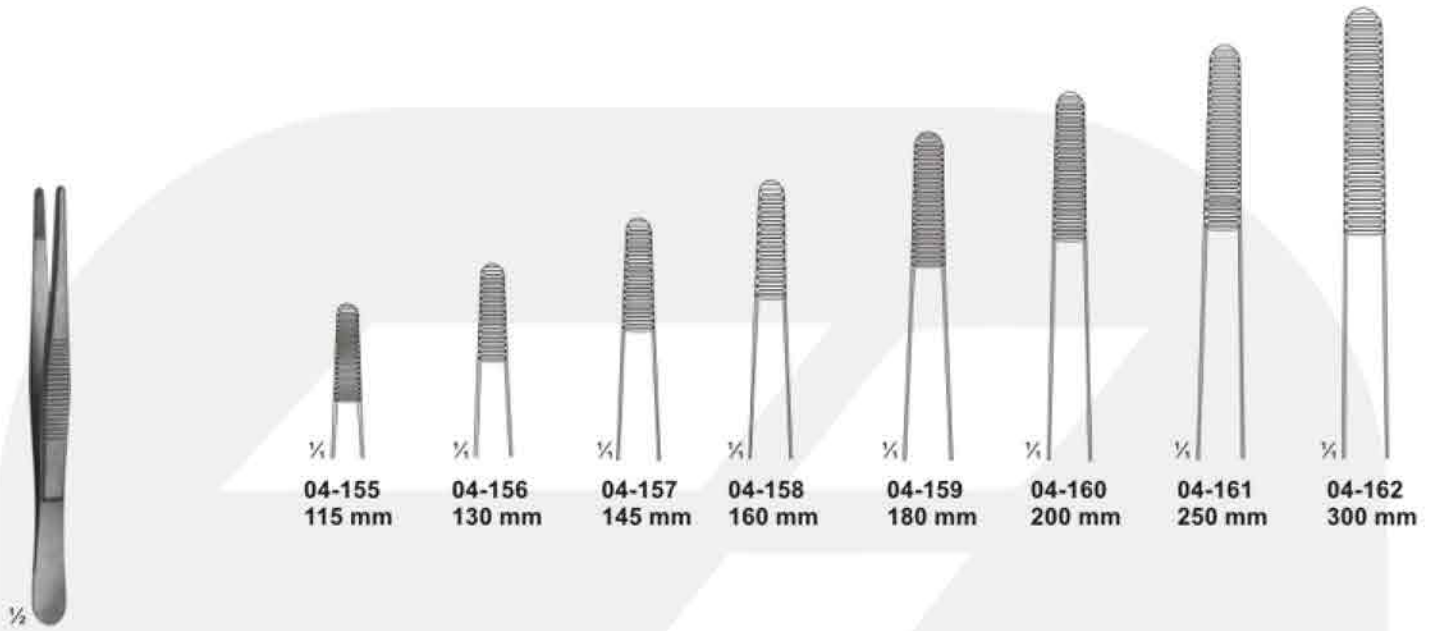

04-155 - 04-162  
STANDARD

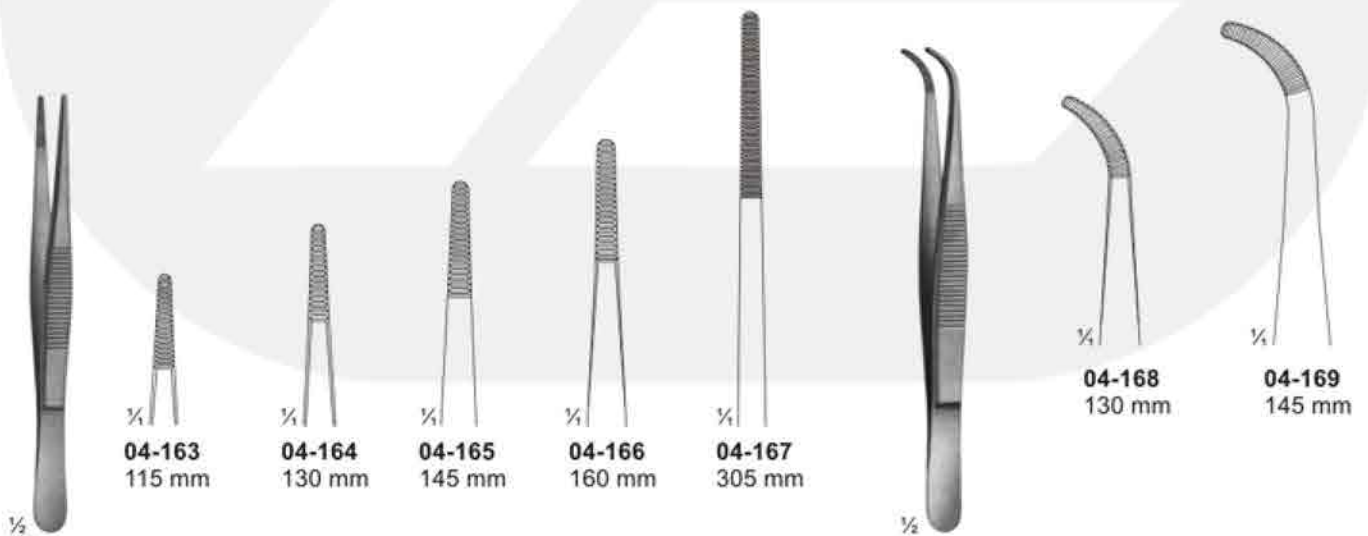

04-163 - 04-167  
MEDIUM

04-168 - 04-169  
MEDIUM



# Delicate Tissue Forceps



**04-185**  
BISHOP-HARMON  
85 mm

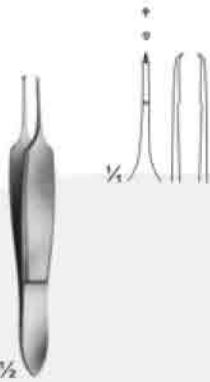

**04-186**  
ST.MARTIN  
80 mm

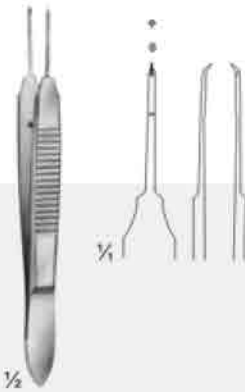

**04-187**  
CASTROVIEJO  
teeth 0.9 mm  
100 mm



**04-188**  
CASTROVIEJO  
teeth 0.5 mm  
100 mm

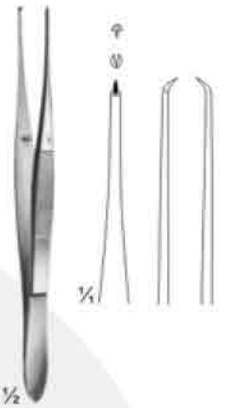

**04-189**  
ELSCHING  
110 mm



**04-190**  
GILL  
75 mm



**04-191**  
GILL - HESS  
75 mm

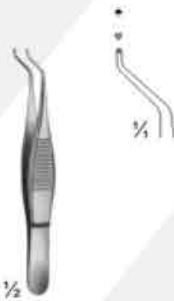

**04-192**  
HESS  
70 mm

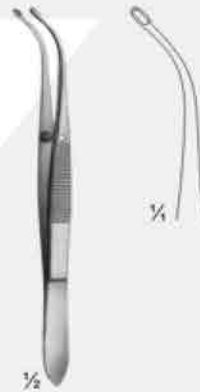

**04-193**  
ARRUGA  
100 mm



**04-194**  
SEMKEN  
125 mm 125 mm 150 mm  
2 X 3 teeth

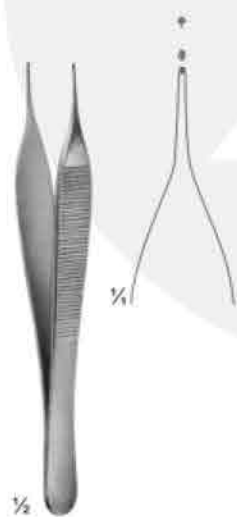

**04-195**  
MICRO-ADSON  
120 mm

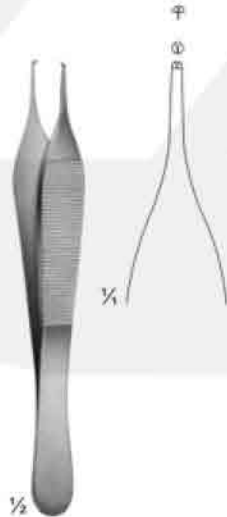

**04-196**  
ADSON  
120 mm



**04-197**  
ADSON  
120 mm

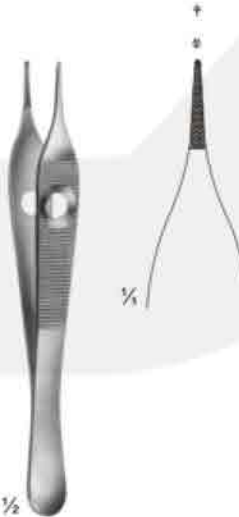

**04-198**  
ADSON  
120 mm

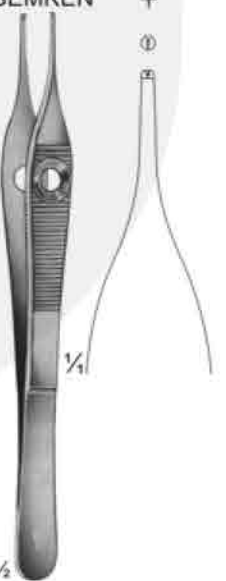

**04-199**  
ADSON  
150 mm



# Tissue Forceps

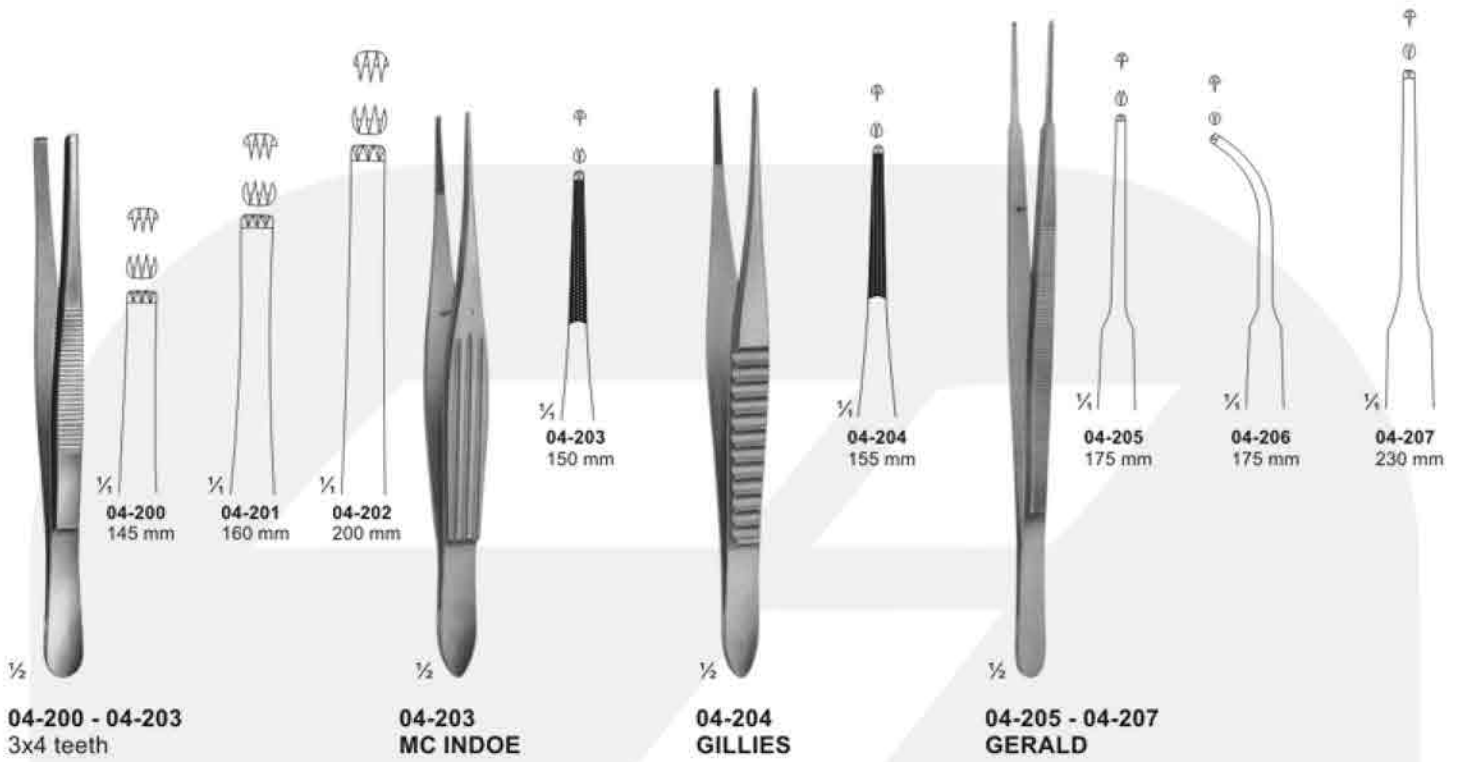

# Tissue Forceps

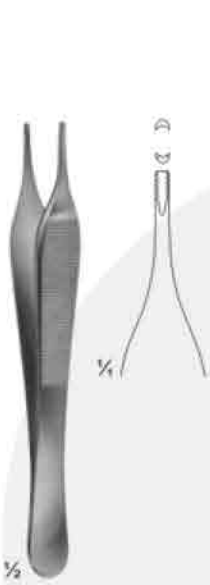

**04-213**  
**ADSON - BROWN**  
Non-traumatic  
120 mm



**04-214**  
**BROWN**  
120 mm



**04-215**  
**GRAEFE**  
110 mm

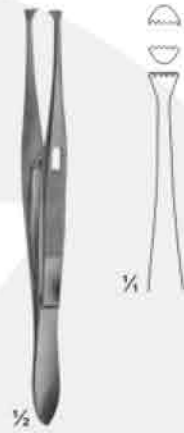

**04-216**  
**GRAEFE**  
With Catch  
110 mm

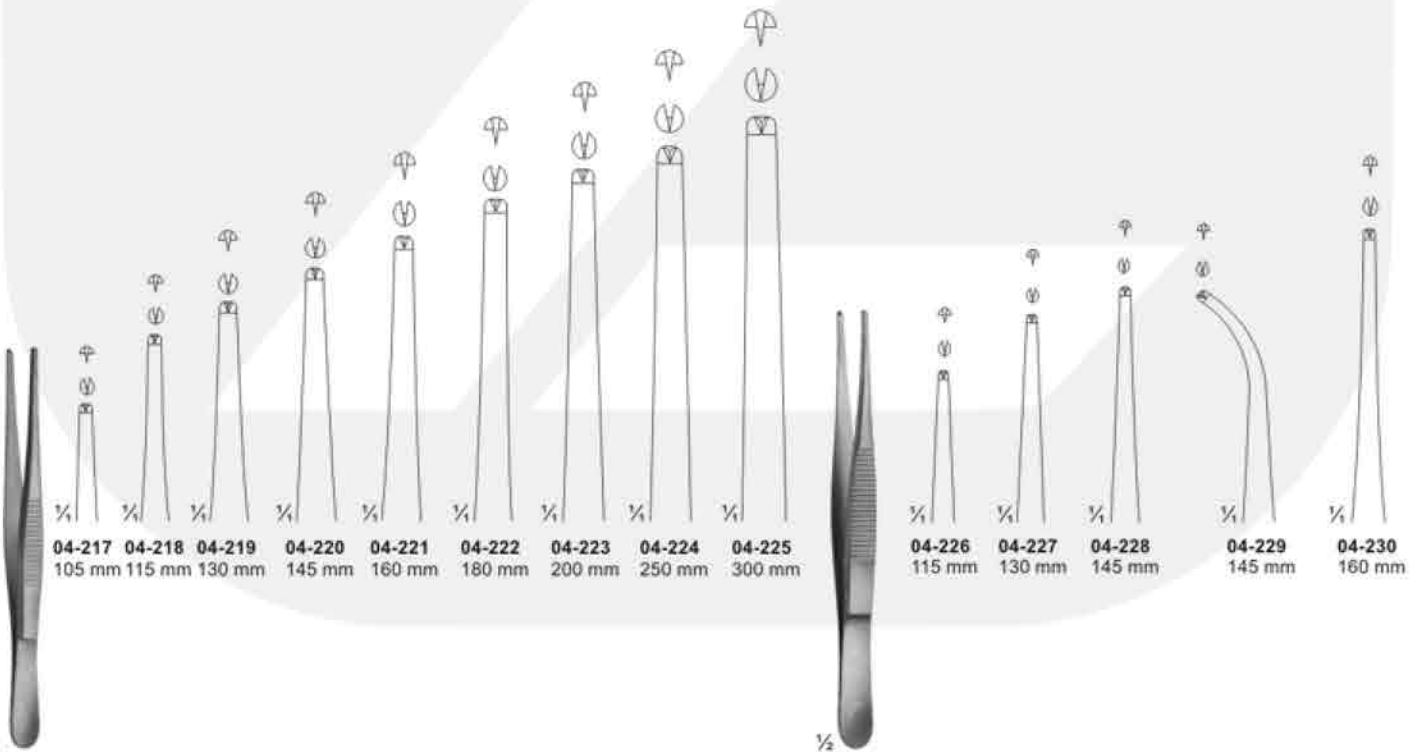

**04-217** 105 mm   **04-218** 115 mm   **04-219** 130 mm   **04-220** 145 mm   **04-221** 160 mm   **04-222** 180 mm   **04-223** 200 mm   **04-224** 250 mm   **04-225** 300 mm

**04-226** 115 mm   **04-227** 130 mm   **04-228** 145 mm   **04-229** 145 mm   **04-230** 160 mm

**04-217 - 04-225**  
**STANDARD**

**04-226 - 04-230**  
**GRAEFE**  
110 mm

# Forceps, Bayonet - Shaped

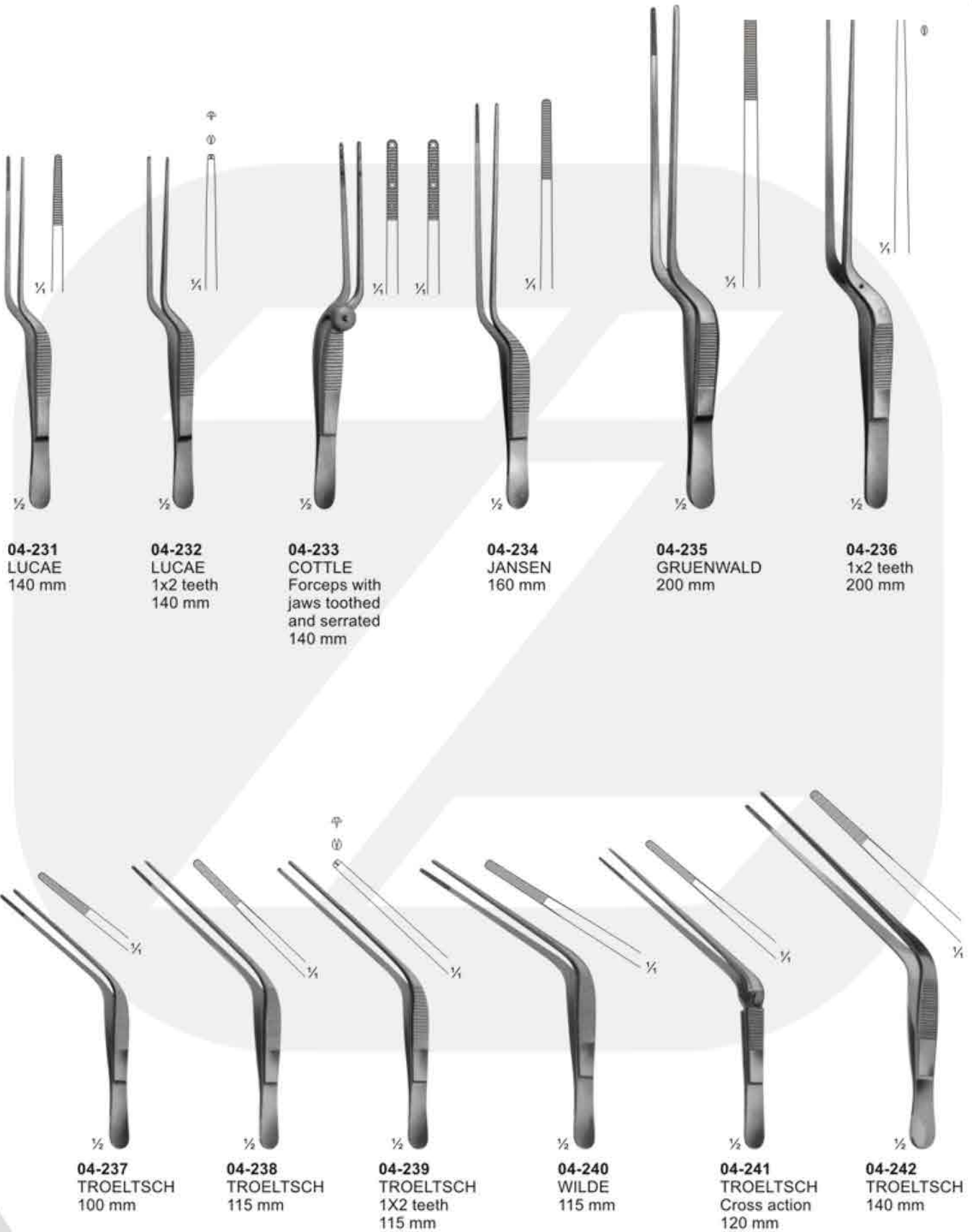

**04-231**  
LUCAE  
140 mm

**04-232**  
LUCAE  
1x2 teeth  
140 mm

**04-233**  
COTTLE  
Forceps with  
jaws toothed  
and serrated  
140 mm

**04-234**  
JANSEN  
160 mm

**04-235**  
GRUENWALD  
200 mm

**04-236**  
1x2 teeth  
200 mm

**04-237**  
TROELTSCH  
100 mm

**04-238**  
TROELTSCH  
115 mm

**04-239**  
TROELTSCH  
1X2 teeth  
115 mm

**04-240**  
WILDE  
115 mm

**04-241**  
TROELTSCH  
Cross action  
120 mm

**04-242**  
TROELTSCH  
140 mm

## Tissue Forceps, Lung Dissecting Forceps

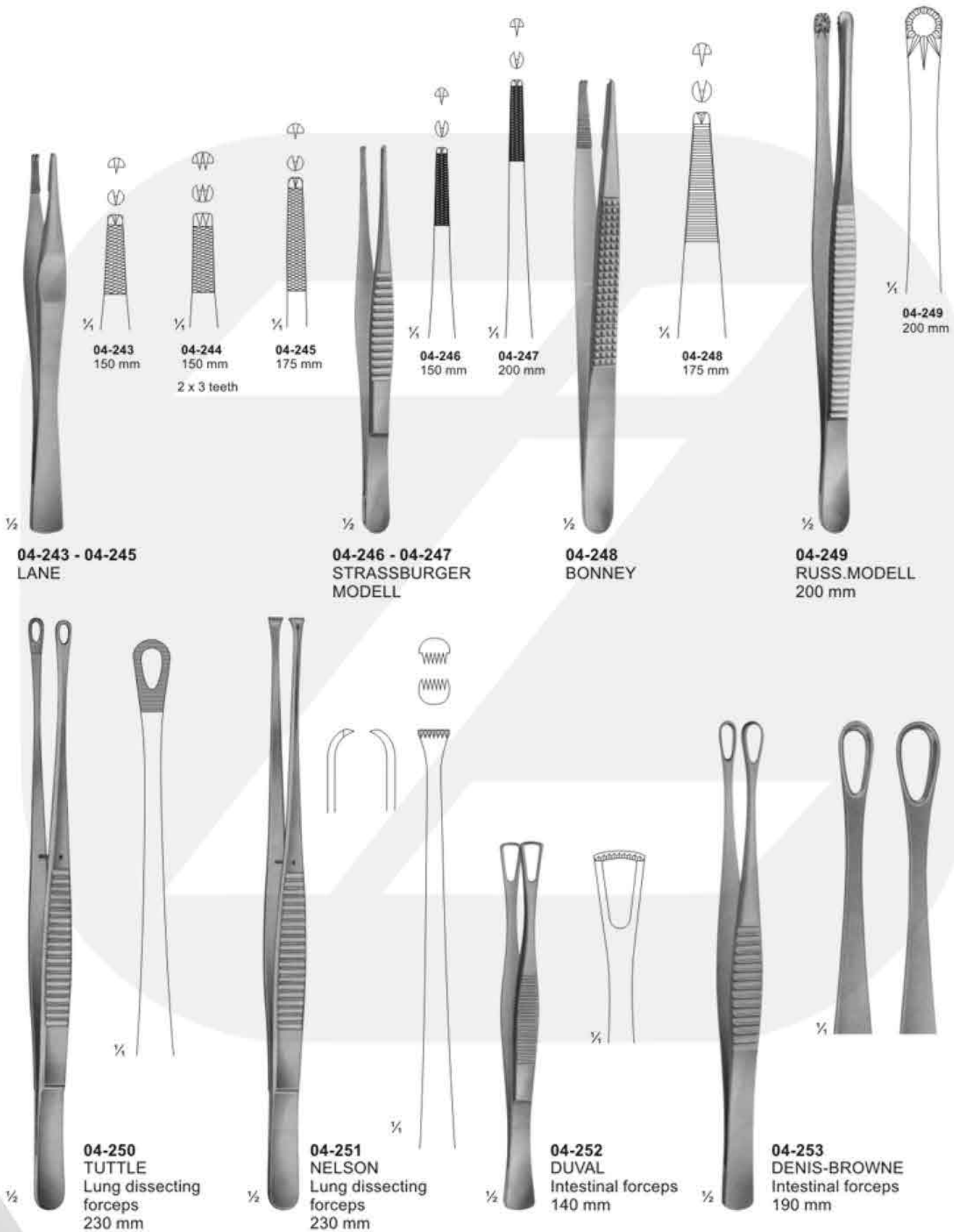



## Splinter and Cilia Forceps

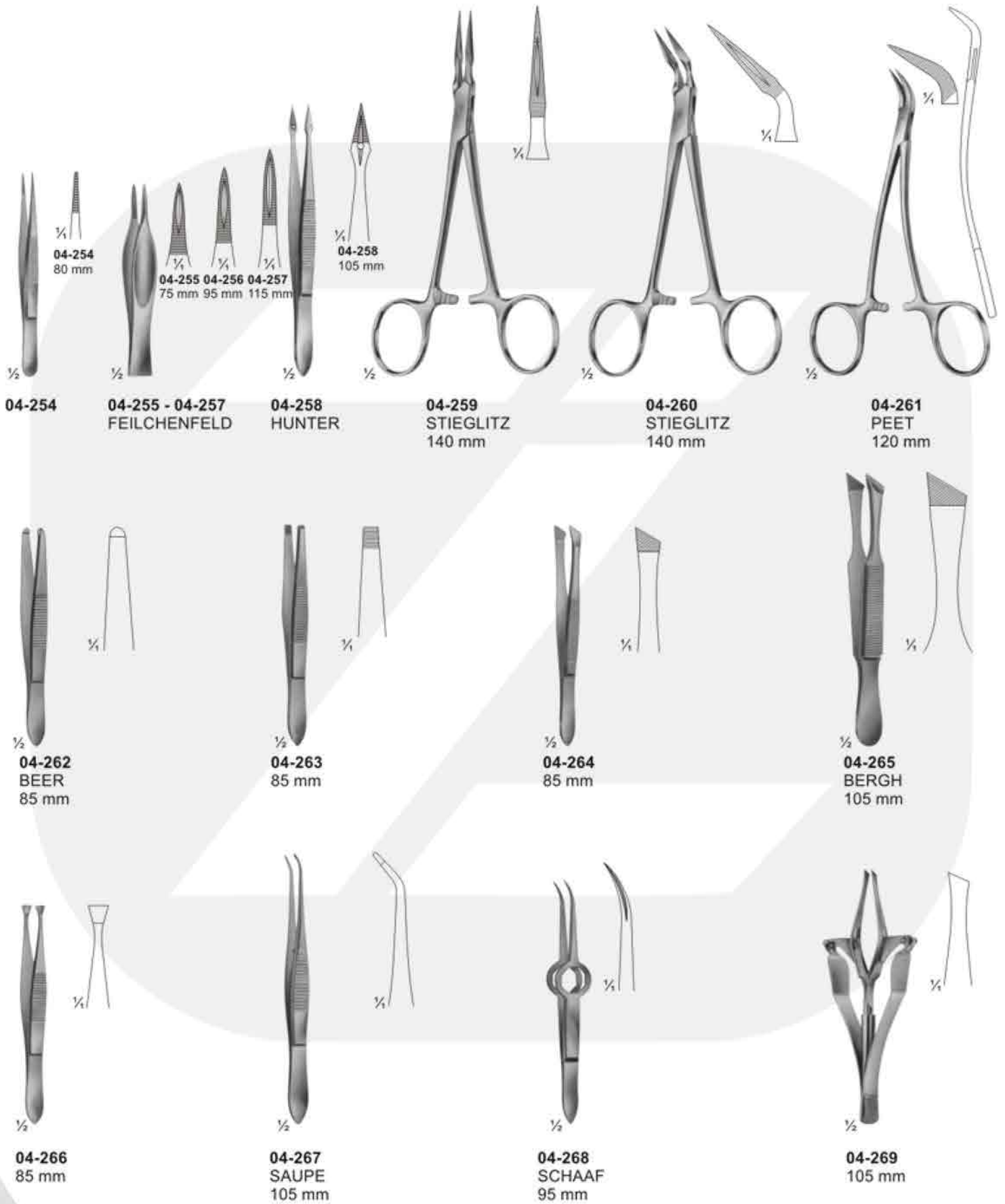

## Sponge and Dressing Forceps

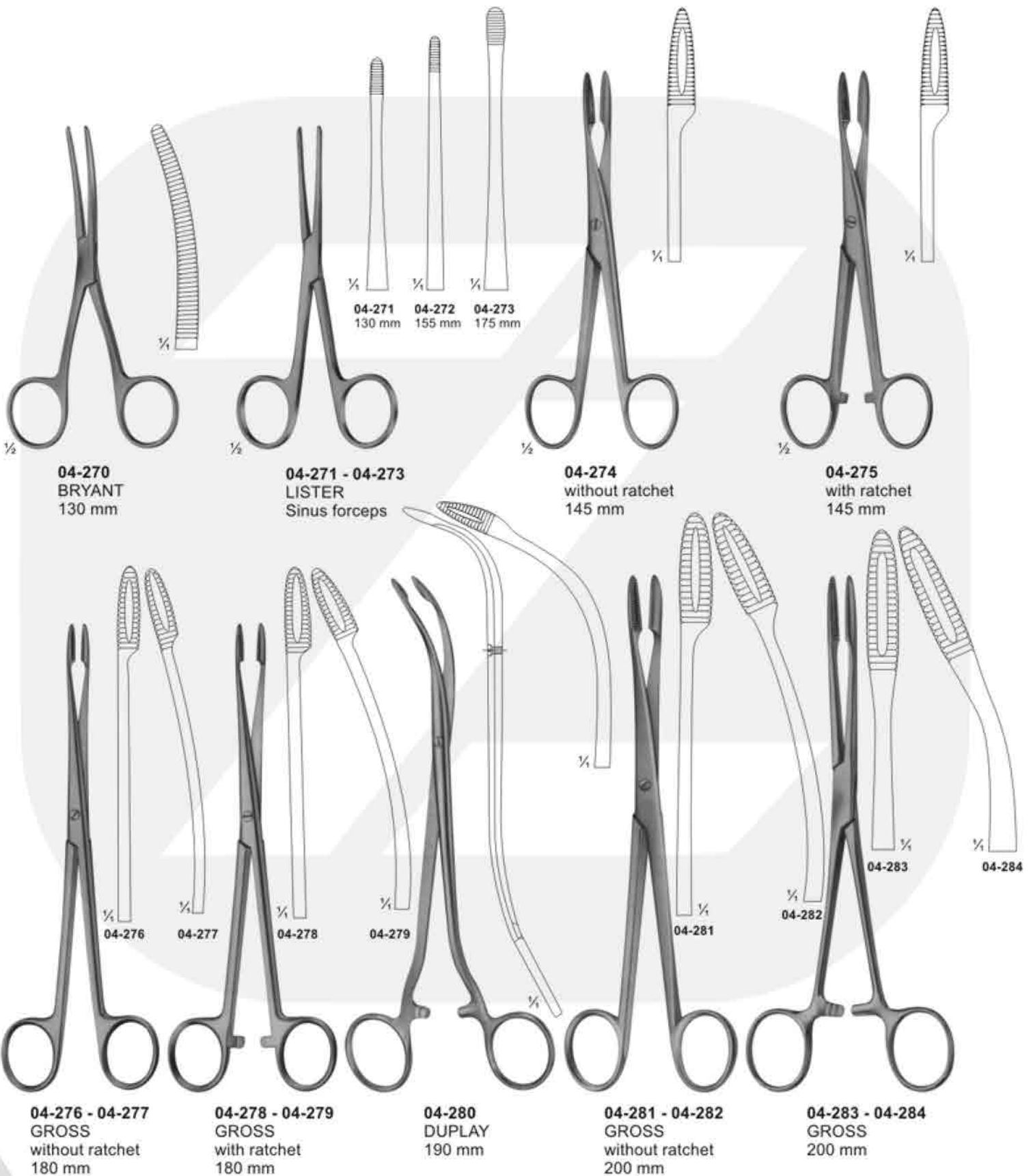

**Dressing-, Sponge holding-, Organ- and Tissue Grasping Forceps**

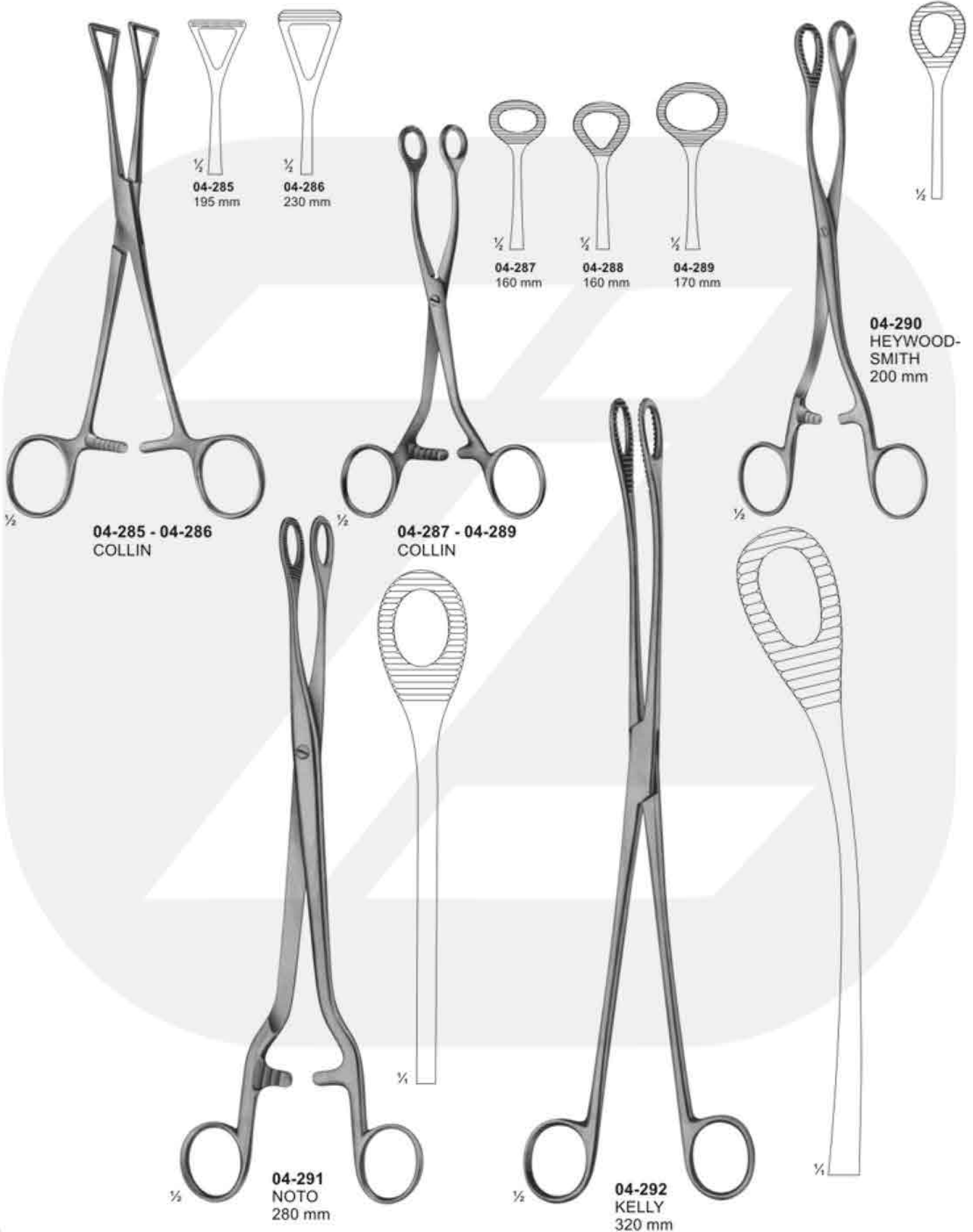

## Dressing, Sponge holding, Organ and Tissue Grasping Forceps

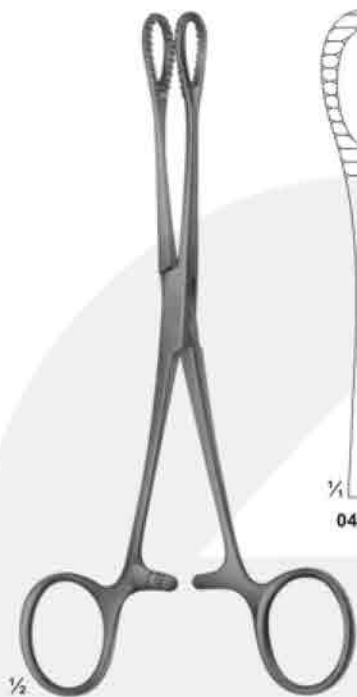

04-293



04-294

1/2  
**04-293 - 04-294**  
**FOERSTER-BALLENGER**  
180 mm



04-295  
180 mm



04-296  
250 mm

1/2  
**04-295 - 04-296**  
**RAMPLEY**



04-297  
Smooth Jaws



04-298  
Smooth Jaws



04-299  
Serrated Jaws



04-300  
Serrated Jaws



1/4

1/2  
**04-297 - 04-300**  
**FOERSTER-BALLENGER**  
240 mm

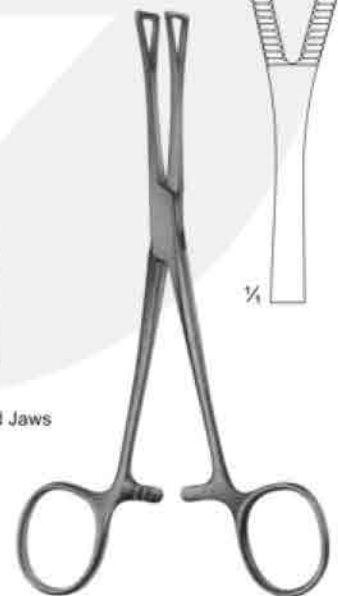

**04-301**  
**PENNINGTON**  
155 mm



## Intestinal Grasping Forceps

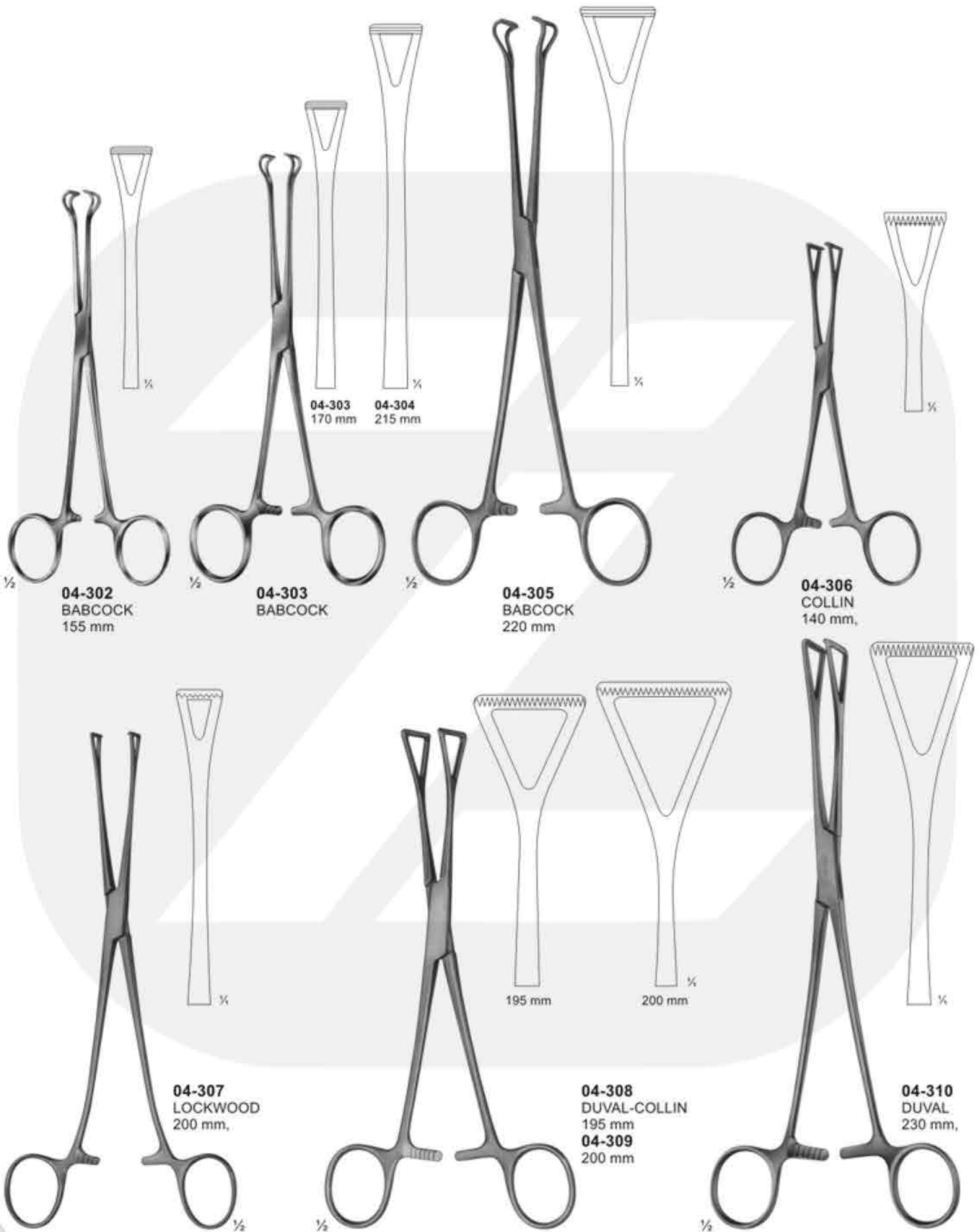

## Artery Traction - and Tissue Grasping Forceps

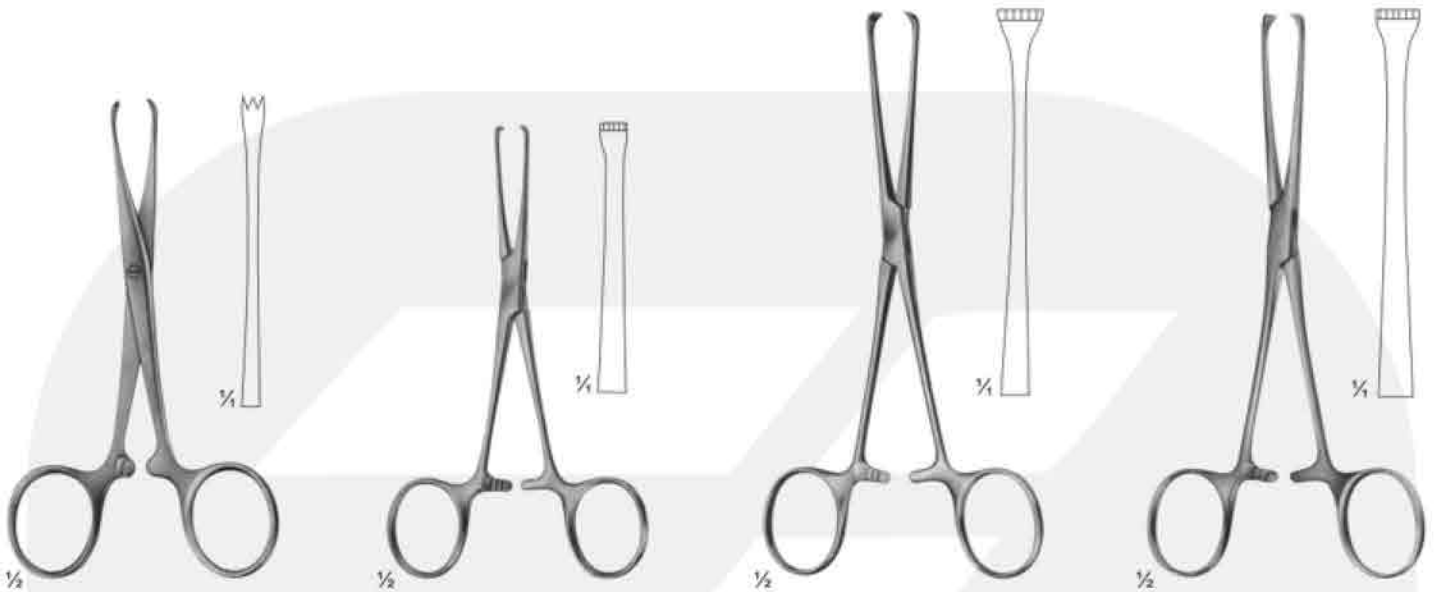

**04-311**  
**CHAPUT**  
 2 x 3 teeth  
 125 mm

**04-312**  
**BABY-ALLIS**  
 4 x 5 teeth  
 130 mm

**04-313**  
**BOYS-ALLIS**  
 5 x 6 teeth sharp  
 155 mm

**04-314**  
**ALLIS**  
 5 x 6 teeth  
 155 mm



**04-315**  
**LAHEY**  
 155 mm

**04-316**  
**LAHEY**  
 155 mm

**04-317**  
**BRAUN**  
 155 mm

**04-318**  
**MUSEUX**  
 200 mm

# Towel Clamps

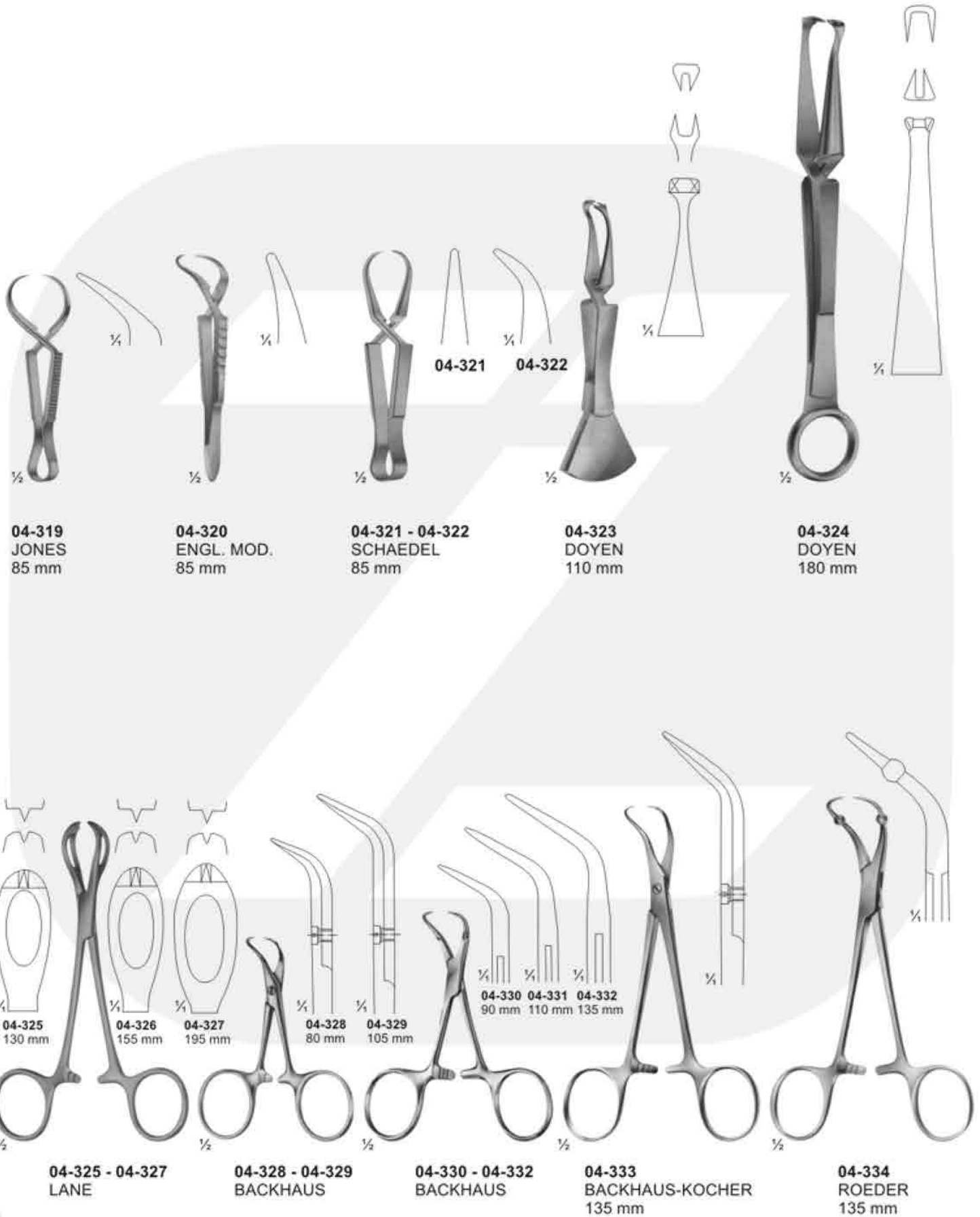

**04-319**  
JONES  
85 mm

**04-320**  
ENGL. MOD.  
85 mm

**04-321 - 04-322**  
SCHAEDEL  
85 mm

**04-323**  
DOYEN  
110 mm

**04-324**  
DOYEN  
180 mm

**04-325**  
130 mm

**04-326**  
155 mm

**04-327**  
195 mm

**04-328**  
80 mm

**04-329**  
105 mm

**04-330 04-331 04-332**  
90 mm 110 mm 135 mm

**04-325 - 04-327**  
LANE

**04-328 - 04-329**  
BACKHAUS

**04-330 - 04-332**  
BACKHAUS

**04-333**  
BACKHAUS-KOCHER  
135 mm

**04-334**  
ROEDER  
135 mm



# Muller Vessel Clips and Bulldog Clamps

## Closing force

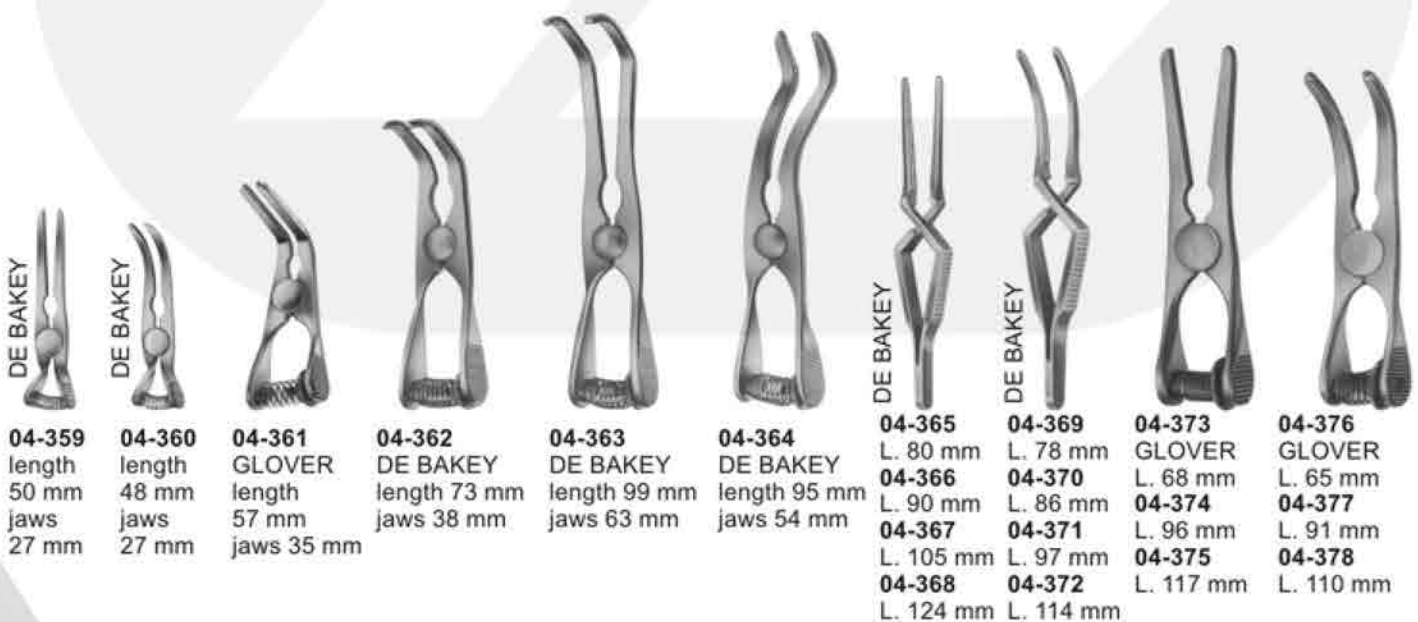
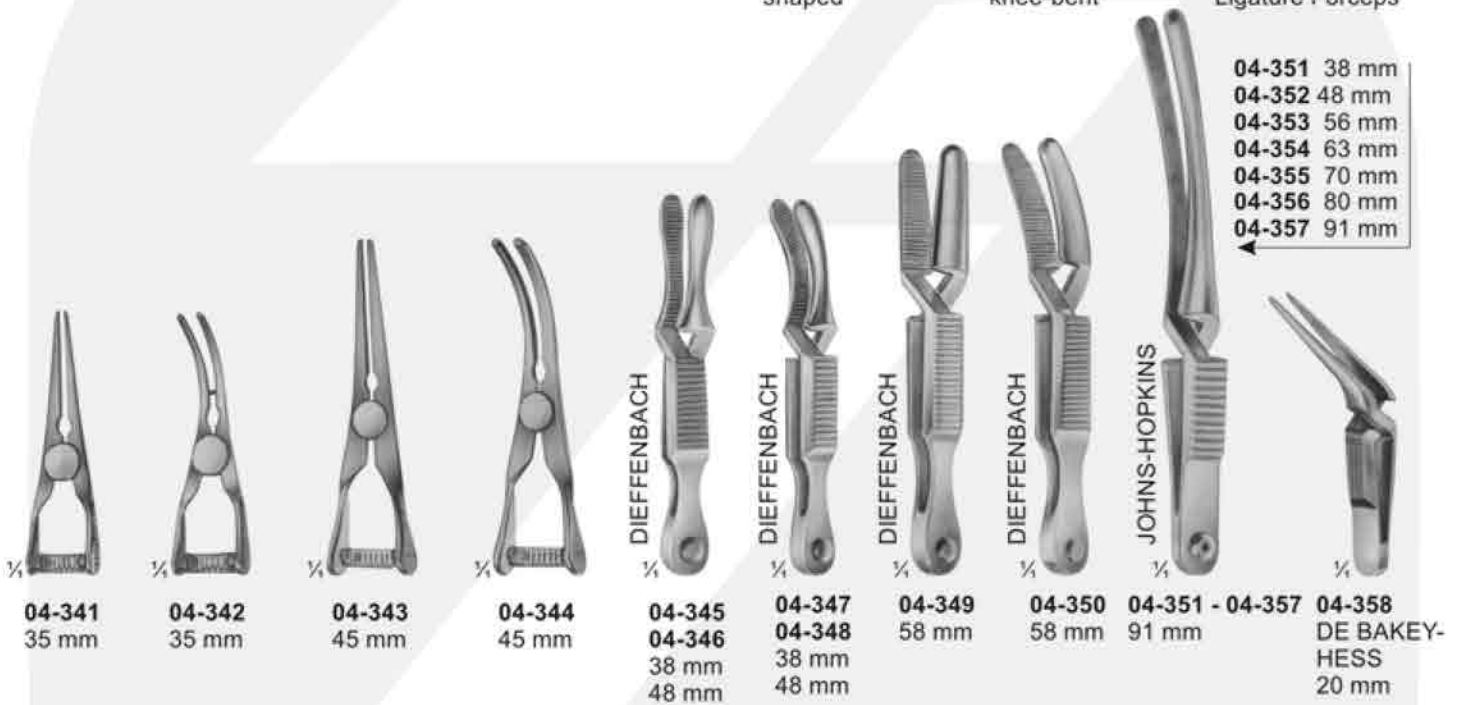
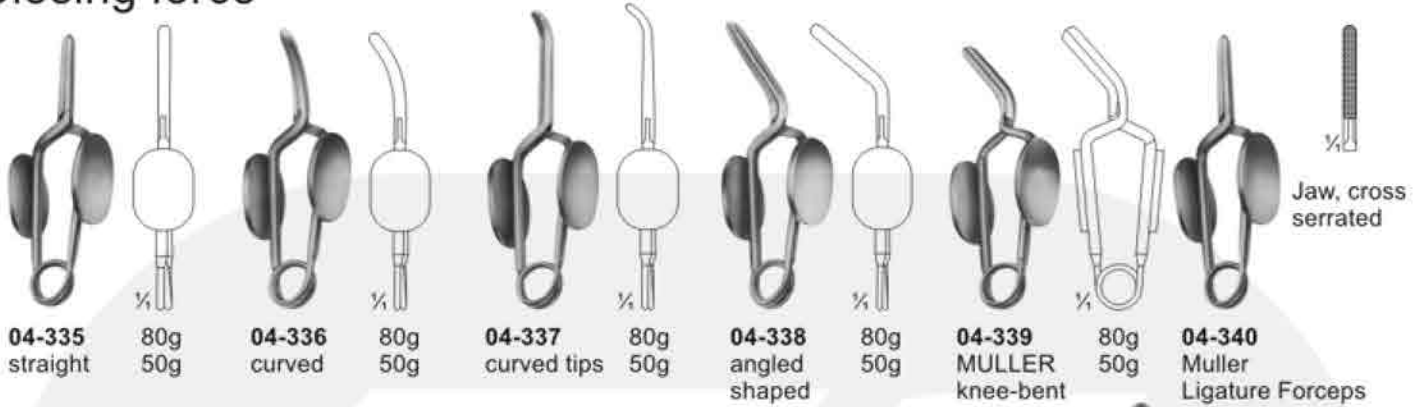



## Delicate Haemostatic Forceps

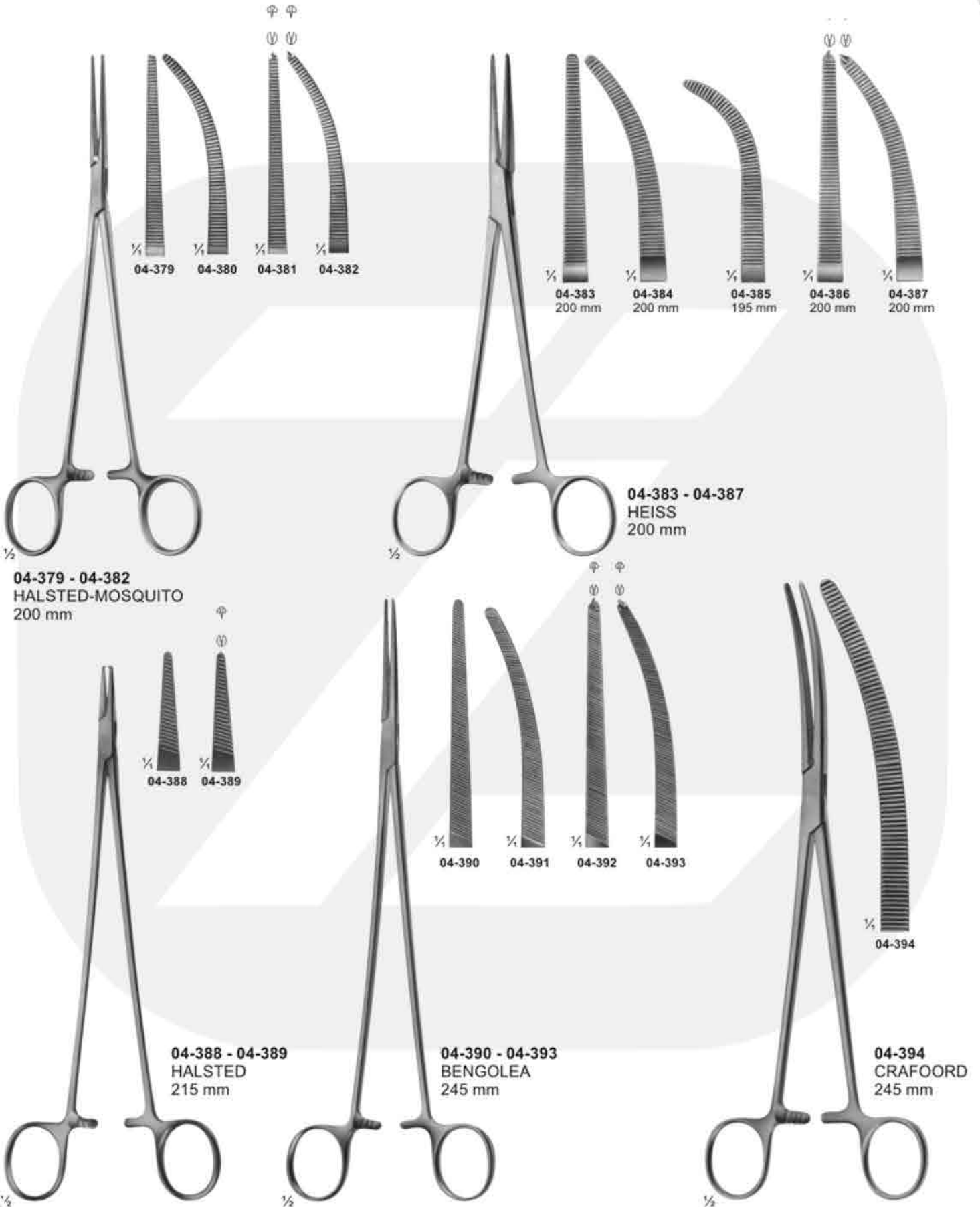

## Delicate Haemostatic Forceps



## Delicate Haemostatic Forceps

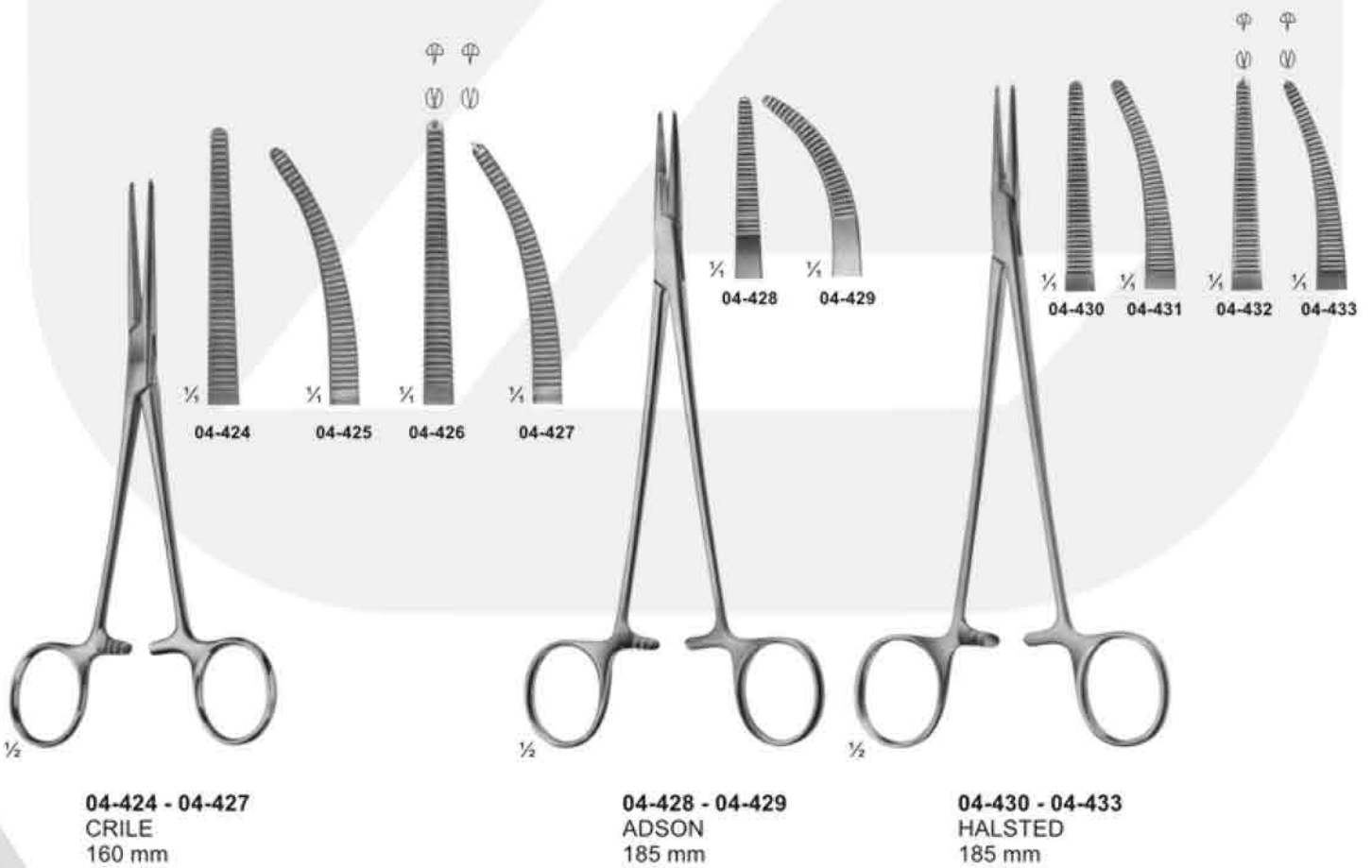
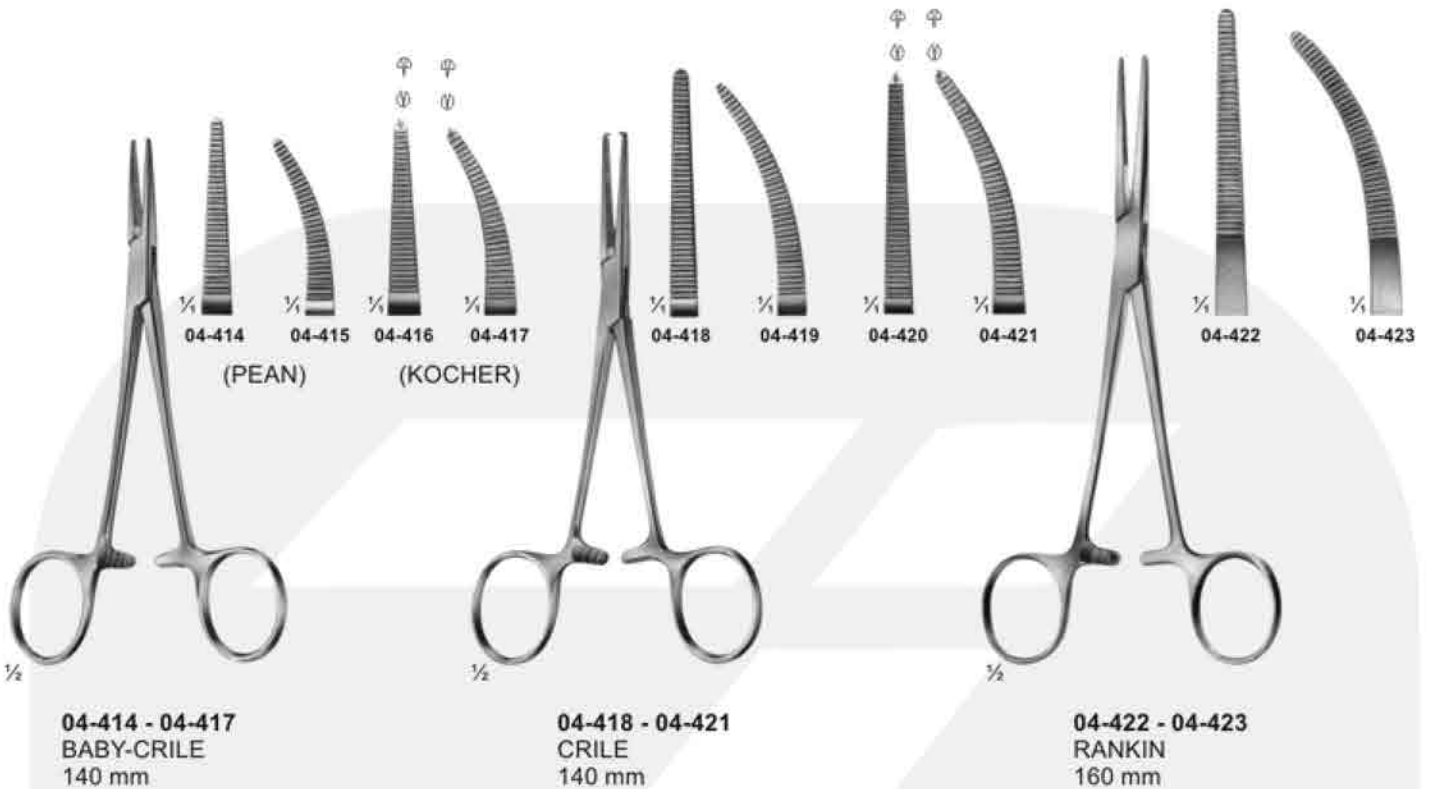

# Haemostatic Forceps



**04-434 - 04-437**  
PEAN  
Slender type

**04-438 - 04-445**  
SPENCER-WELLS  
Slender type

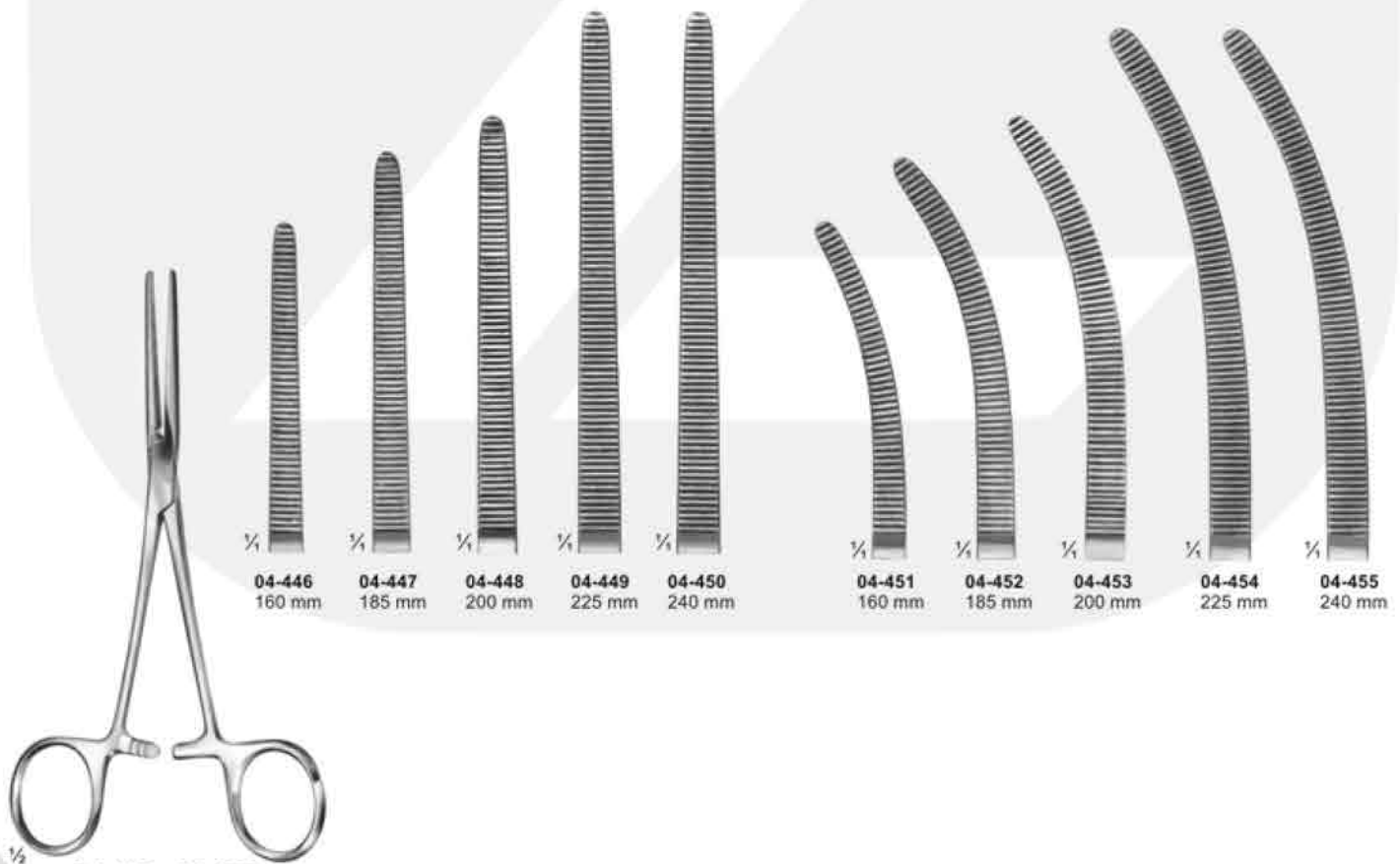

**04-446 - 04-455**  
ROCHESTER-PEAN



# Haemostatic Forceps

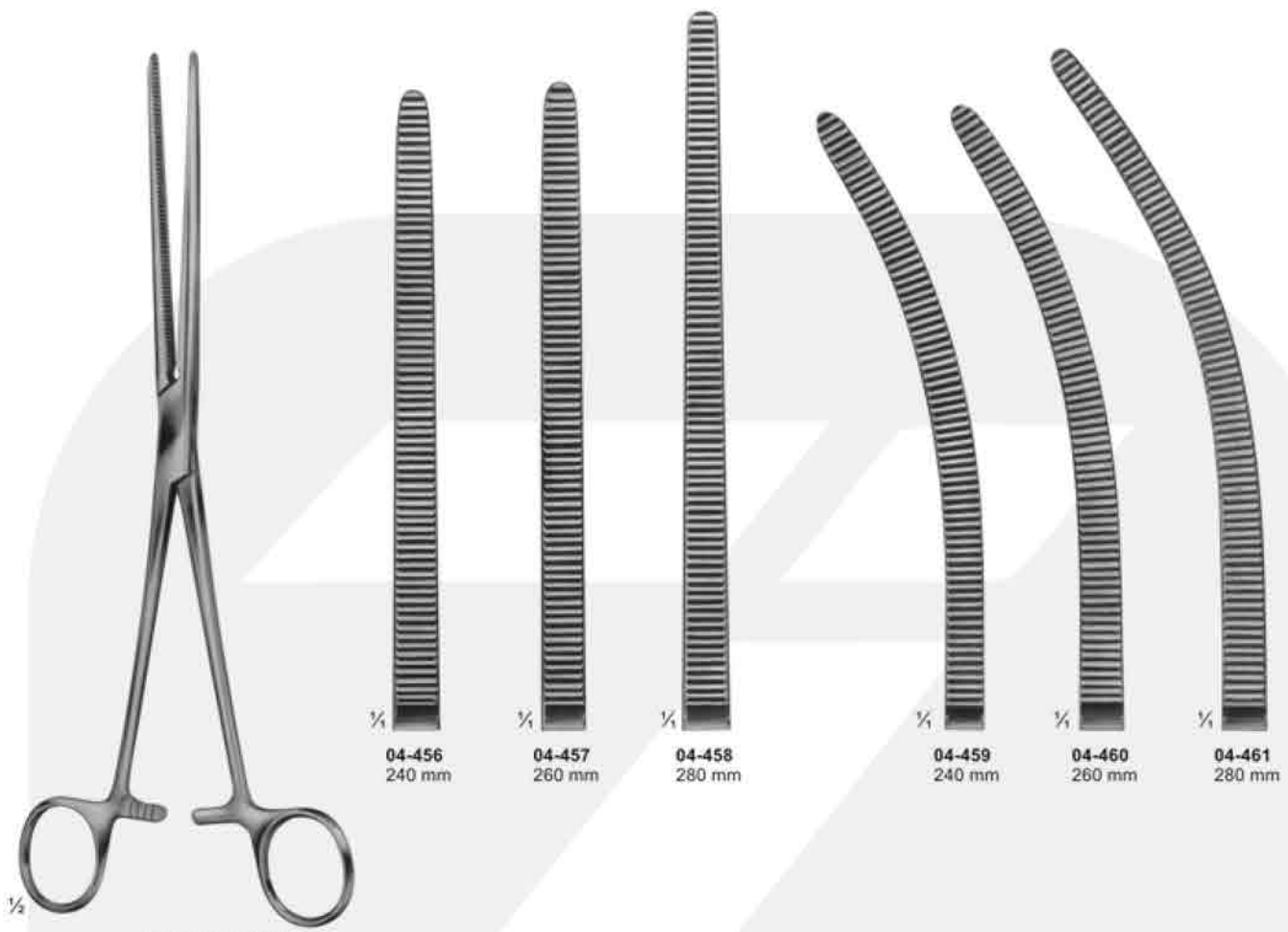

**04-456 - 04-461**  
PEAN

- ¼

**04-456**  
240 mm
- ¼

**04-457**  
260 mm
- ¼

**04-458**  
280 mm
- ¼

**04-459**  
240 mm
- ¼

**04-460**  
260 mm
- ¼

**04-461**  
280 mm

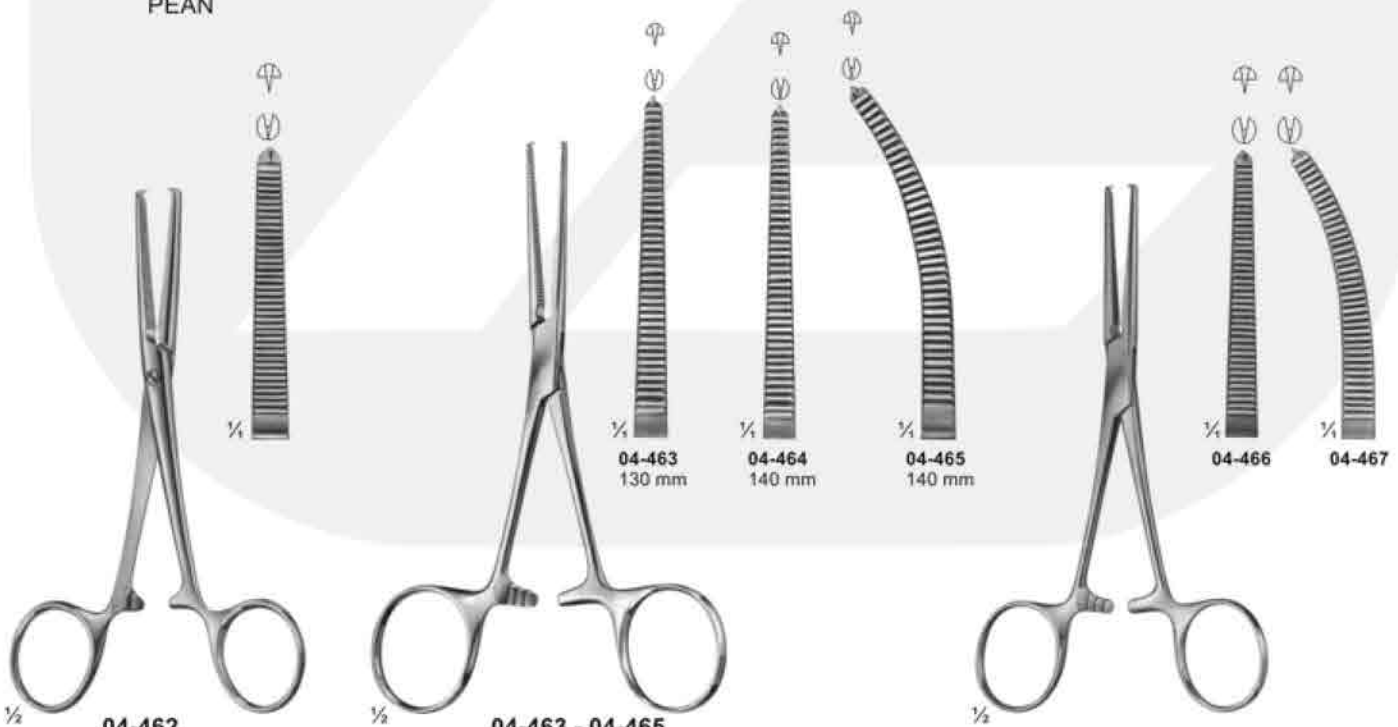

**04-462**  
KOCHER  
Strong Pattern  
145 mm

**04-463 - 04-465**  
KOCHER

**04-466 - 04-467**  
ROCHESTER-OSHSNER  
140 mm

- ¼

**04-463**  
130 mm
- ¼

**04-464**  
140 mm
- ¼

**04-465**  
140 mm
- ¼

**04-466**
- ¼

**04-467**

# Haemostatic Forceps

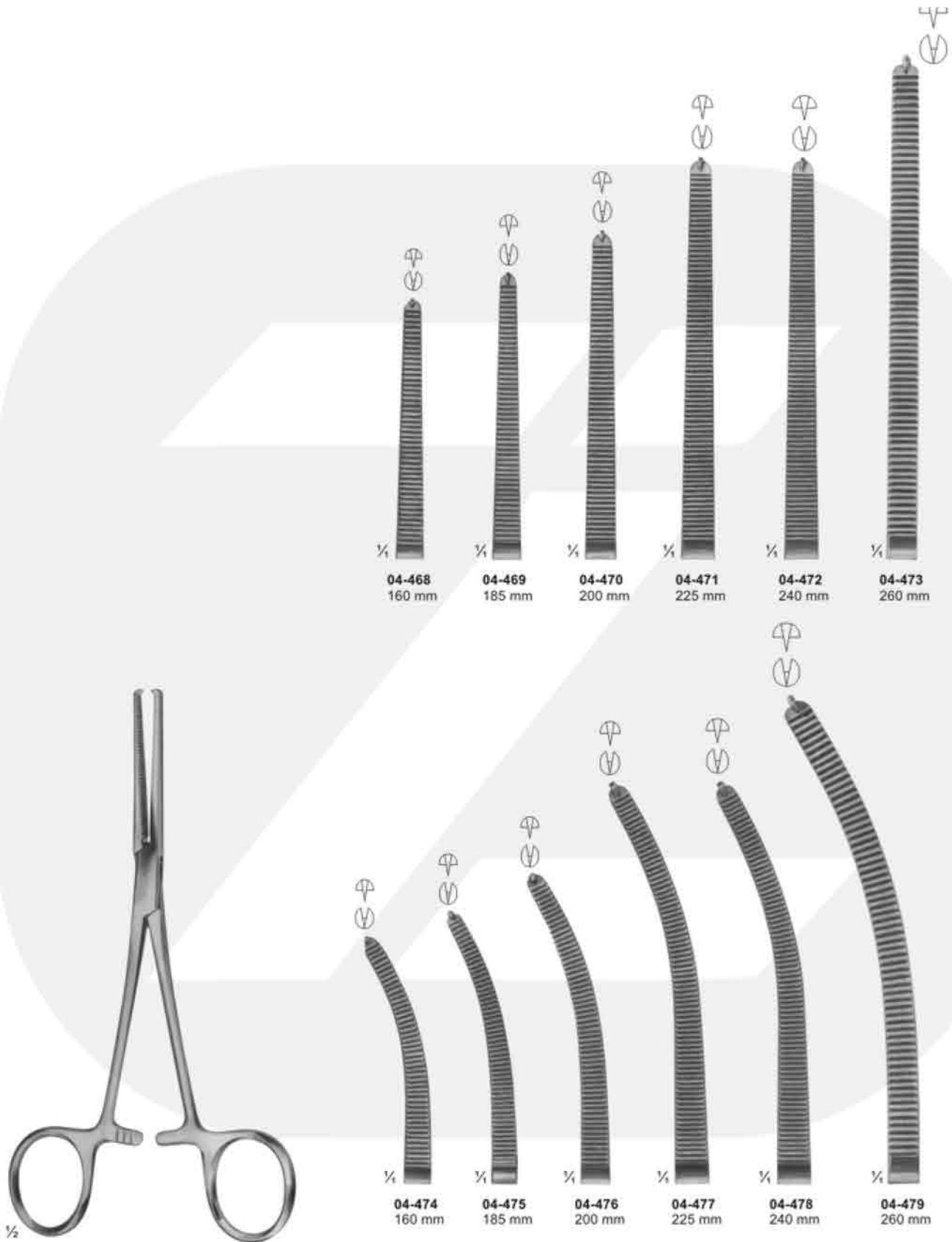

$\frac{1}{4}$  **04-468** 160 mm  
 $\frac{1}{4}$  **04-469** 185 mm  
 $\frac{1}{4}$  **04-470** 200 mm  
 $\frac{1}{4}$  **04-471** 225 mm  
 $\frac{1}{4}$  **04-472** 240 mm  
 $\frac{1}{4}$  **04-473** 260 mm

$\frac{1}{4}$  **04-474** 160 mm  
 $\frac{1}{4}$  **04-475** 185 mm  
 $\frac{1}{4}$  **04-476** 200 mm  
 $\frac{1}{4}$  **04-477** 225 mm  
 $\frac{1}{4}$  **04-478** 240 mm  
 $\frac{1}{4}$  **04-479** 260 mm

**04-468 - 04-479**  
KOCHER-OCHSNER

## Haemostatic Forceps

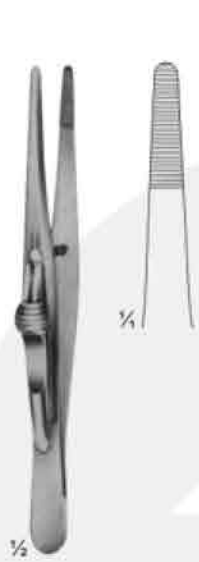

**04-480**  
**FRICKE**  
Artery forceps  
130 mm

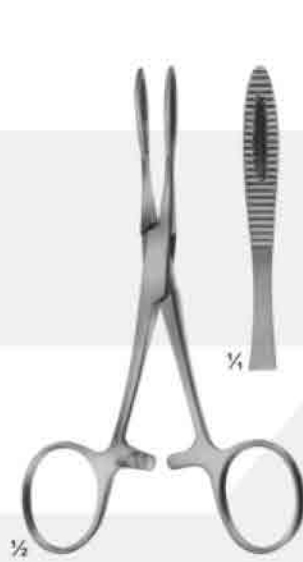

**04-481**  
**KRONLEIN**  
130 mm



**04-482**  
**PEAN**  
125 mm

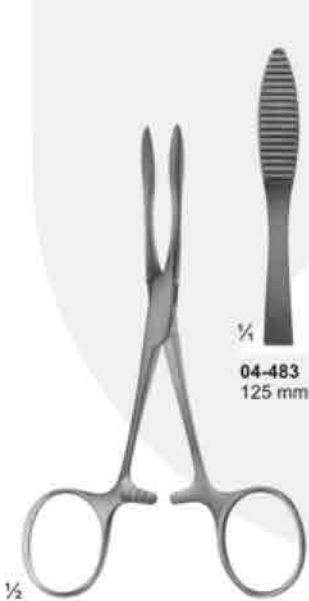

**04-483**  
125 mm



**04-484**  
140 mm

**04-483 - 04-484**  
**PEAN**



**04-485**  
**PEAN**  
125 mm

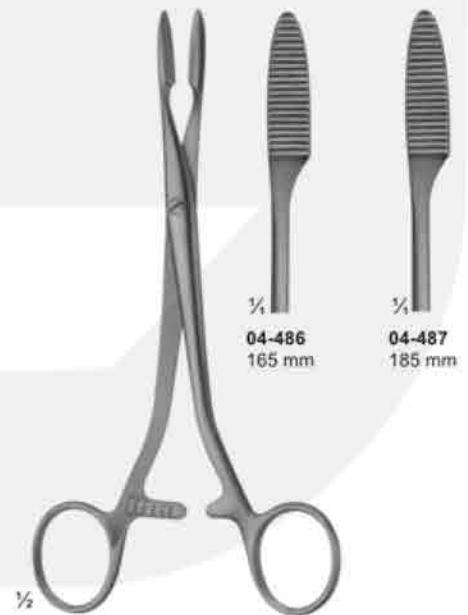

**04-486**  
165 mm

**04-487**  
185 mm

**04-486 - 04-487**  
**PEAN**

## Haemostatic Forceps, Special Pattern, Tonsil Forceps

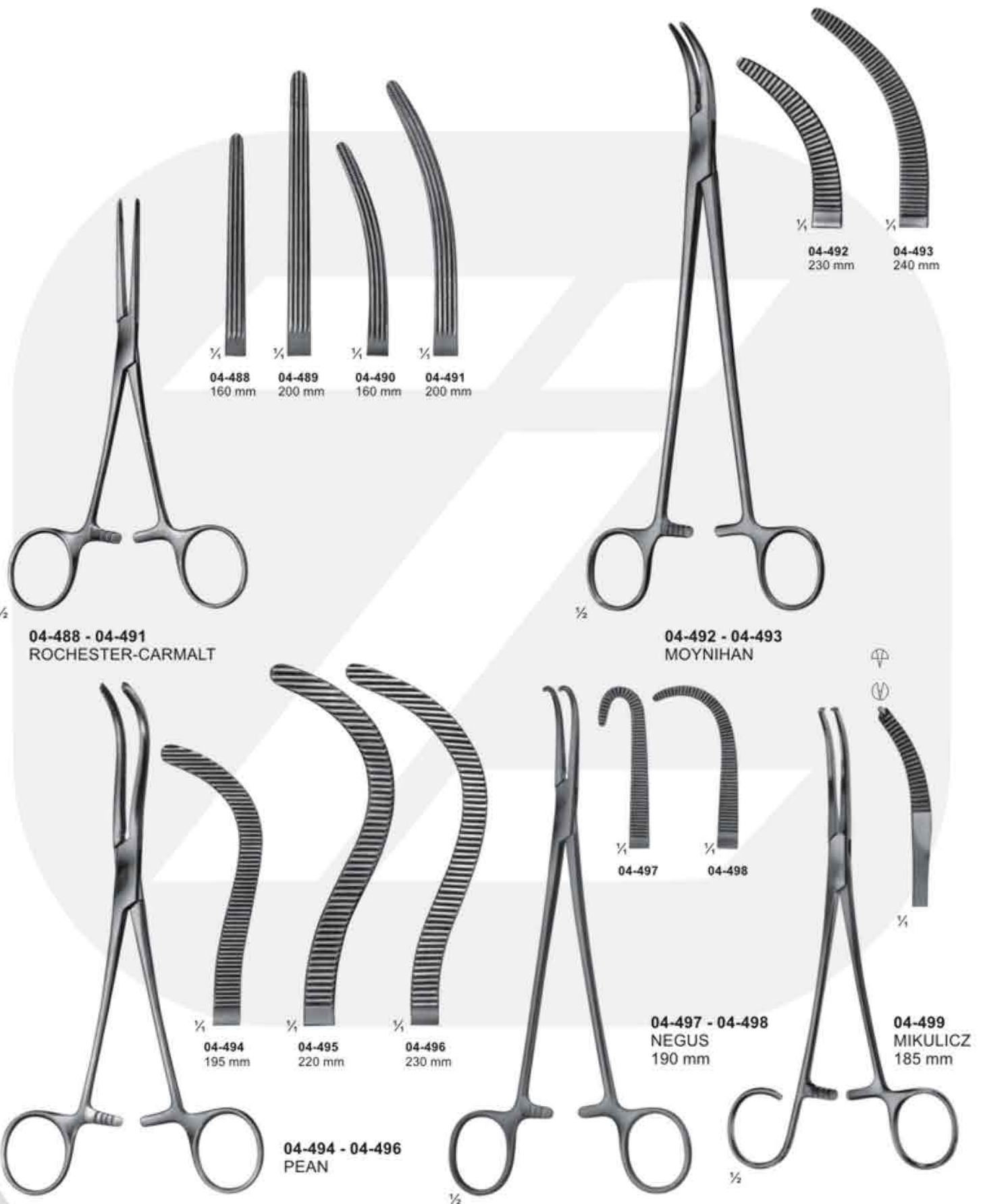



## Dissecting- and Ligature Forceps

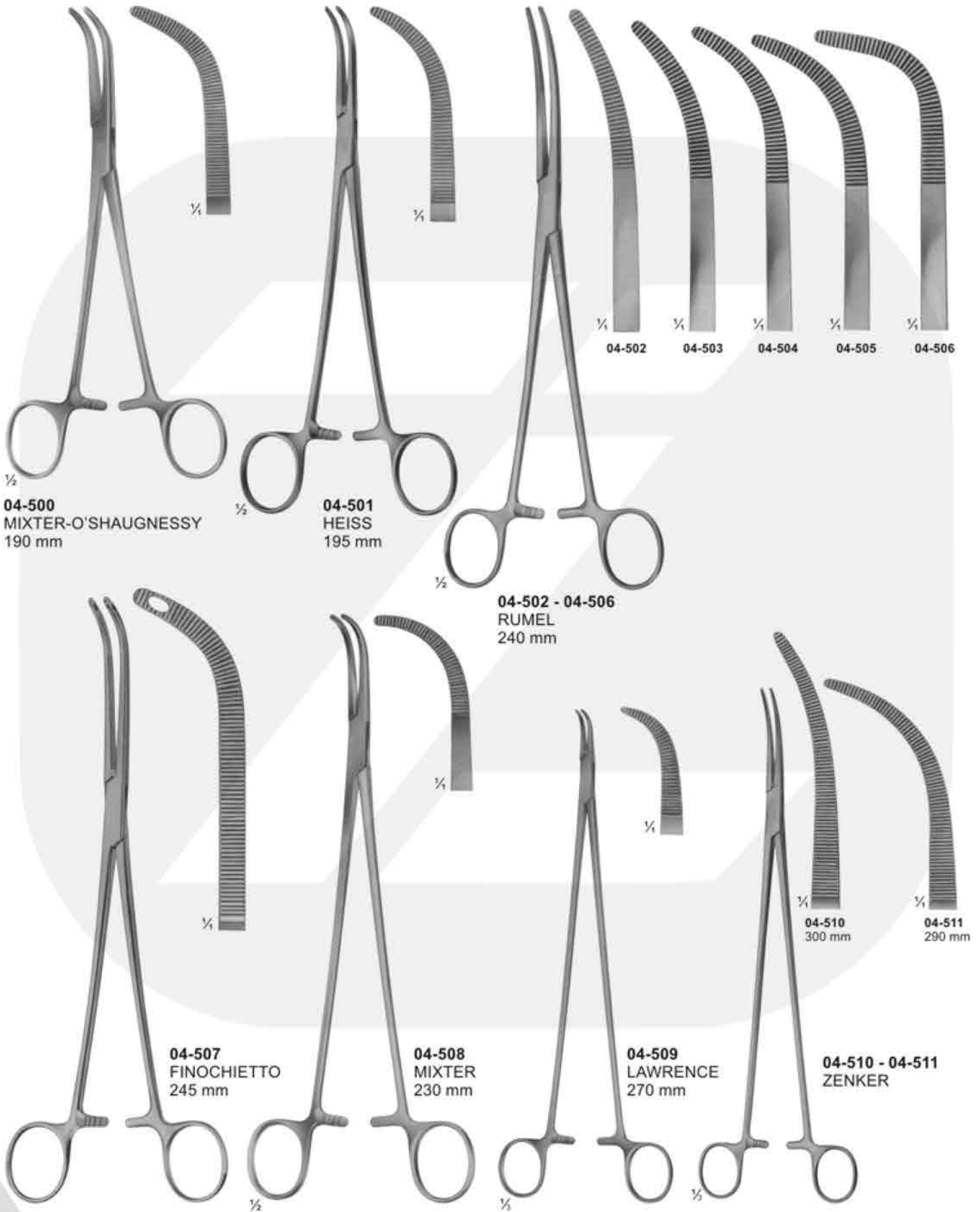

**Hysterectomy Forceps, Vaginal Clamps  
and Compression Forceps**

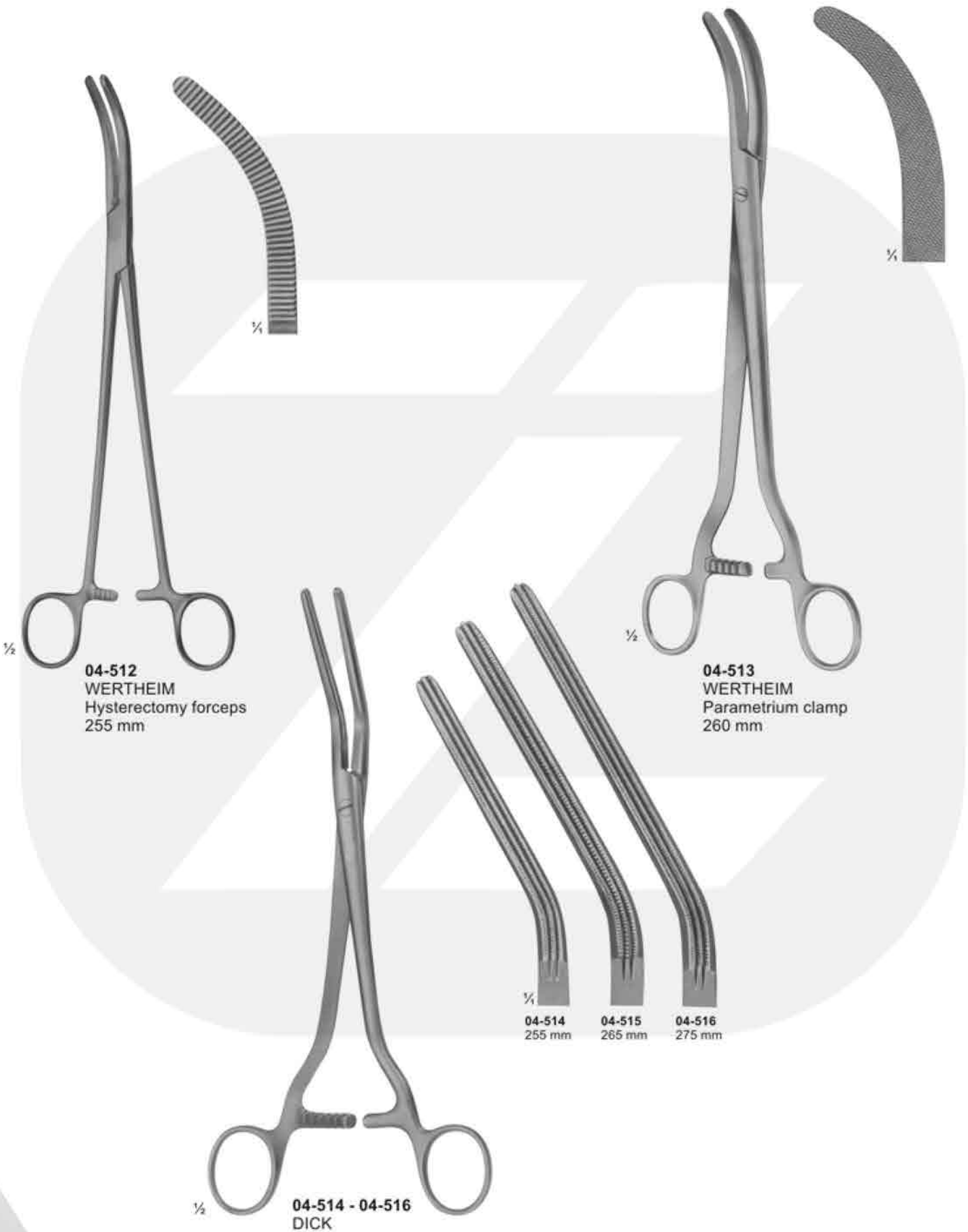

# Hysterectomy Forceps, Vaginal Clamps and Compression Forceps

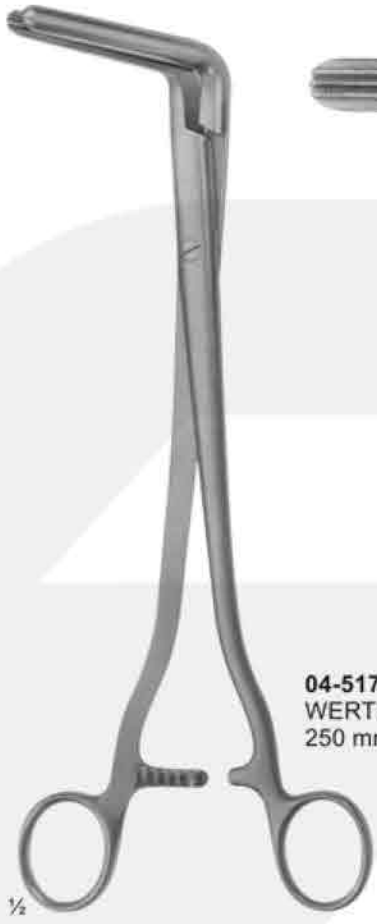

**04-517**  
WERTHEIM  
250 mm



**04-518**  
WERTHEIM-CULLEN  
215 mm

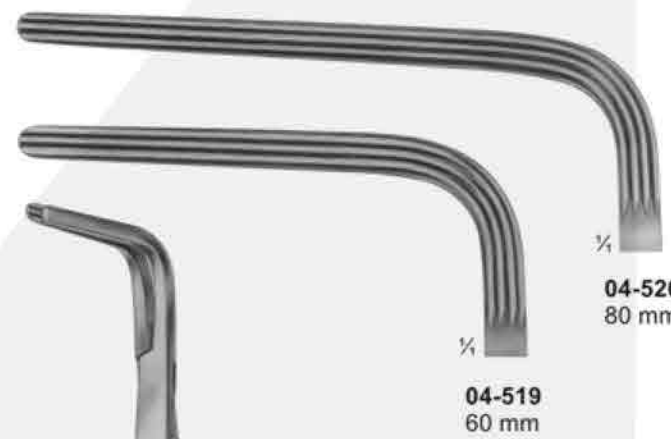

**04-519**  
60 mm



**04-519 - 04-520**  
230 mm

**04-520**  
80 mm

# Needle Holders for micro surgery

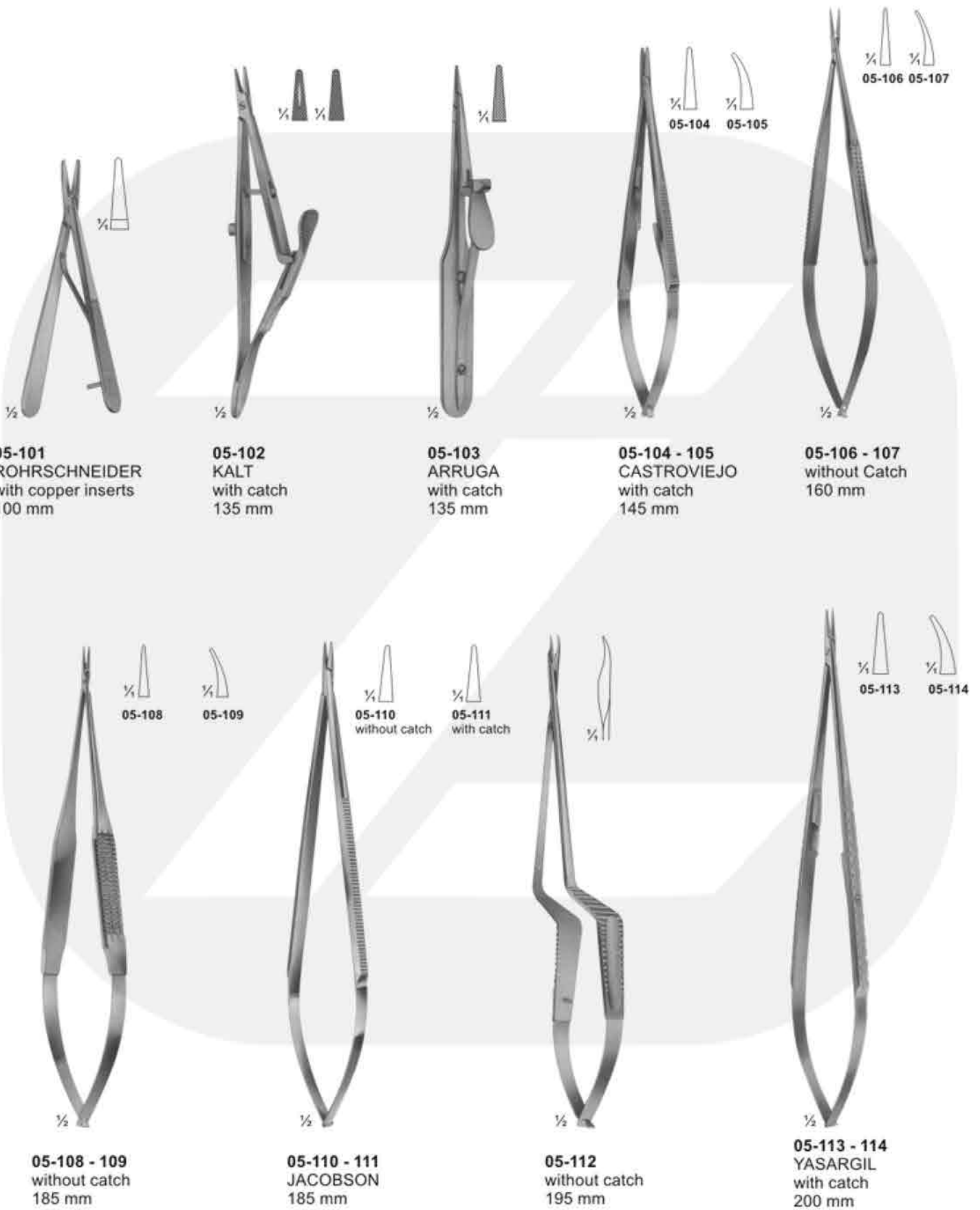

**05-101**  
ROHRSCHEIDER  
with copper inserts  
100 mm

**05-102**  
KALT  
with catch  
135 mm

**05-103**  
ARRUGA  
with catch  
135 mm

**05-104 - 105**  
CASTROVIEJO  
with catch  
145 mm

**05-106 - 107**  
without Catch  
160 mm

**05-108 - 109**  
without catch  
185 mm

**05-110 - 111**  
JACOBSON  
185 mm

**05-112**  
without catch  
195 mm

**05-113 - 114**  
YASARGIL  
with catch  
200 mm



# Needle Holders

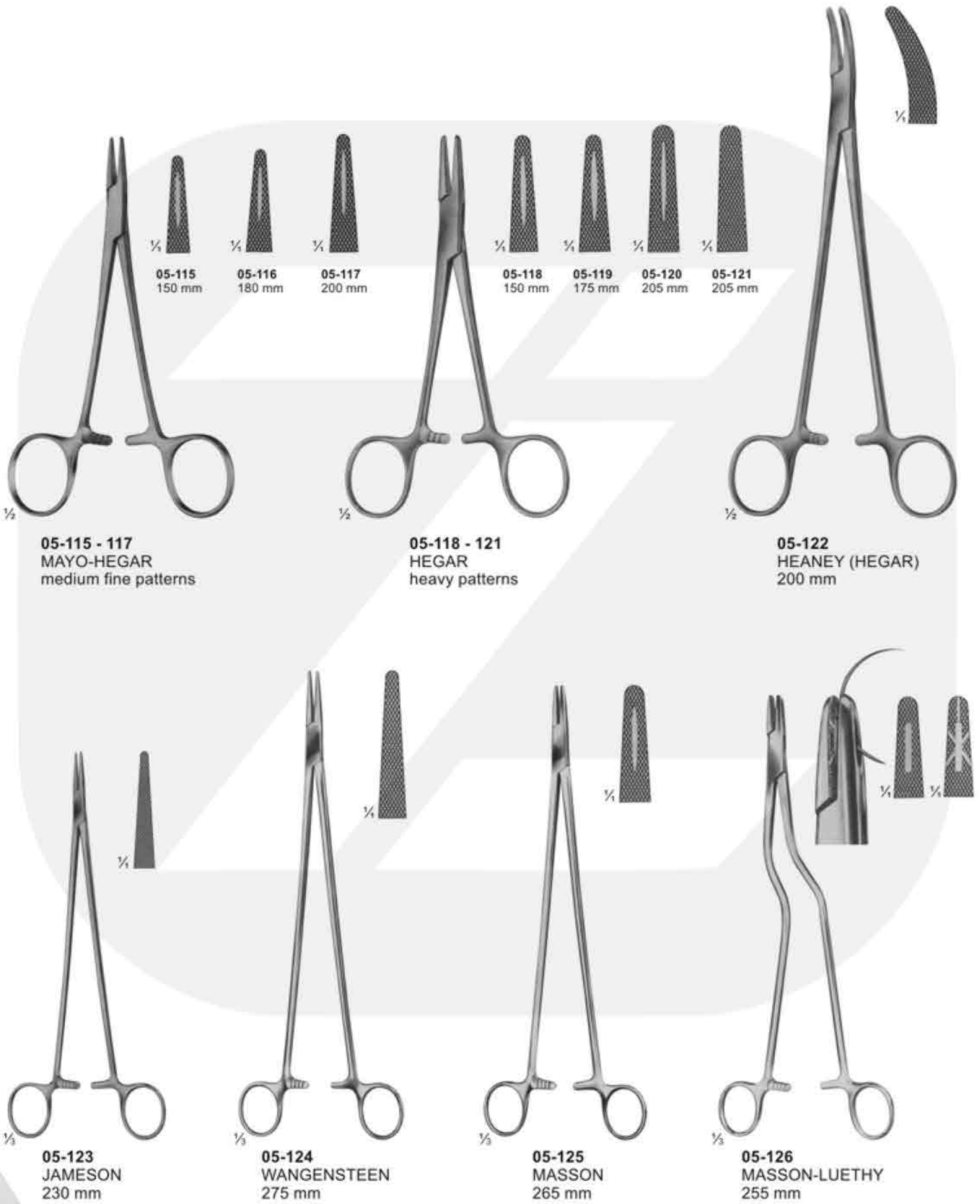

## Needle Holders

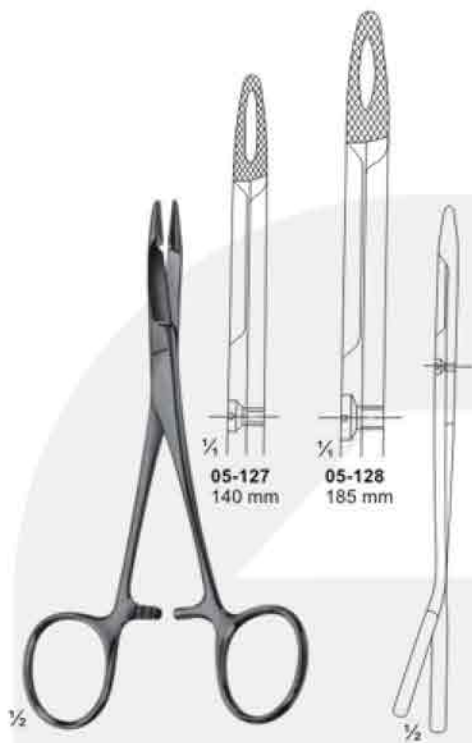

**05-127 - 128**  
**HEGAR-OLSEN**  
255 mm



**05-129**  
**GILLIES**  
150 mm



**05-130**  
**GILLIES**  
160 mm



**05-131**  
**EISELSBERG**  
115 mm



**05-132**  
**SCHOEMAKER-LOTH**  
125 mm



**05-133**  
**CRILE**  
150 mm



**05-134**  
**TOENNIS**  
Elastic pattern for dura-or  
intestinal suture. 180 mm

# Needle Holders

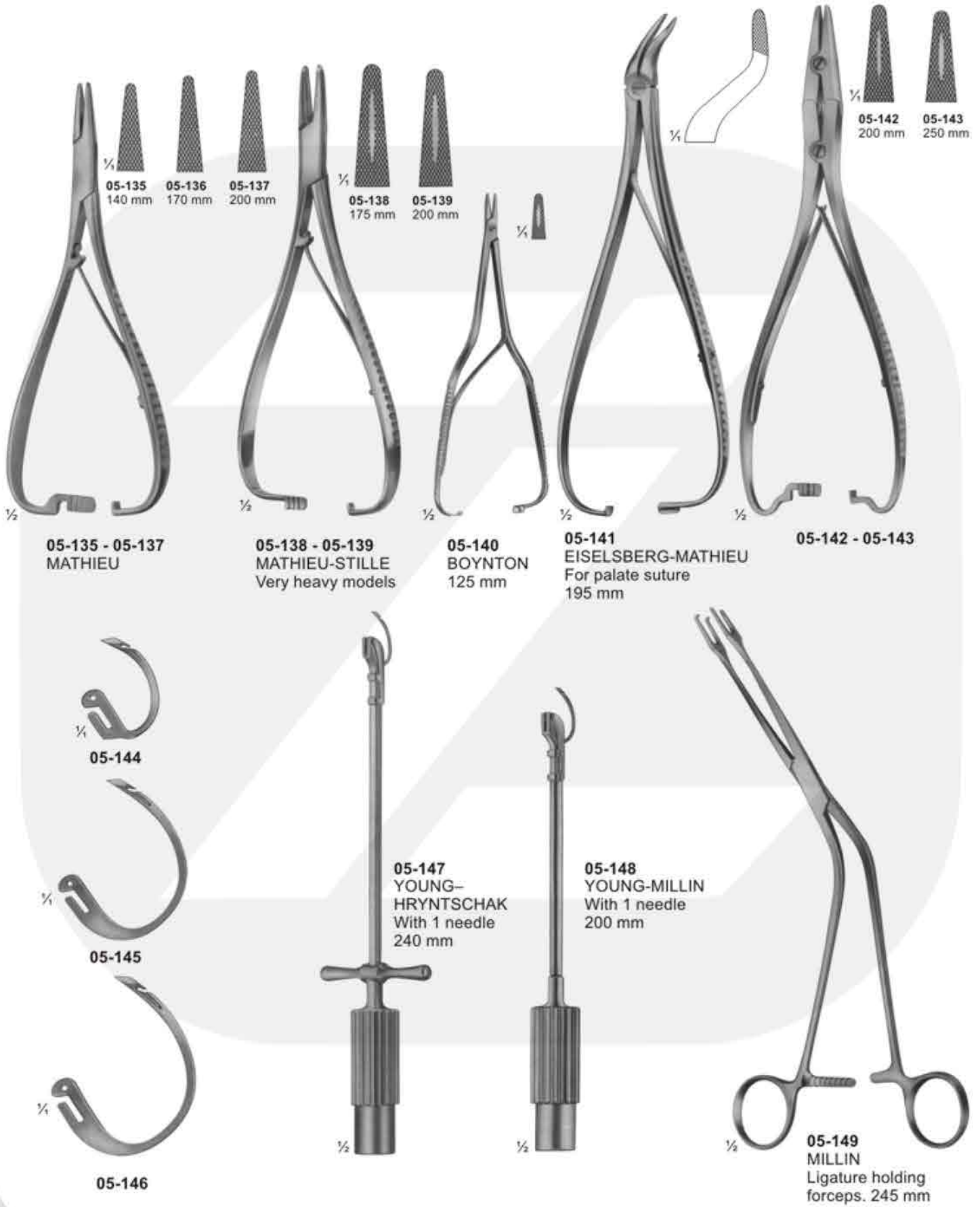

## Suture Instruments - Reverdin Needles

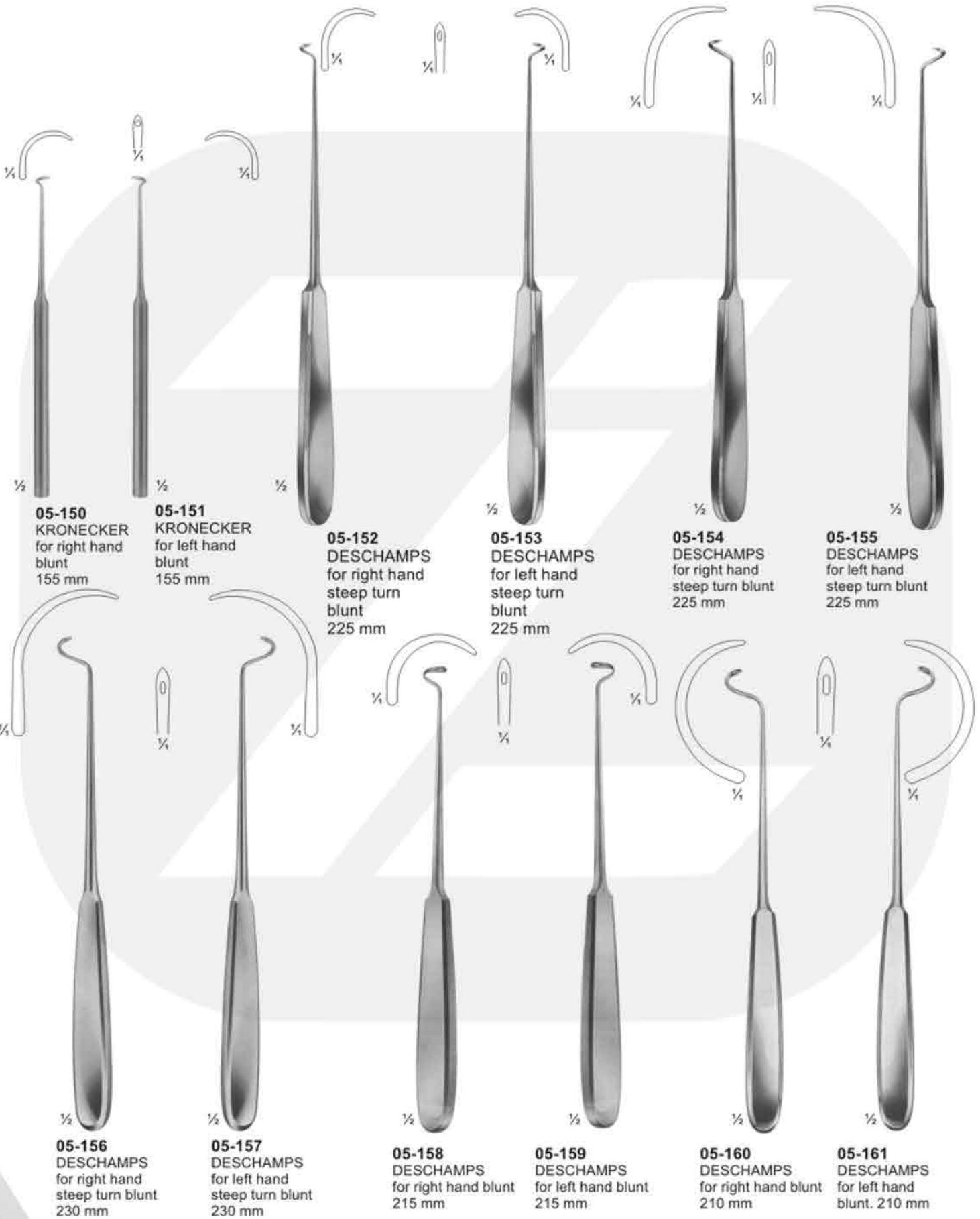



# Probes



05-162 130 mm  
05-163 145 mm  
05-164 160 mm  
Directors

05-165  
DOYEN  
145 mm  
Directors

05-166  
NELATON  
160 mm  
Directors

05-167  
Director with tip  
Diam. Of tip 3,3 mm  
140 mm

05-168  
BRODIE  
Director with tip,  
Diam. Of tip 3,5 mm  
200 mm

Nr. 1

Nr. 2

Nr. 3

Nr. 4

05-169  
LOCKHART-MUMMERY  
165 mm

05-170  
LOCKHART-MUMMERY  
165 mm

05-171  
LOCKHART-MUMMERY  
165 mm

05-172  
LOCKHART-MUMMERY  
165 mm

05-173  
Director with wire  
loop, malleable  
190 mm

# Probes

05-174  
2,5 mm  
05-175  
2,5 mm  
05-176  
3,0 mm



05-174 145 mm  
05-175 160 mm  
05-176 200 mm  
Probes with eye

1,5 mm



05-177  
Myrtle leaf probe  
145 mm

2,0 mm



05-178 130 mm  
05-179 145 mm  
05-180 160 mm  
05-181 180 mm  
05-182 200 mm

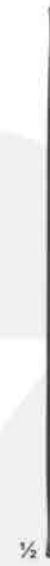

05-183  
Probes



05-184  
Double ended probe,  
malleable, diam. of tips  
3 mm with hole  
30 mm



05-185  
Double ended probes,  
tin, malleable,  
diam. of tips  
3,5 mm with hole  
250 mm, 300 mm



05-186  
Double ended probes,  
tin, malleable,  
diam. of tips 4 mm  
400 mm



05-187 1,5 mm  
05-188 2,0 mm  
05-189 2,5 mm  
300 mm

## Suturing Instrument Set, Pocket Instrument Set



### 05-190

Suturing instruments set, in metal case consisting of: Scissors, curved, sharp/sharp, 115mm  
25 MICHEL clip, 16 x 3mm  
1 Delicate tissue forceps, 130mm  
1 Scalpel, bellied  
1 MATHIEU needle holder, 140mm  
1 Perforated metal case, stainless containing:  
1 Suture needle  
1 item 1 item



### 05-191

Pocket instrument set, in metal case consisting of:

#### Bottom tray

1 MATHIEU needle holder, 140mm  
1 MICHEL clip forceps, combined  
1 Myrtle leaf probe, 130mm  
1 Sharp double curette  
1 Skin hook  
1 Detachable scalpel handle, no.4  
1 Perforated metal case, containing  
6 Scalpel blades  
1 Perforated metal case, stainless, containing  
1 Suture needle  
1 item  
1 item

#### Top tray

1 Tissue forceps, 130mm  
1 KOCHER haemostatic forceps, 130mm  
1 Straight surgical scissors, 130mm  
1 Dissecting forceps, 130mm  
1 FEILCHENFELD splinter forceps, 115mm  
25 MICHEL clip, 16 x 3mm  
1 Flacon of suture skin, sterile in alcohol



### 05-192

Pocket instrument set, in metal case consisting of:

#### Bottom tray

1 MAYO-HÉGER needle holder, 150mm  
1 MICHEL clip forceps, combined  
1 Myrtle leaf probe, 130mm  
1 Sharp double curette  
1 Skin hook  
1 Detachable scalpel handle, no. 4  
1 Perforated metal case, consisting  
6 Scalpel blades  
1 Perforated metal case, stainless, consisting:  
1 Suture needle  
1 item, & 1 item

#### Top tray

1 Tissue forceps, 130mm  
1 CRILE haemostatic forceps, 140mm  
1 Straight surgical scissors, 130mm  
1 Dissecting forceps, 130mm  
1 FEILCHENFELD splinter forceps, 115mm  
25 MICHEL clip, 16 x 3mm  
1 Flacon of suture silk, sterile in alcohol



## Fine Wound Retractors (Dura- and Skin Retractors)

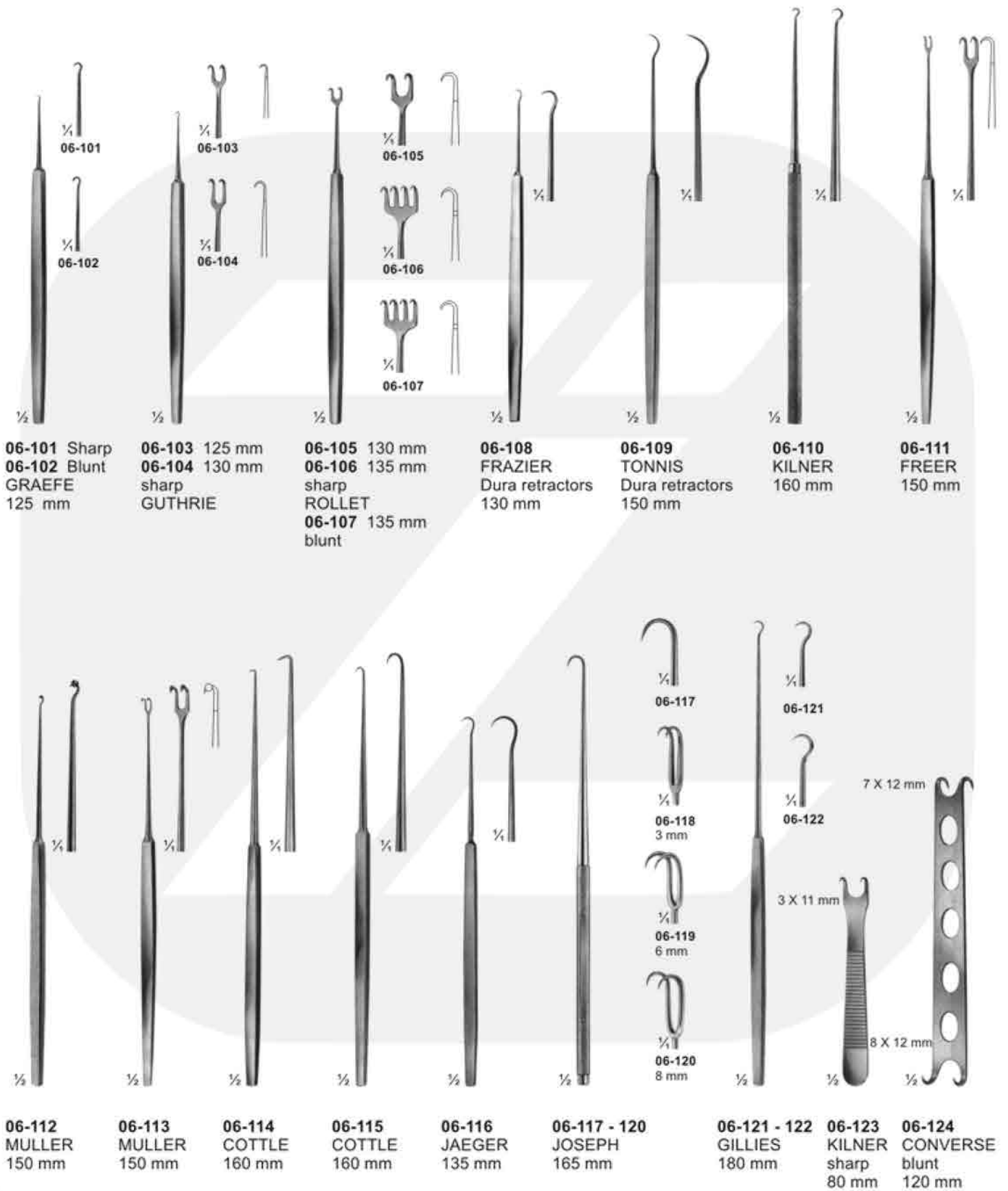



## Retractors With treangle handle

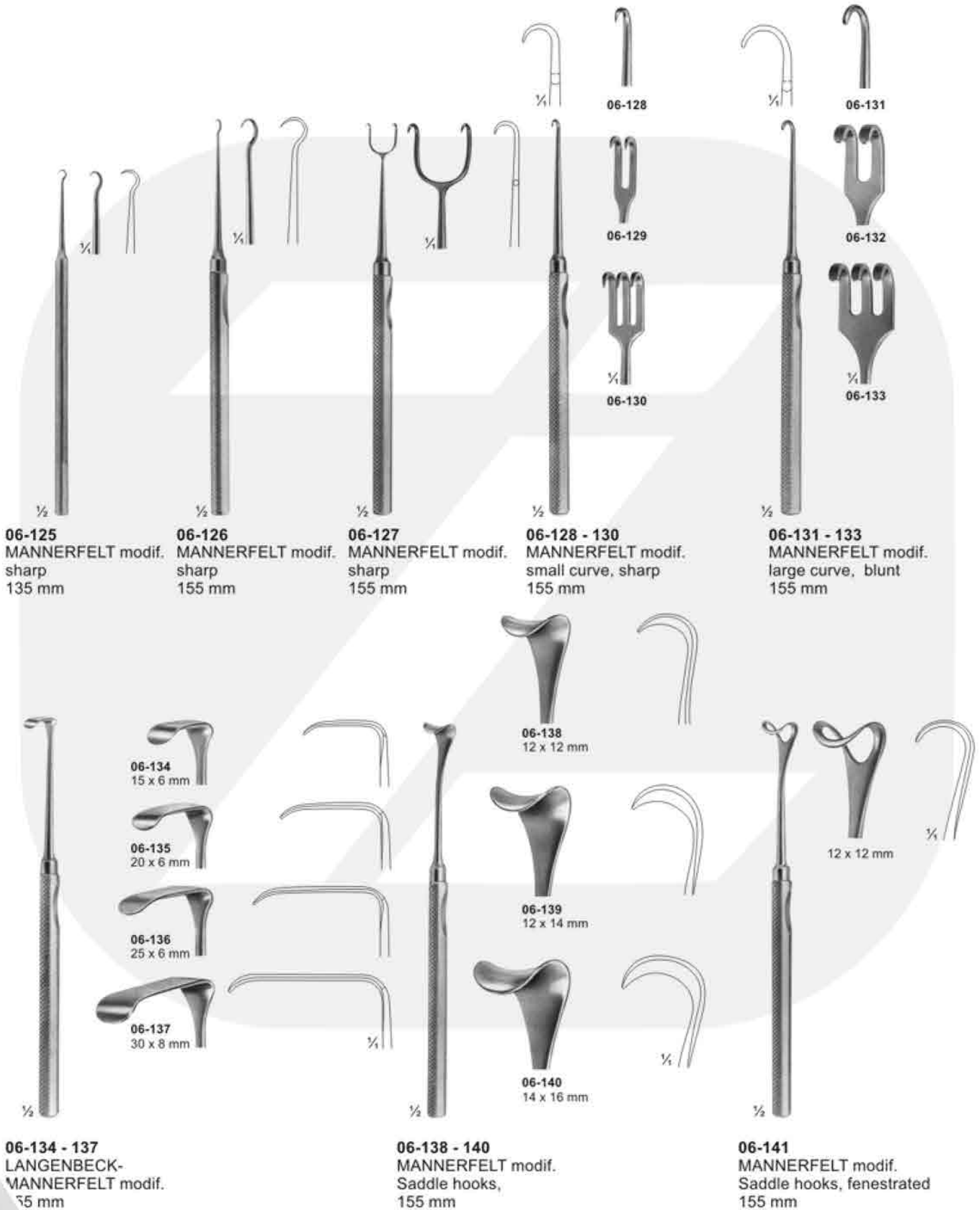

# Retractors

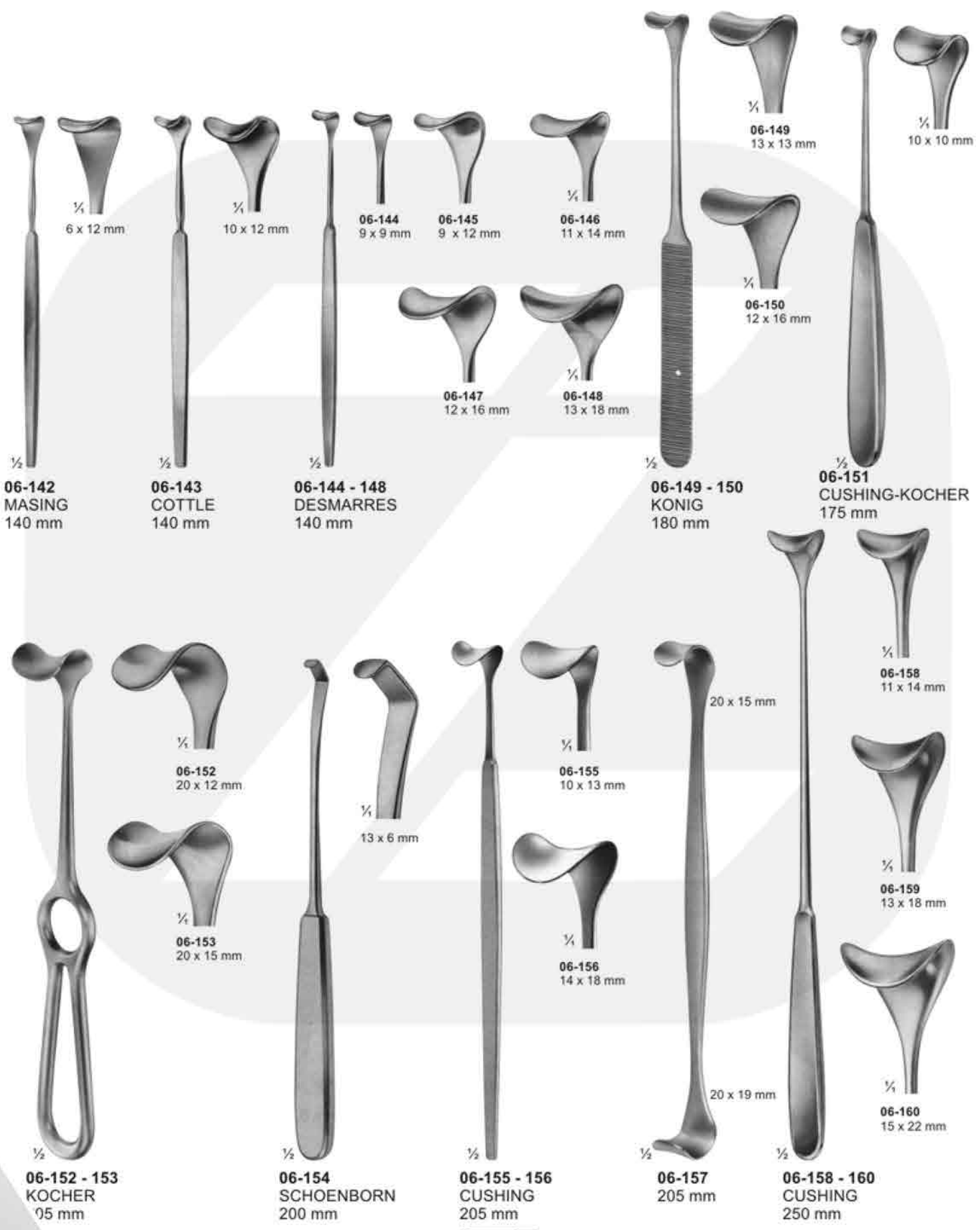

## Retractors



## Retractors



**06-169 - 06-170**  
BABY-SENN-MILLER  
155 mm

**06-171**  
SENN-MILLER  
165 mm

**06-172**  
COLLIN-HARTMANN  
150 mm

**STERBERG**  
**06-173** 120 mm  
**06-174** 130 mm  
**06-175** 135 mm  
**06-176** 140 mm

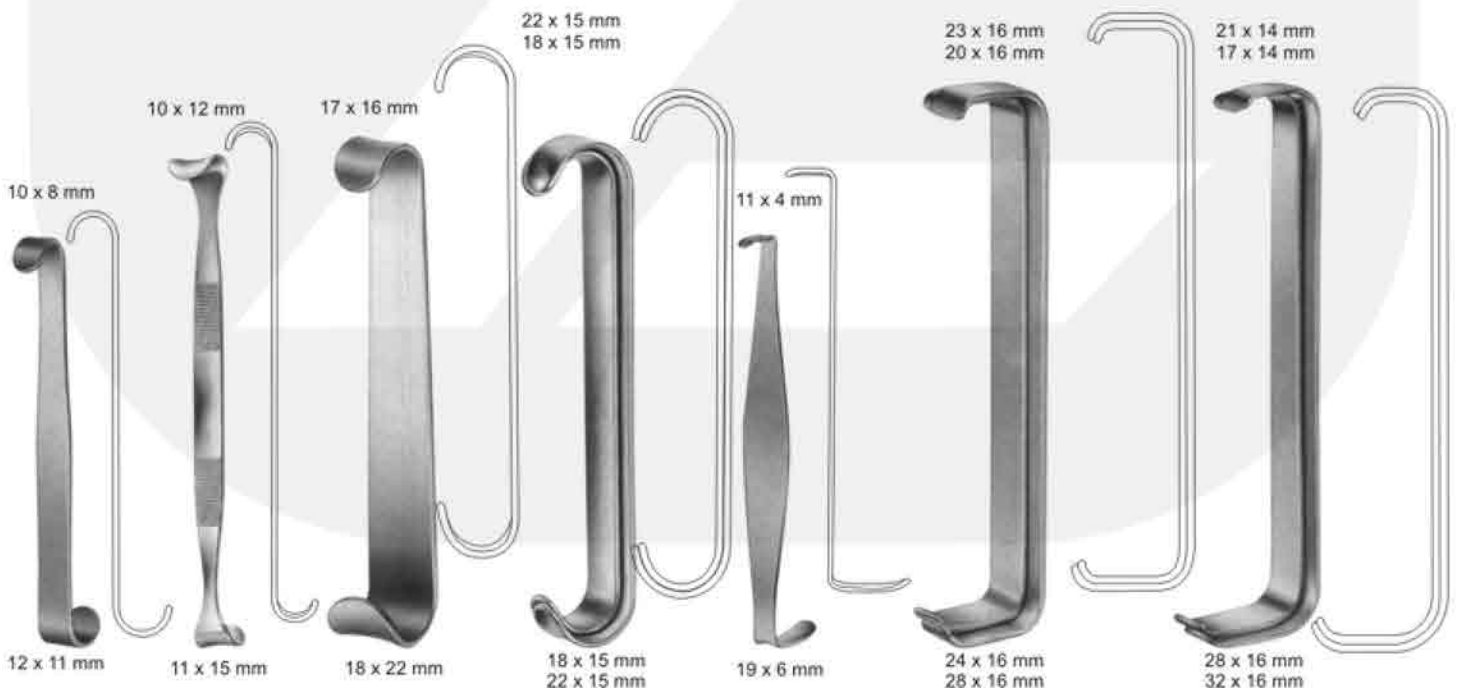

**06-177**  
LUER  
110 mm

**06-178**  
ROSE  
130 mm

**06-179**  
BABY-ROUX  
135 mm

**06-180**  
PARKER  
135 mm

**06-181**  
CRILE  
110 mm

**06-182**  
FARABEUF  
150 mm

**06-183**  
COLLIN  
150 mm



## Bone Retractors and Retractors



**06-184**  
KOCHER  
sharp  
205 mm



**06-185**  
KOCHER  
sharp  
220 mm



**06-186**  
KOCHER  
sharp  
220 mm



**06-187**  
VOLKMANN  
blunt  
220 mm



**06-188**  
VOLKMANN  
sharp  
220 mm



**06-189 - 06-196**  
VOLKMANN  
225 mm



Sharp



**06-189**  
9 x 8 mm



**06-190**  
9 x 13 mm



**06-191**  
9 x 19 mm



**06-192**  
9 x 29 mm



Blunt



**06-193**  
8,5 x 8 mm



**06-194**  
8,5 x 13 mm



**06-195**  
8,5 x 19 mm



**06-196**  
8,5 x 29 mm

## Retractors



## Retractors, Vario Retractor System

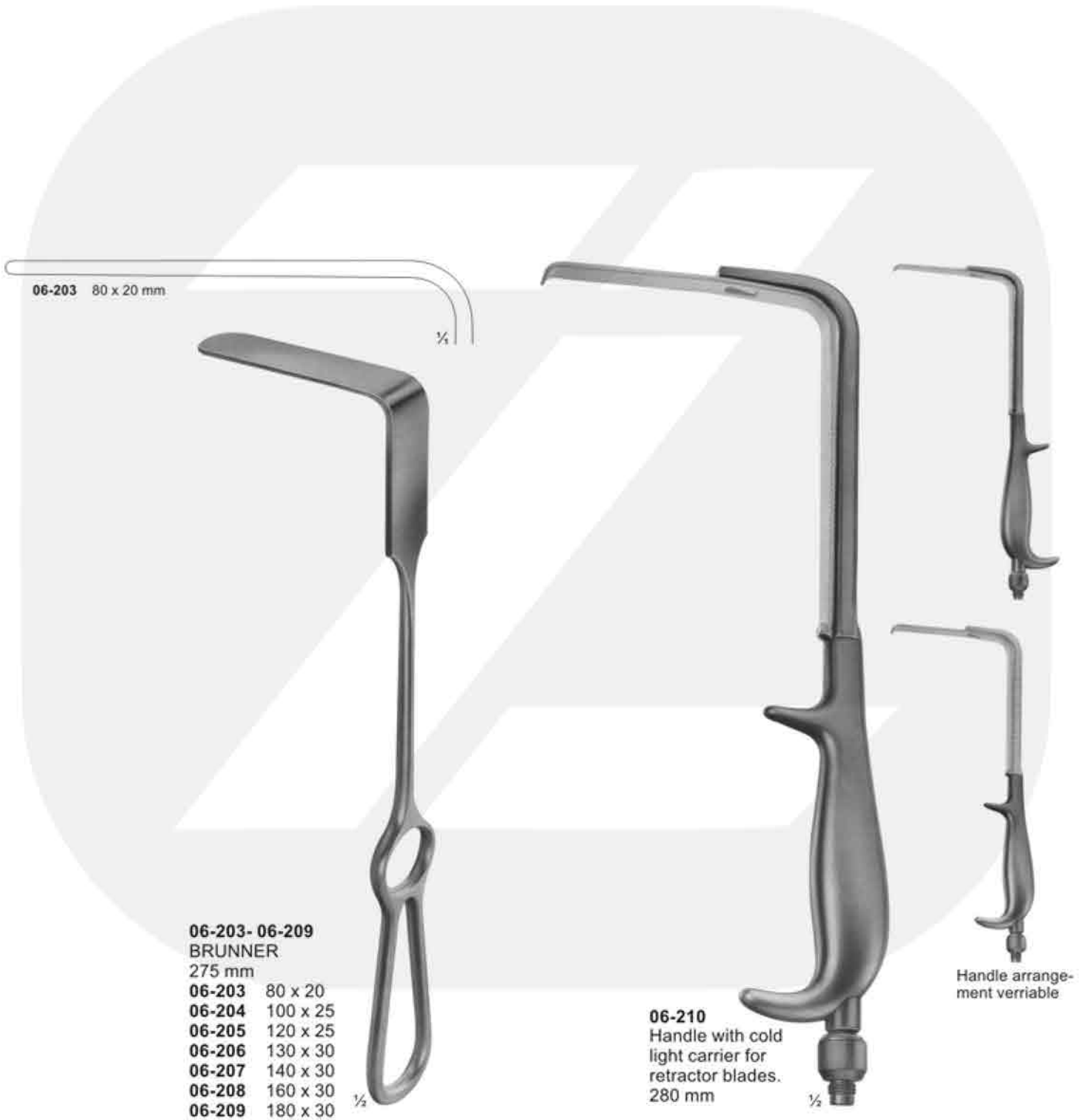

**06-203- 06-209**  
BRUNNER  
275 mm

- 06-203** 80 x 20
- 06-204** 100 x 25
- 06-205** 120 x 25
- 06-206** 130 x 30
- 06-207** 140 x 30
- 06-208** 160 x 30
- 06-209** 180 x 30

**06-210**  
Handle with cold  
light carrier for  
retractor blades.  
280 mm

Handle arrange-  
ment verriable

## Retractors, Lung Spatulas





**Retractors for deep surgery  
(Abdominal Retractors)**

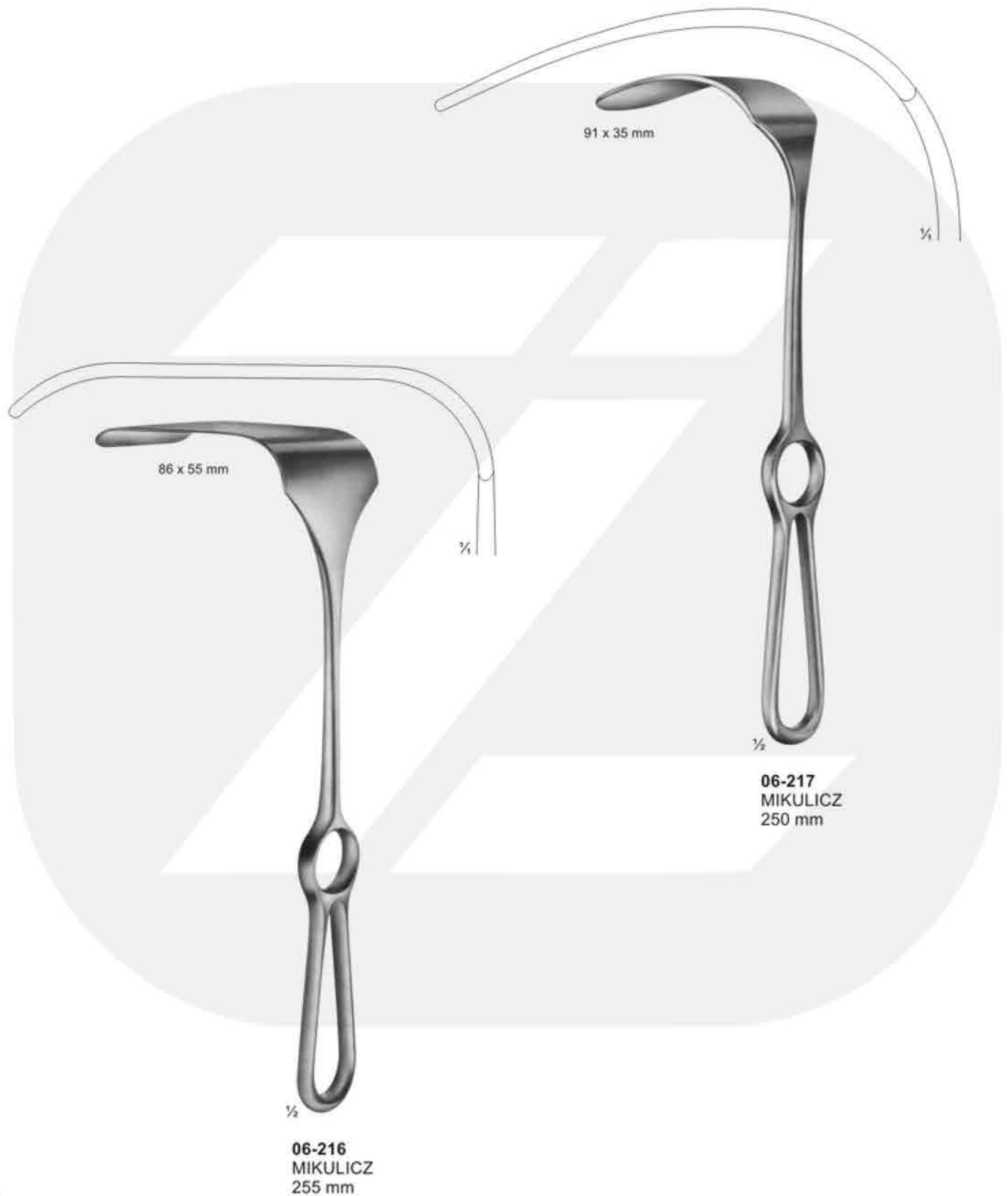

## Retractors, Abdominal Retractors

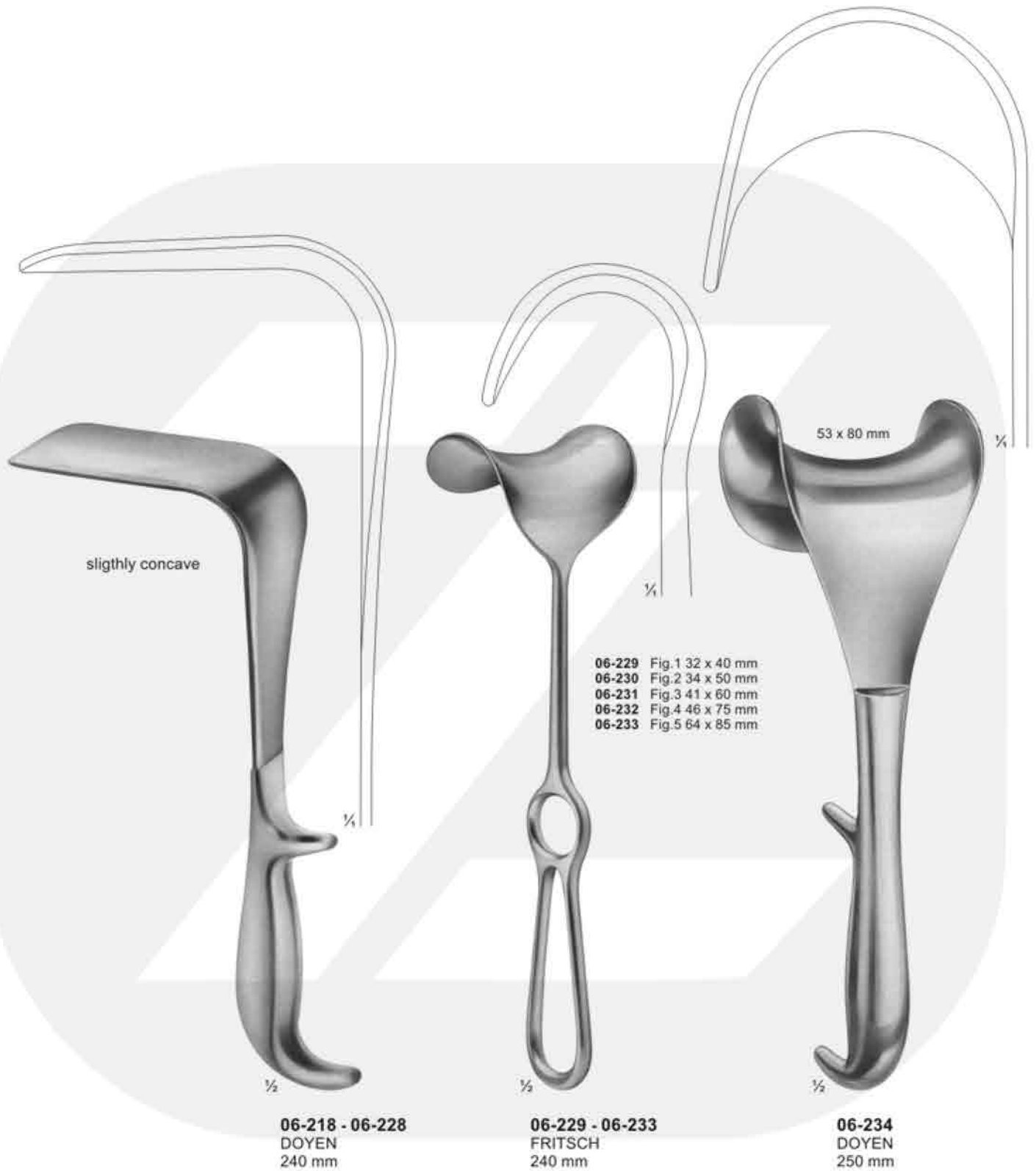

	width of blades	35 mm, 45 mm, 60 mm
length of blades		
62 mm	06-218 , 06-222 , 06-226	
92 mm	06-219 , 06-223 , 06-227	
122 mm	06-220 , 06-224 , 06-228	
160 mm	06-221 , 06-225	

**Abdominal- and Intestinal Spatulas  
Bauch- und Darmspatel**

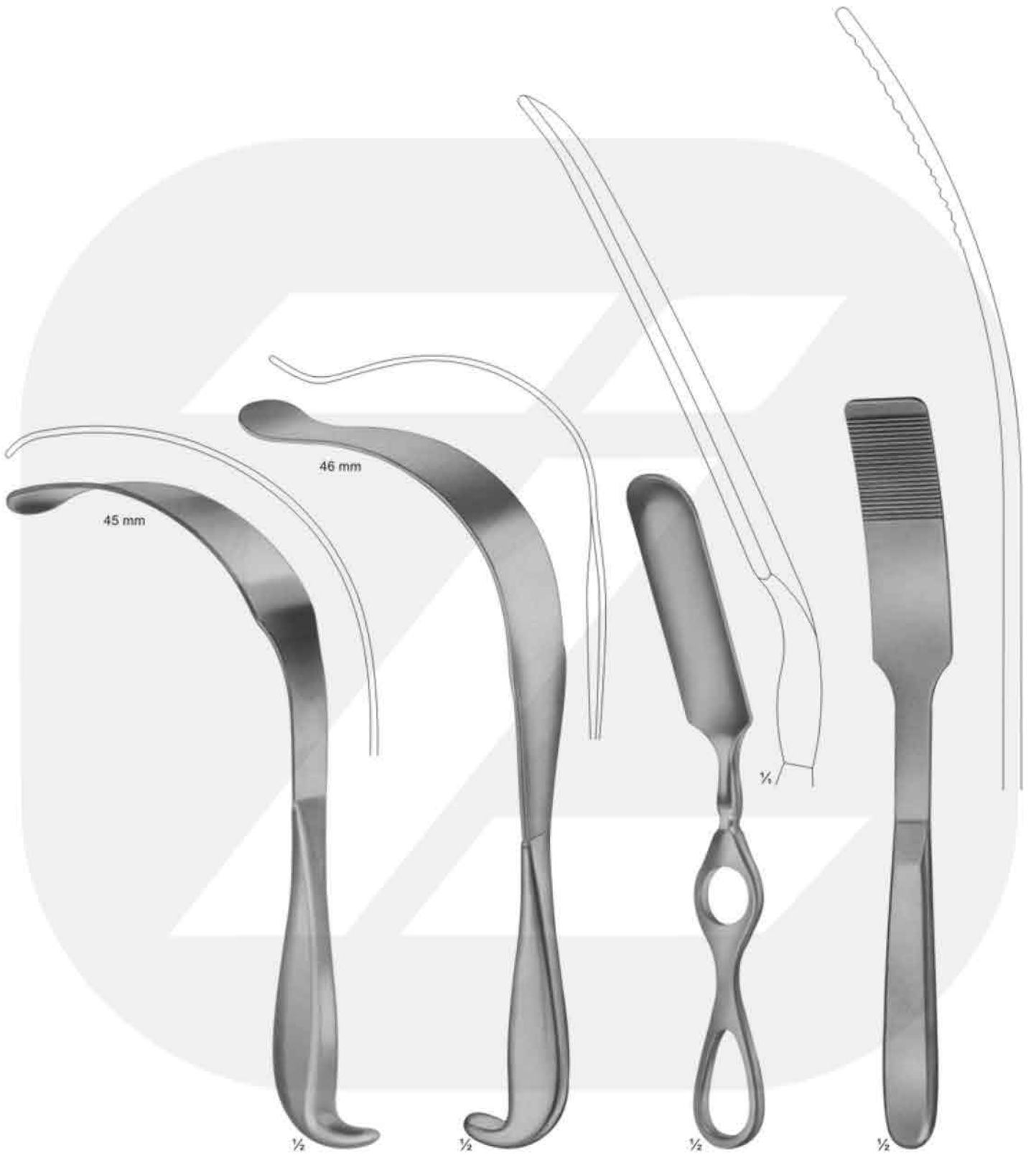

**06-235**  
LERICHE  
255 mm

**06-236**  
KUMMEL  
Mealleable  
285 mm

**06-237**  
MIKULICZ  
29 mm  
250 mm

**06-238 - 06-239**  
KADER  
**06-238** 30 mm  
**06-239** 40 mm  
270 mm

# Self-Retaining Retractors

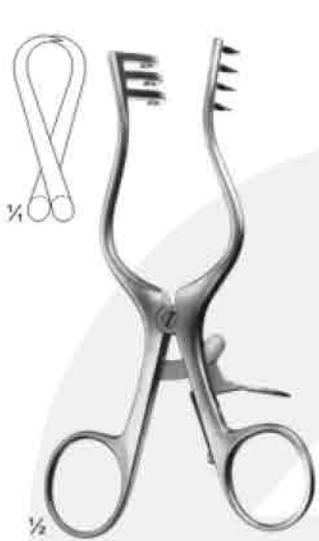

**06-240**  
WEITLANER  
sharp  
130 mm

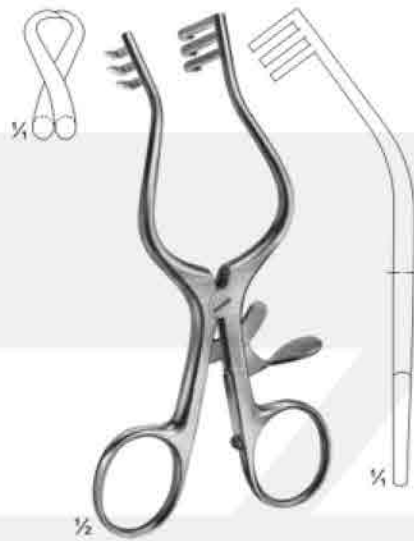

**06-241**  
WULLSTEIN  
sharp  
130 mm

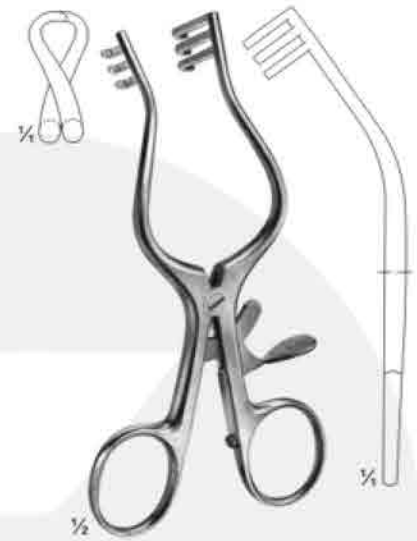

**06-242**  
WULLSTEIN  
blunt  
130 mm



**06-243**  
WEITLANER  
sharp  
165 mm



**06-244**  
PLESTER  
blunt  
110 mm



**06-245**  
PERKINS  
blunt  
130 mm



## Special Retractors



1/2

**06-246**  
JOLL ( FRIEDMAN )  
Thyroid- and vaginal retractor  
155 mm

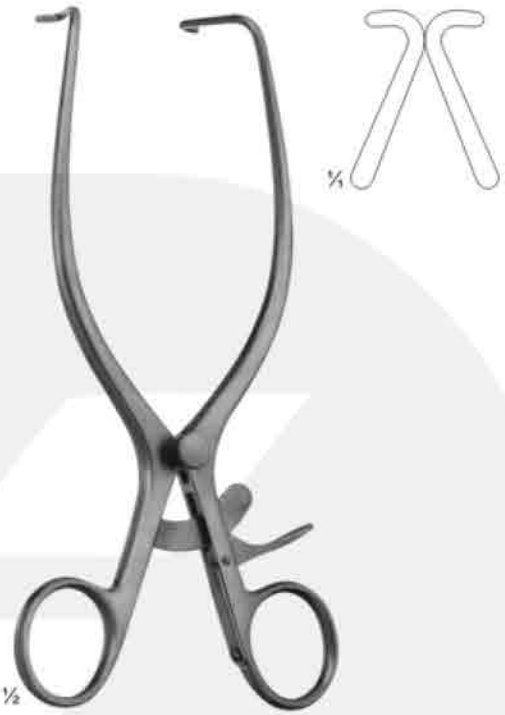

1/2

**06-247**  
JACKSON BURROWS  
Retractor, blunt  
185 mm



1/4



1/4



1/2

**06-248**  
GELPI  
Vaginal retractor  
135 mm



1/2

**06-249**  
GELPI  
Skin- and vaginal retractor  
175 mm

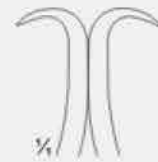

1/4



1/2

**06-250**  
DE BAKEY  
Femur retractor  
145 mm

## Lamina Spreaders



**06-251**  
CLOWARD  
155 mm



**06-252**  
CLOWARD  
135 mm



**06-253**  
INGE  
170 mm

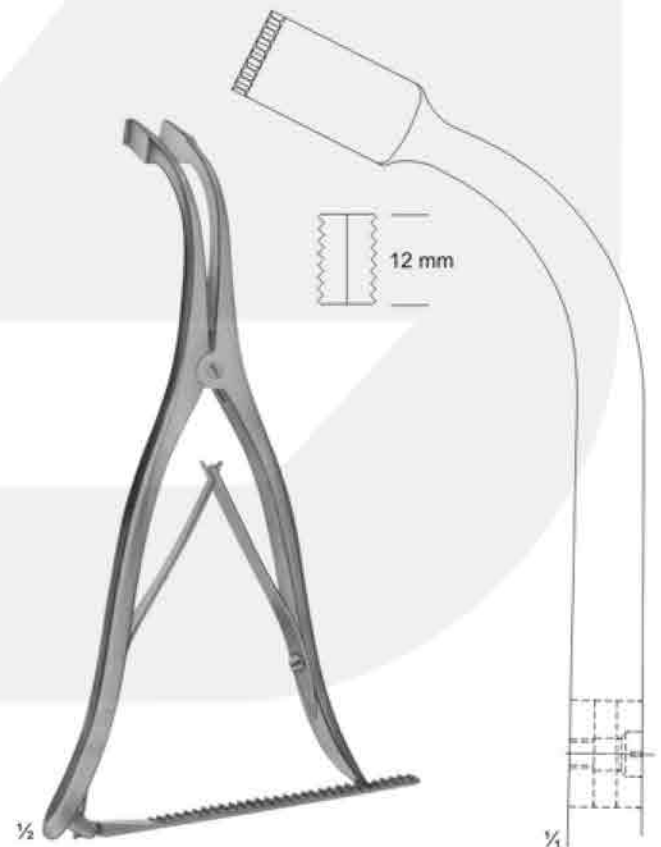

**06-254**  
INGE  
275 mm

## Abdominal Retractors



**06-255**  
GOSSET  
Blades: 38 mm deep

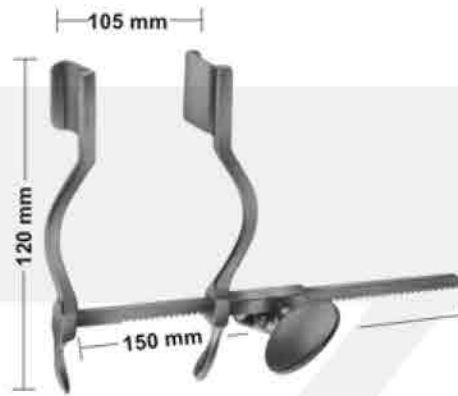

**06-256**  
HERTZLER  
Blades 20 X 25 mm

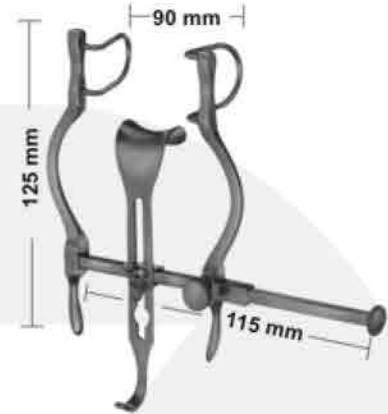

**06-257**  
BALFOUR-BABY  
Lateral blades 27 mm deep  
Center blade 21x24 mm

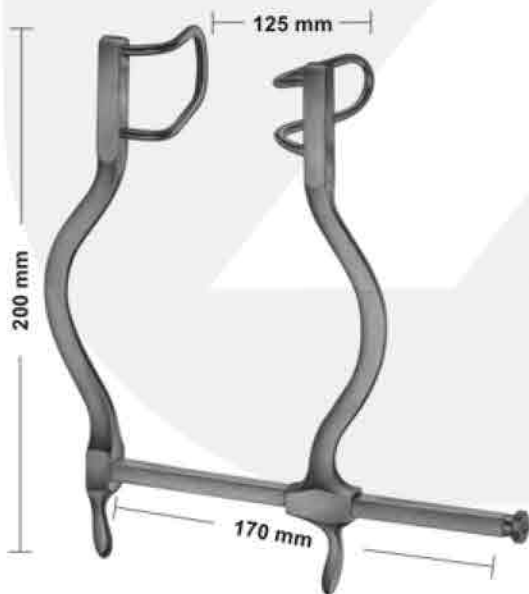

**06-258**  
GOSSET  
Blades: 55 mm deep

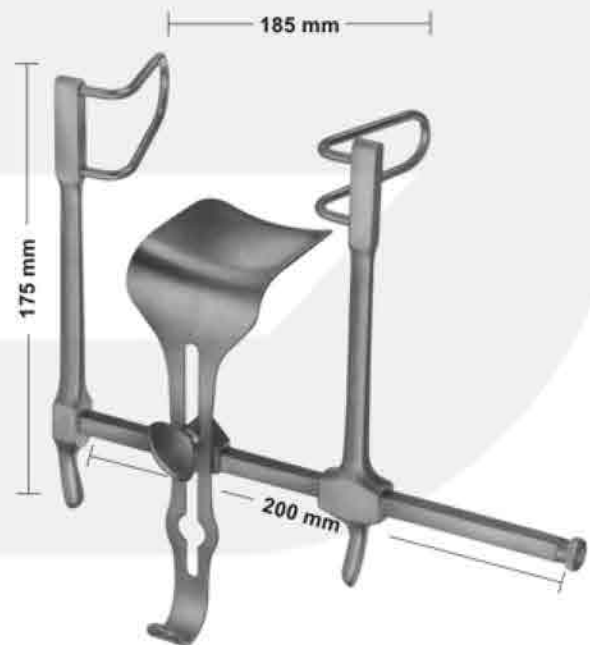

**06-259**  
GOSSET  
Lateral blades 58 mm deep  
Center blade 59 x 57 mm

# Abdominal Retractors

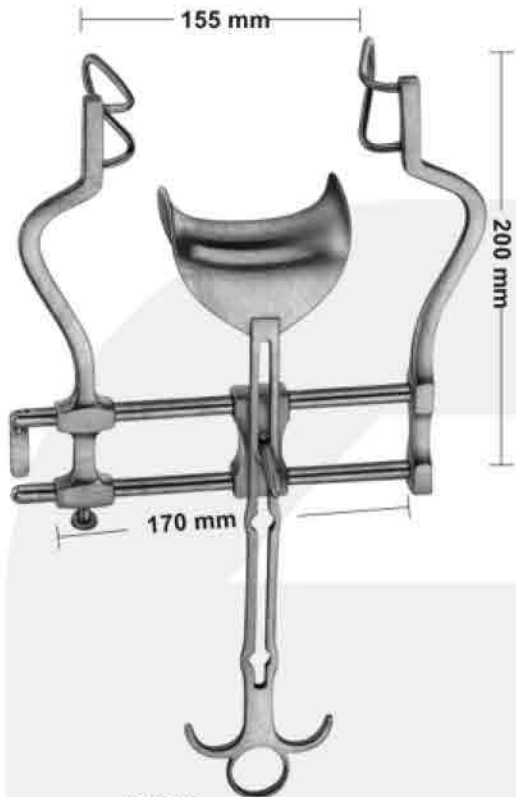

**06-260**  
BALFOUR  
Lateral blades 60 mm deep  
Center blade 47 x 80 mm

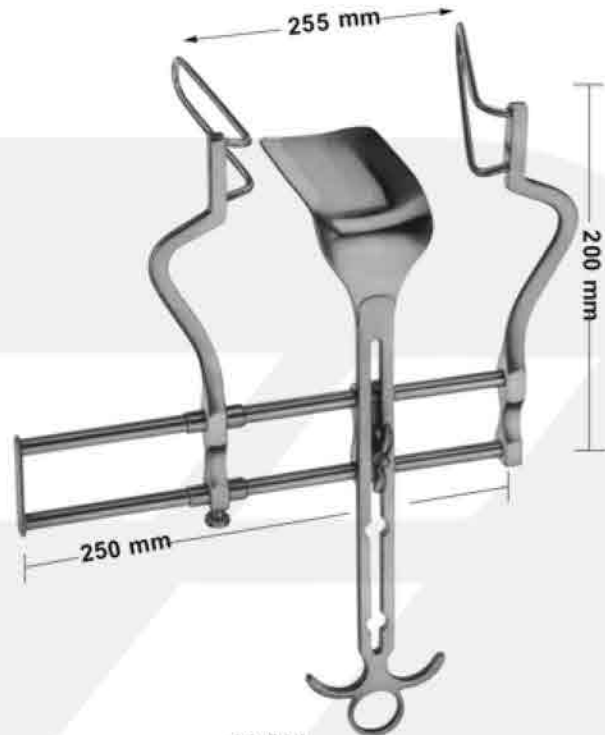

**06-261**  
BALFOUR  
Lateral blades 105 mm deep  
Center blade 107x 59 mm



**06-262**  
Center blade only  
54x80 mm

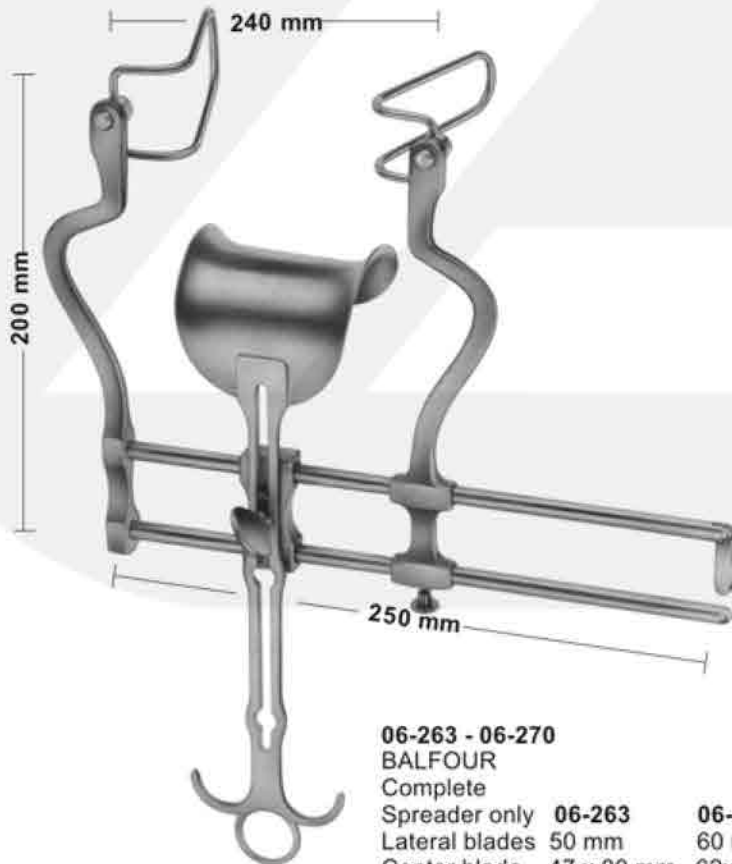

**06-263 - 06-270**  
BALFOUR  
Complete

Spreader only	<b>06-263</b>	<b>06-264</b>	<b>06-265</b>	<b>06-266</b>
Lateral blades	50 mm	60 mm	75 mm	90 mm
Center blade	47 x 80 mm	62x76 mm	80x80 mm	80x80 mm



Lateral blades  
**06-267** 50 mm deep  
**06-268** 60 mm deep  
**06-269** 75 mm deep  
**06-270** 90 mm deep  
 Sales Unit of blades:PR = pair



## Organ-, Tissue and Intestinal Grasping Forceps

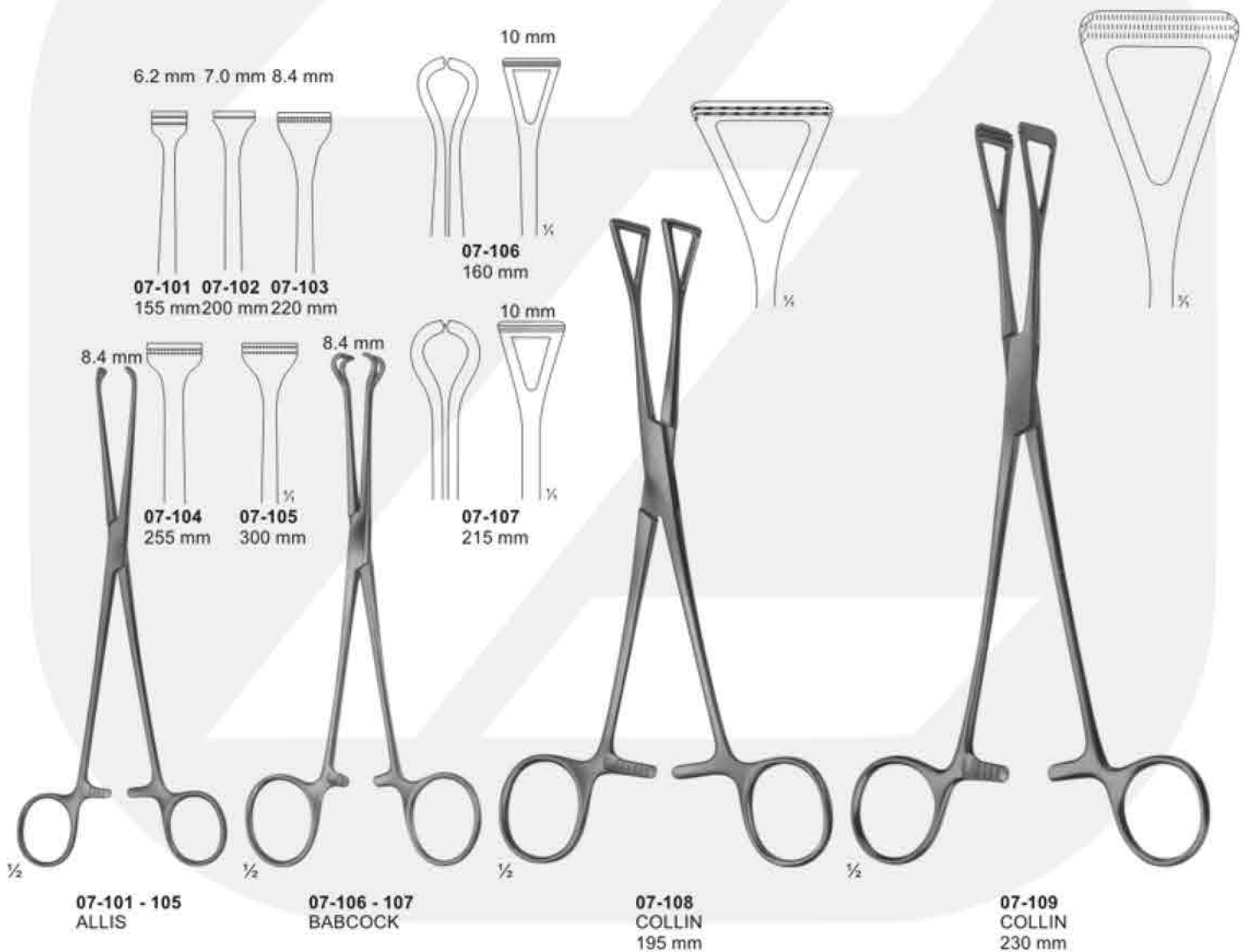

**Intestinal Clamps, soft elastic**

**ATRAUMATA**

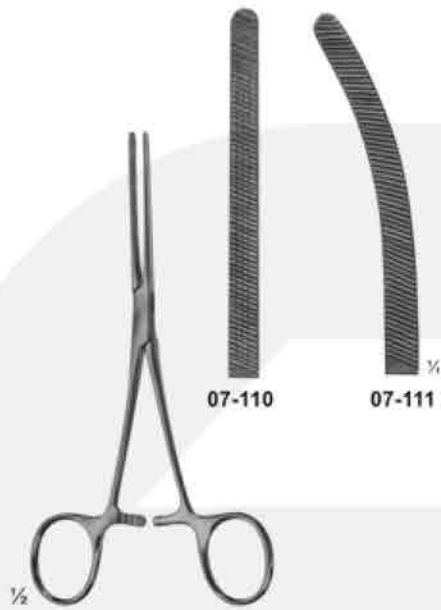

**07-110 - 111**  
**DOYEN**  
elastic  
165 mm

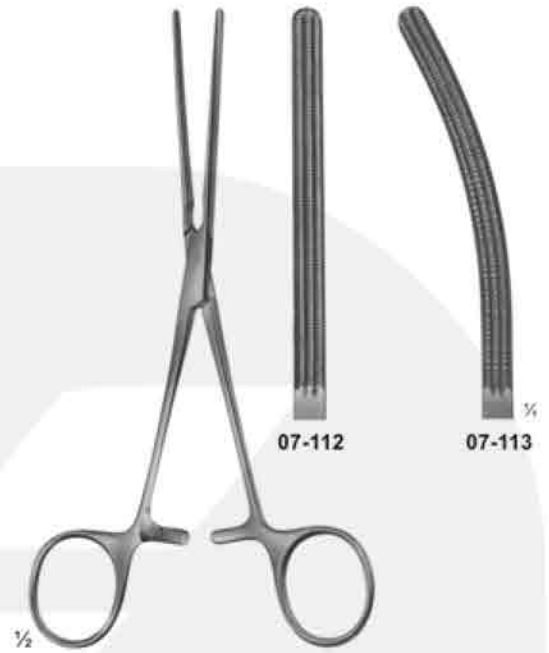

**07-112 - 113**  
**DOYEN**  
with elastic blades  
170 mm

**ATRAUMATA**

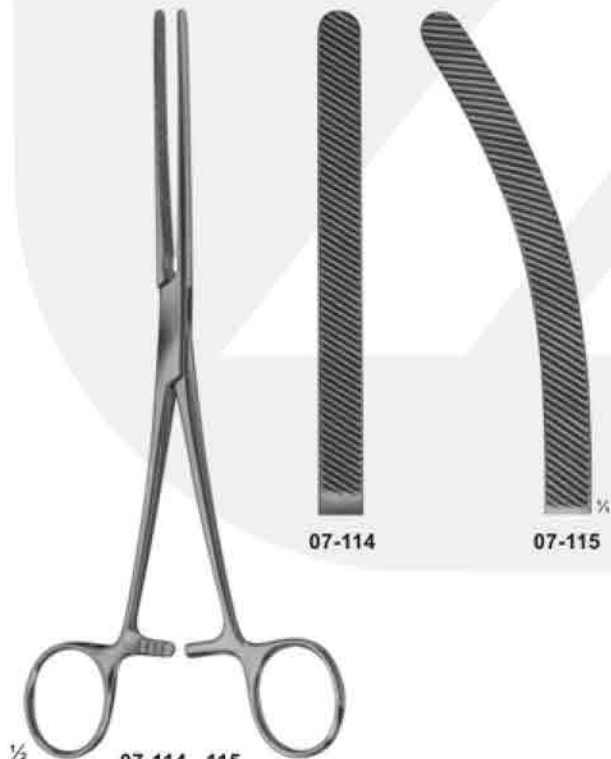

**07-114 - 115**  
**HARTMANN**  
with elastic blades  
200 mm



**07-116 - 117**  
**HARTMANN**  
with elastic blades  
200 mm

## Intestinal and Pylorus Clamps



1/2  
**07-118**  
PAYR  
Intestinal clamp  
light pattern,  
for children  
180 mm

1/2  
**07-119**  
PAYR  
200 mm

1/2  
**07-120**  
PAYR  
275 mm

1/2  
**07-121**  
PAYR  
Pylorus clamp  
315 mm

**ATRAUMATA**  
**Sigmoid Anastomosis Forceps**

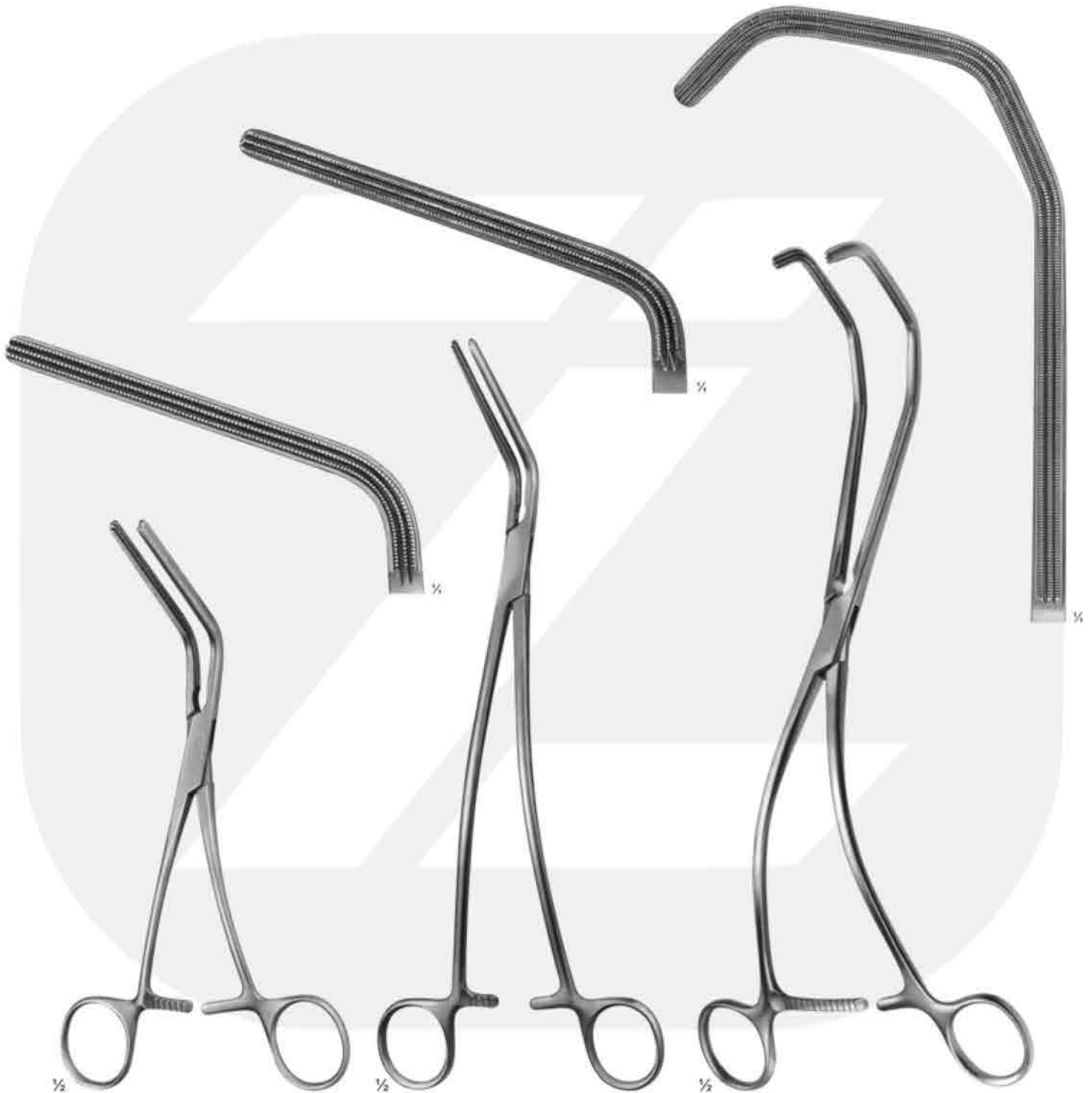

**07-122**  
**MORRIS**  
175 mm

**07-123**  
**DE BAKEY**  
(MORRIS modif.)  
240 mm

**07-124**  
**KERSTING**  
270 mm



# Nasal Specula



**08-101**  
Martin  
13 cm / 5 1/8"



**08-102**  
SIMS  
160 mm

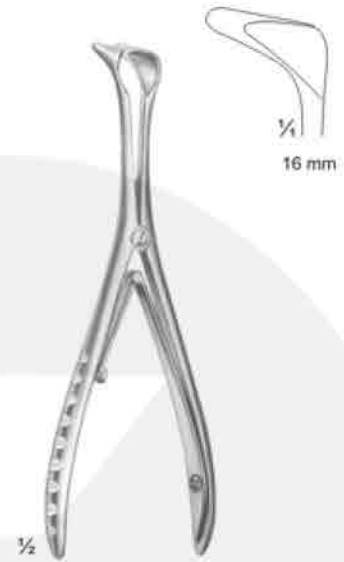

**08-103**  
Tieck-Halle  
13 cm / 5 1/8"



**08-104**  
Killian

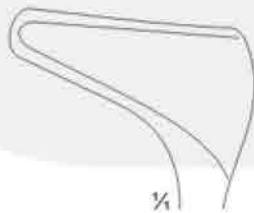

**Fig. 1**  
14 cm 5 4/8"  
35 mm

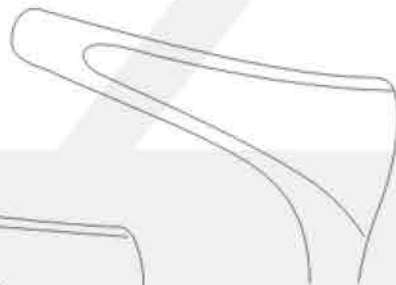

**Fig. 2**  
14,5 cm / 5 4/8"  
50 mm

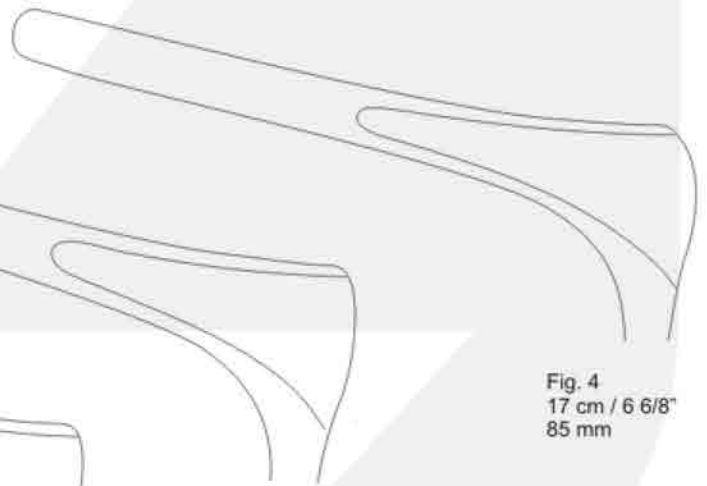

**Fig. 3**  
16 cm / 6 2/8"  
75 mm

**Fig. 4**  
17 cm / 6 6/8"  
85 mm

# Nasal Specula



**08-105**  
Cottle

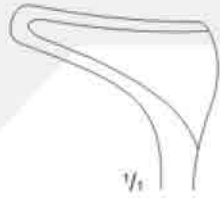

Fig. 1  
13,5 cm / 5 3/8"  
35 mm



Fig. 2  
14 cm / 5 4/8"  
50 mm

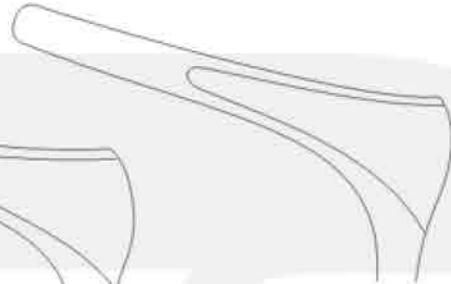

Fig. 3  
16 cm / 6 2/8"  
75 mm

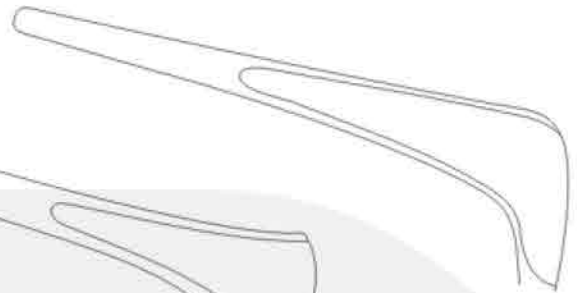

Fig. 4  
16 cm / 6 2/8"  
85 mm



**08-106**  
Goldsmith (Thudichum)  
6,5 cm / 2 4/8"



Fig. 1  
21,0 x 9,5 mm



Fig. 2  
21,0 x 10,5 mm



Fig. 3  
21,0 x 11,5 mm



**08-107**  
Mod. Wien 2  
13,5 cm / 5 1/8"



Fig. 1  
30 mm



**08-108**  
Hartmann-Halle  
16 cm / 6 1/8"



Fig. 1  
27 mm



Fig. 2  
31 mm



Fig. 3  
35 mm

## Anuscopy-Sphincteroscopes



**08-109**  
IVES-FANSLER  
Anuscopy  
145 mm  
Ø24mm



**08-110**  
KELLY  
Sphincteroscope  
160 mm  
Ø21mm



**08-111**  
KELLY  
Sphincteroscope  
160 mm  
Ø27mm

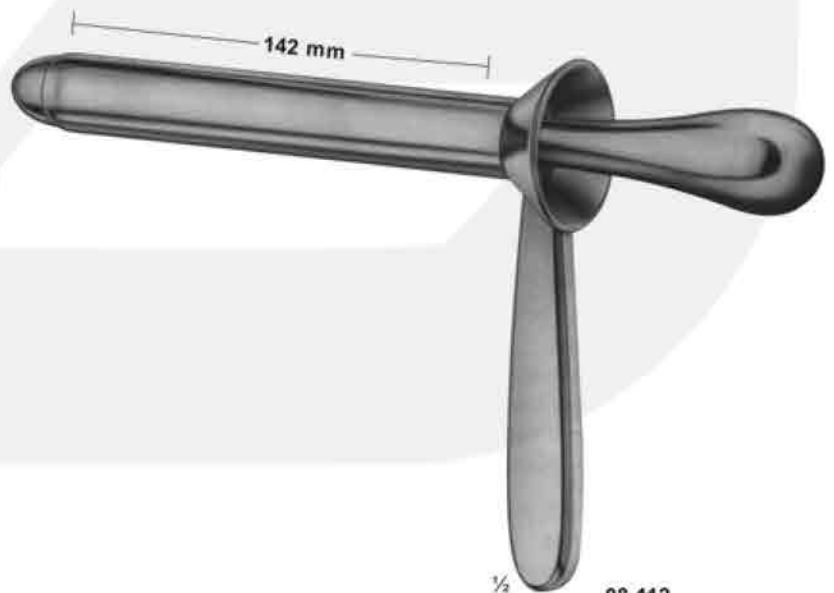

**08-112**  
KELLY  
Proctoscope  
140 mm  
Ø22mm

# Haemorrhoidal Forceps

## ATRAUMATA

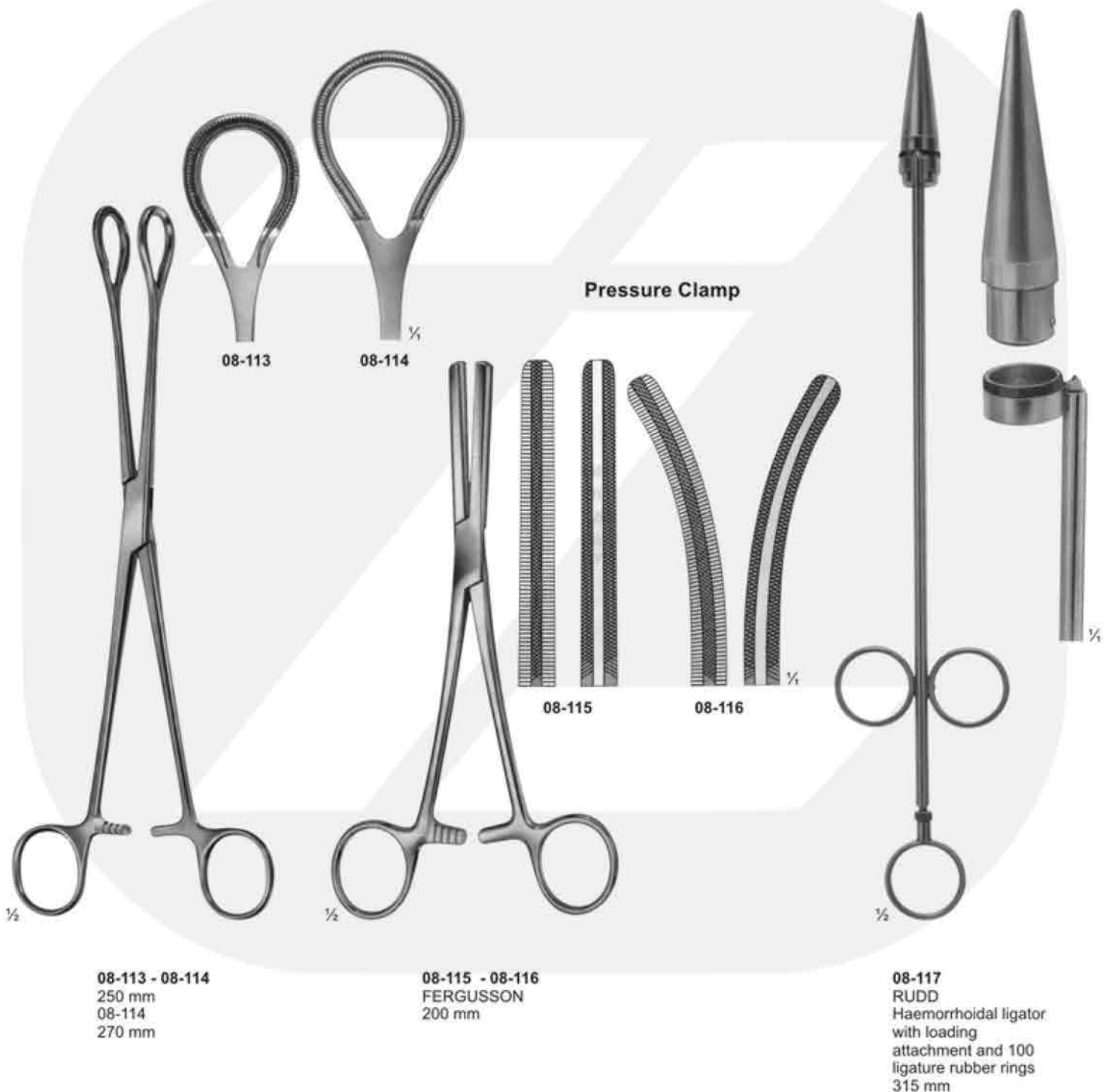

Pressure Clamp

08-113 - 08-114  
250 mm  
08-114  
270 mm

08-115 - 08-116  
FERGUSSON  
200 mm

08-117  
RUDD  
Haemorrhoidal ligator  
with loading  
attachment and 100  
ligature rubber rings  
315 mm



## Gall Duct Forceps



**08-118**  
LOWER  
180 mm



**08-119**  
LAHEY ( SWEET )  
190 mm

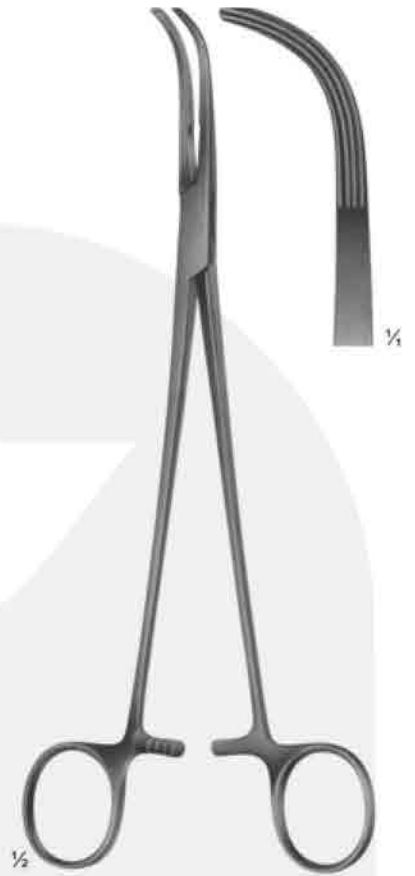

**08-120**  
LAHEY  
220 mm



**08-121**  
DESJARDINS  
Gall duct-and cystic forceps  
210 mm



**08-122**  
NISSEN  
Gall duct-and cystic forceps  
215 mm

# Gall Duct Dilators and Gall Stone Scoops

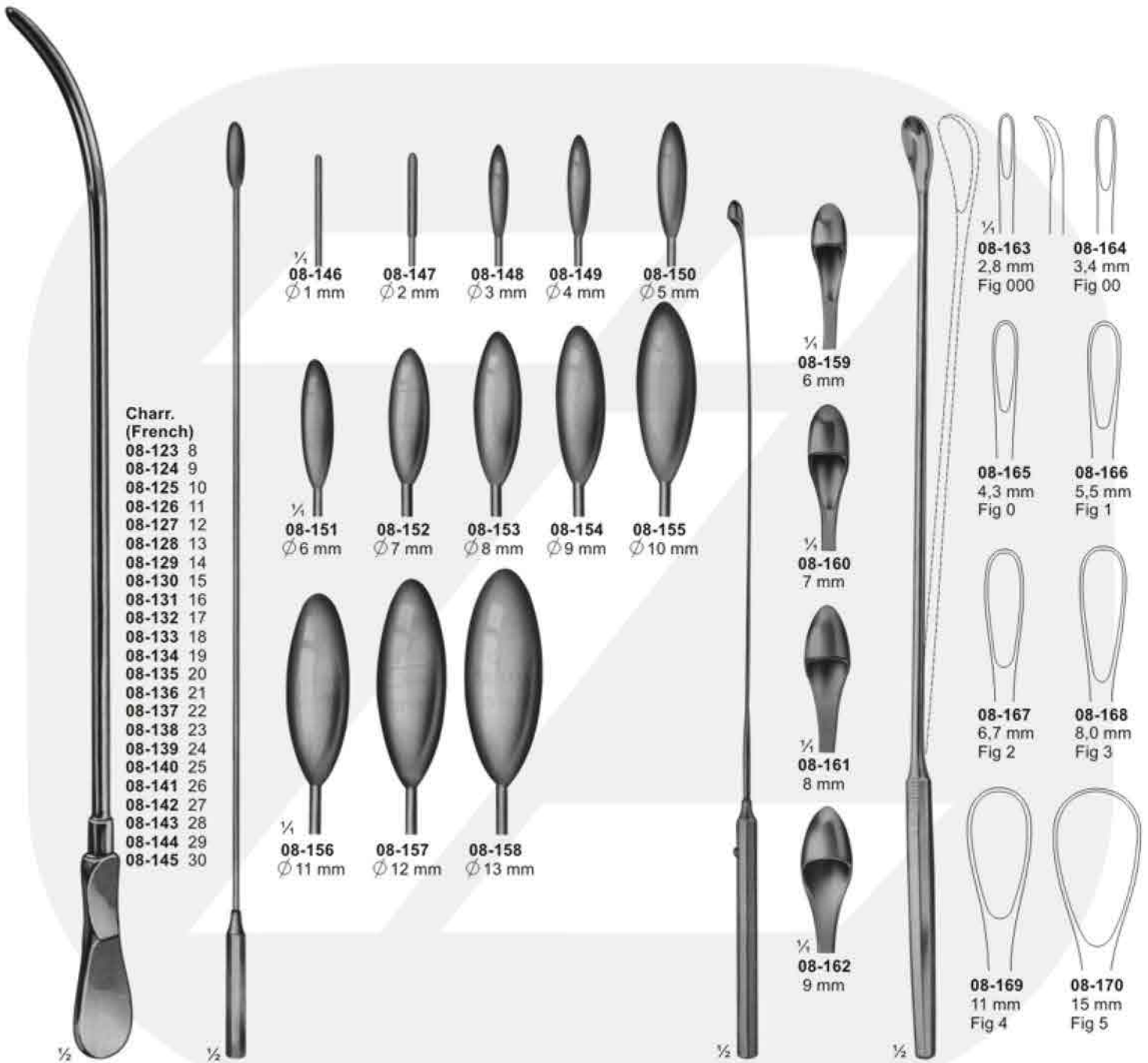

**08-123 - 08-145**  
DITTEL  
Metall bougies and dilating sounds, stiff  
345 mm

**08-146 - 08-158**  
BAKES  
Common bile duct dilators, malleable  
08-146 - 08-150 315 mm  
08-151 - 08-158 320 mm

**08-159 - 08-162**  
DESJARDINS  
Probe and catch with flexible schaft  
300 mm

**08-163 - 08-170**  
LUER-KOERTE modif with malleable shaft  
310 mm

## Gall Stone Forceps

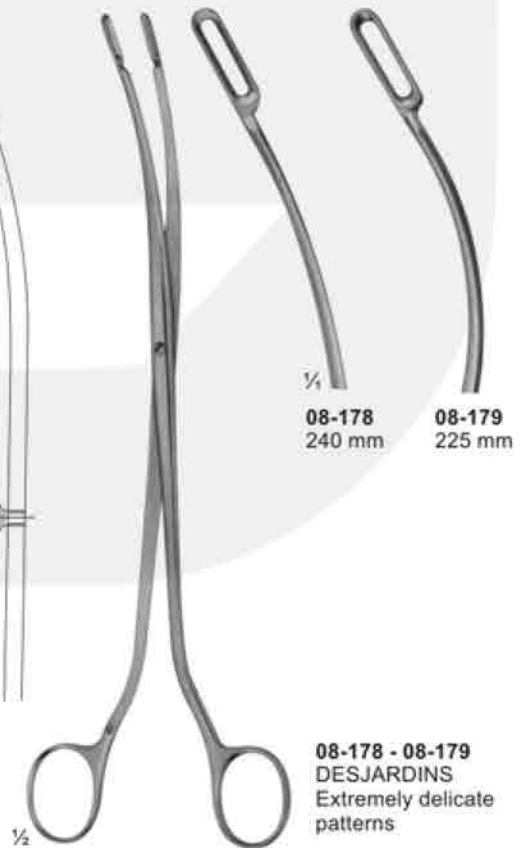
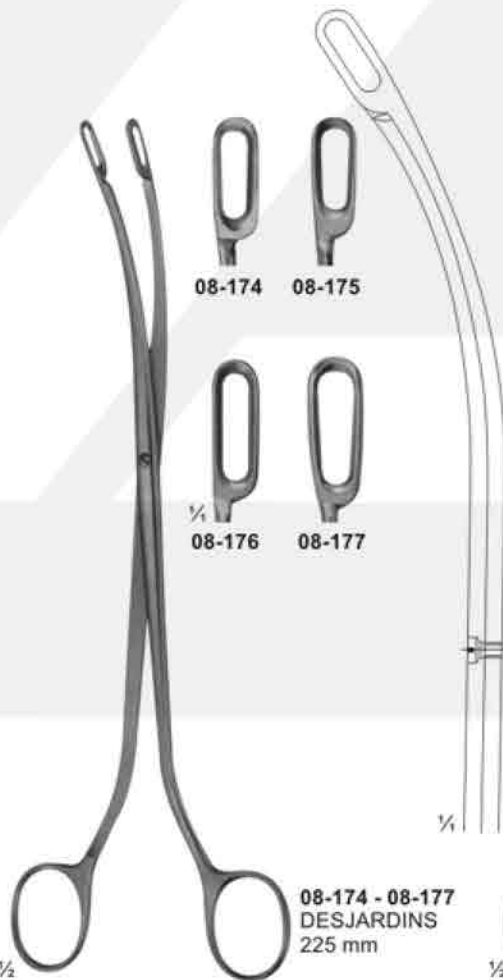
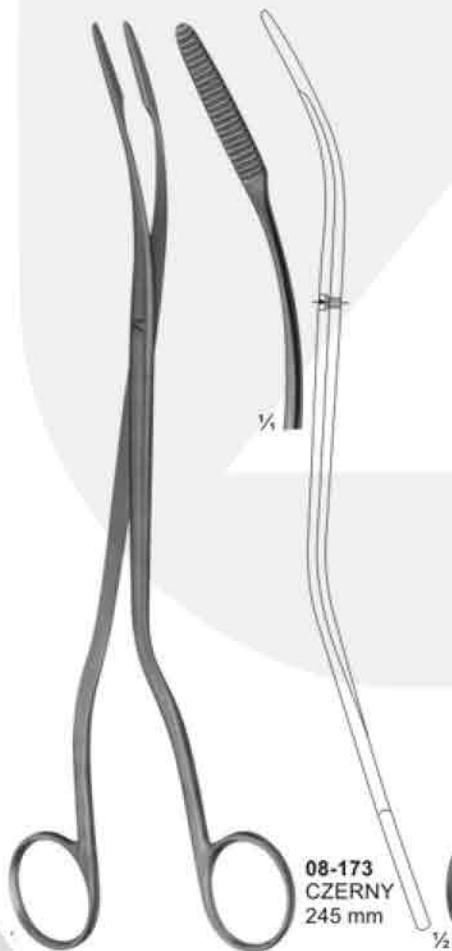
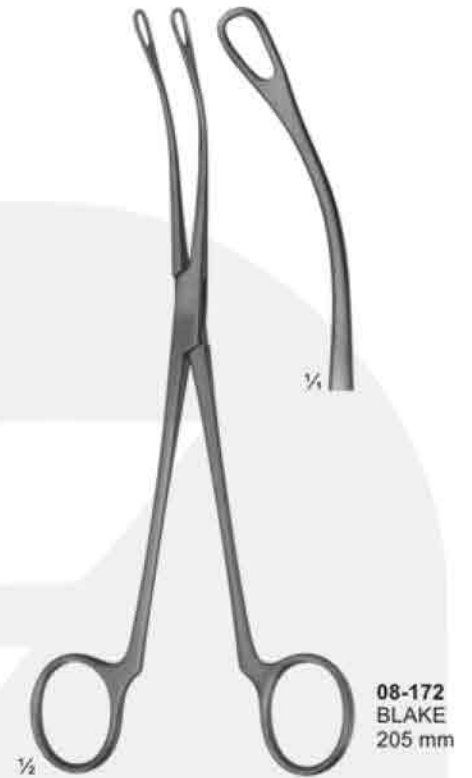

# Kidney Clamps

## ATRAUMATA

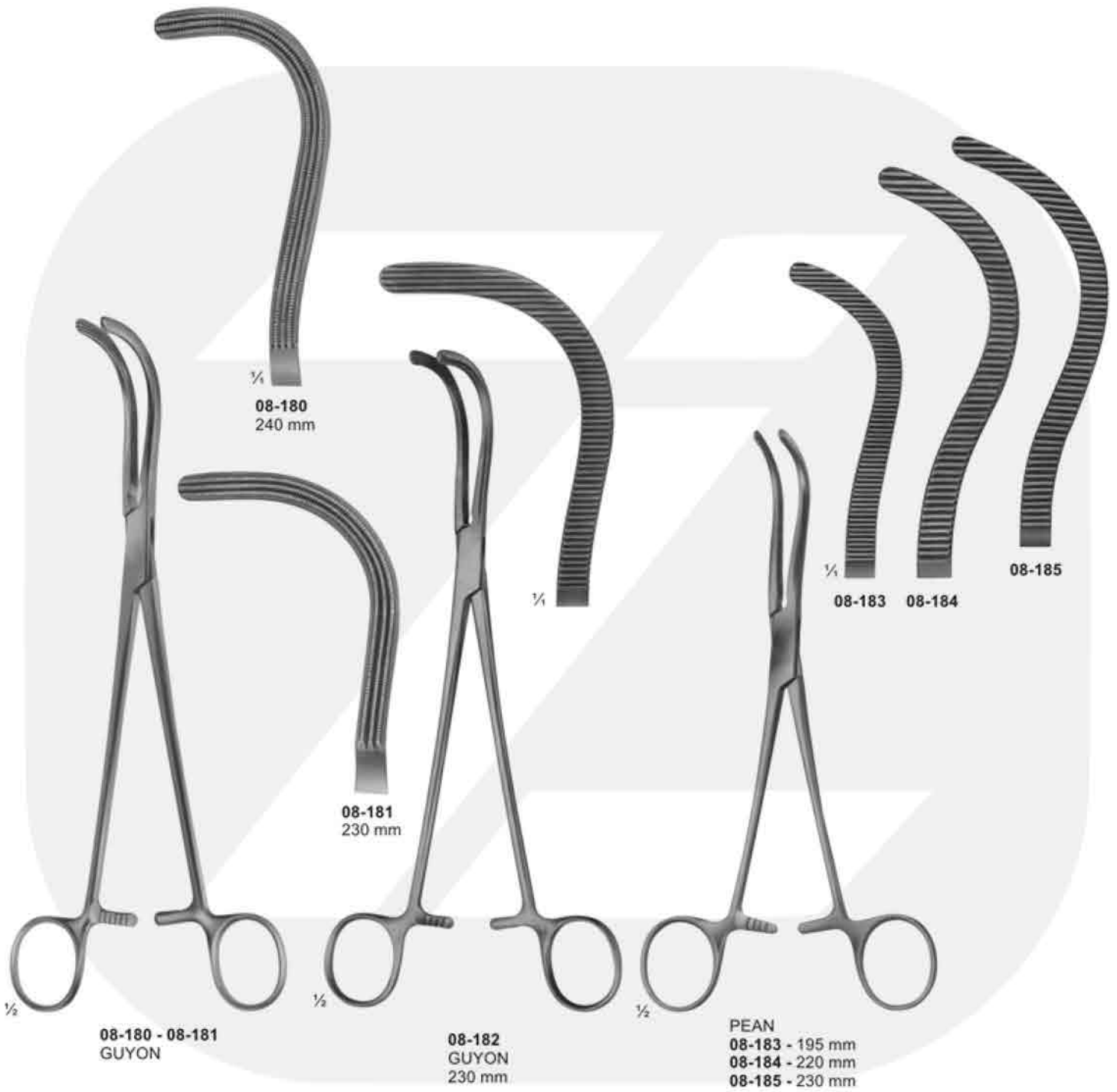



# Kidney Stone Forceps



08-186



08-187



08-188



1/4  
08-189



08-190



08-191



1/4  
08-192



1/2

08-186 - 08-189  
RANDALL  
225 mm



1/2

08-190 - 08-192  
RANDALL  
190 mm

## Bladder Retractors

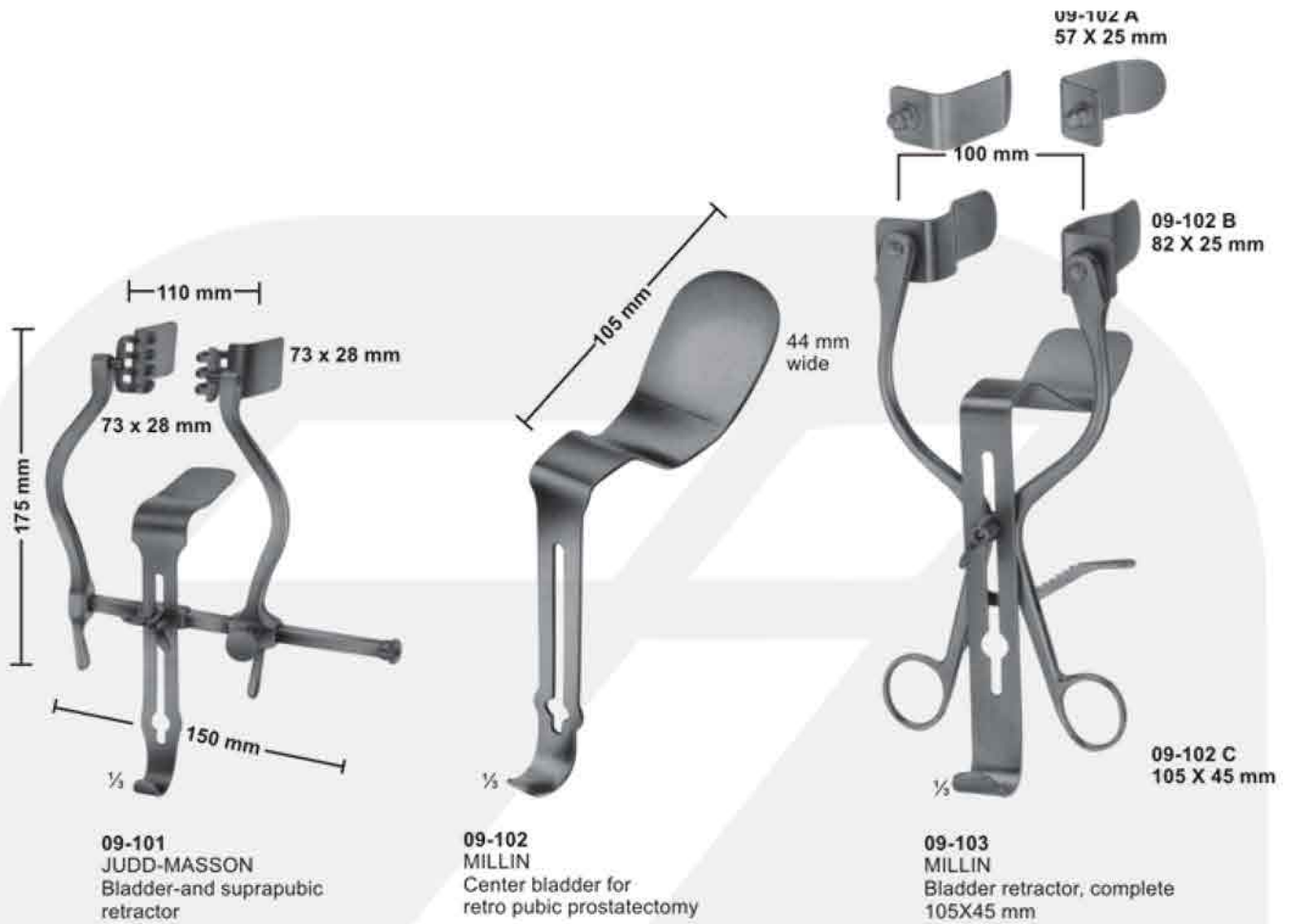

# Trocars



**09-106**  
KLIMA ROSEGGER  
35 X 1,8 mm  
Sternal puncture needle

**09-107**  
Universal trocar  
with 4 tips

NELSON

**09-113 - 116**  
Inside dime. Outside dime  
**09-113** 2,2 mm 3,0 mm  
**09-114** 3,0 mm 4,0 mm  
**09-115** 4,0 mm 5,0 mm  
**09-116** 5,0 mm 6,0 mm  
for abdominal puncture,  
with stop-cock and lateral  
drain

**09-108 - 112**  
Inside diam. Outside diam  
**09-108** 2,2 mm 3,0 mm  
**09-109** 3,0 mm 4,0 mm  
**09-110** 4,0 mm 5,0 mm  
**09-111** 5,0 mm 6,0 mm  
**09-112** 5,5 mm 6,5 mm  
for hydrocele and abdominal  
puncture



**09-117 - 118**  
Inside diam. Outside diam  
**09-117** 6,5 mm 8,0 mm  
**09-118** 9,0 mm 10,0 mm  
Empyema trocar  
BUELEU

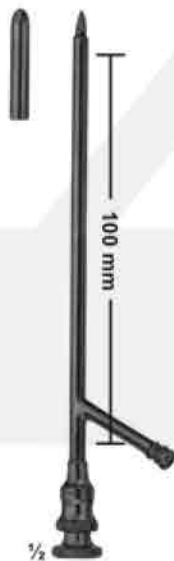

**09-119 - 122**  
Inside diam. Outside diam  
**09-119** 3,0 mm 4,0 mm  
**09-120** 3,6 mm 4,6 mm  
**09-121** 4,3 mm 5,3 mm  
**09-122** 5,0 mm 6,0 mm  
Gall bladder trocars. OCHSNER



**09-123**  
PIERCE  
Antrum trocar  
Ø 4,0 mm



**09-124**  
COAKLEY  
Antrum trocar  
3,0 mm

# Vaginal Specula



**10-101**  
COLLIN  
for children  
53 x 10 mm

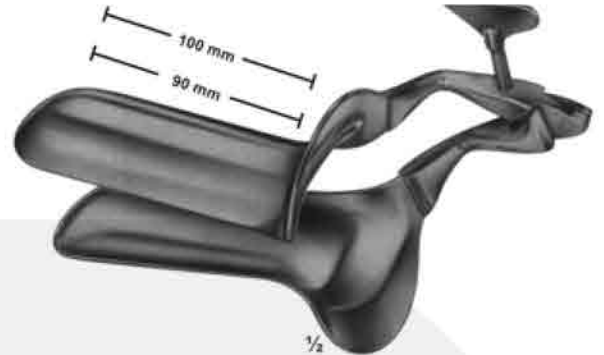

**10-102 - 105**  
COLLIN  

10-102	100/90mm	28 mm
10-103	100/90mm	32 mm
10-104	105/95mm	35 mm
10-105	115/105mm	40 mm

 Total length/working length width



**10-106**  
COLLIN  
for virgins  
95/85 x 18 mm



**10-107**  
CUSCO  
for virgins  
75 x 17 mm



**10-108**  
CUSCO  
for virgins  
75 x 17 mm

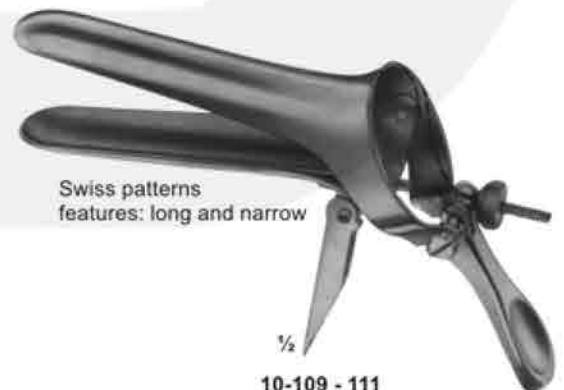

Swiss patterns  
features: long and narrow

**10-109 - 111**  
CUSCO  

10-109	92X23-25 mm
10-110	100x25-27 mm
10-111	110x27-30 mm



## Vaginal Specula- Sets, upper and lower blades



10-112 - 114  
GRAVE  
10-112 75X20 mm  
10-113 95X30 mm  
10-114 105X33 mm

½



10-115 - 116  
PEDERSON  
10-115 100X22 mm  
10-116 120X25 mm

½



10-117 - 118  
BRIESKY  
10-117 72X25 mm / 77X30 mm 140 mm  
10-118 75X30 mm / 92X38 mm 170 mm

½



10-119  
SIMS  
70 X 26 mm / 75 X 30 mm  
75 X 30 mm / 80 X 35 mm  
80 X 36 mm / 90 X 40 mm  
75 mm

½

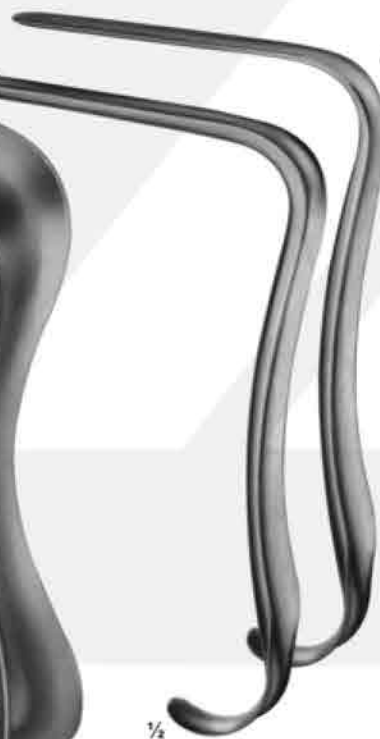

10-120 - 122  
SEIDL  
10-120 80X8 mm  
10-121 80X10 mm  
10-122 90X14 mm  
For children and infants  
170 mm

½



10-123  
KRISTELLER  
70X15 mm, ( 170 mm )  
For children

½



10-124 - 10-126  
KRISTELLER  
10-124 70X27 mm  
10-125 75X30 mm  
10-126 90X36 mm  
175 mm

½

## Vaginal Specula- upper and lower blades



10-132 75X10 mm  
175 mm

10-136 70X15 mm  
175 mm

10-133 75X23 mm  
180 mm

10-137 70X27 mm  
180 mm

10-134 80X25 mm  
180 mm

10-138 75X30 mm  
180 mm

10-135 100X32 mm  
185 mm

10-139 90X36 mm  
185 mm

10-127 - 131  
KRISTELLER  
10-127 110X18 mm  
10-128 110X20 mm  
10-129 110X27 mm  
10-130 110X30 mm  
10-131 110X36 mm  
220 mm

10-132 - 10-135  
KRISTELLER  
Upper blades

10-136 - 10-139  
KRISTELLER  
Lower blades

# Vaginal Specula



10-140  
60 X 45 mm

10-141  
90 X 45 mm

10-142  
112 X 45 mm

10-140 - 143  
DOYEN  
235 mm

10-143 - 10-153  
DOYEN  
240 mm

width of blades		width of blades	
35 mm	45 mm	35 mm	45 mm
60 mm		60 mm	
length of blades		width of blades	
60 mm	10-143	45 mm	10-146
90 mm	10-144	60 mm	10-150
120 mm	10-145		10-151
160 mm			10-152
			10-153

## Vaginal Retractors



**10-154**  
JOLL (FRIEDMAN)  
155 mm



**10-155**  
RICHTER  
170 mm

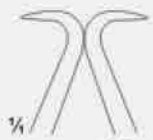

**10-156**  
GELPI  
135 mm

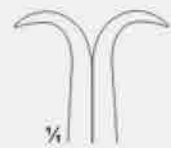

**10-157**  
GELPI  
175 mm



# Uterine Dilators



1/2

**11-101 - 143**  
HEGAR  
with very conical point  
185 mm

11-101	1	mm	11-123	23	mm
11-102	2	mm	11-124	24	mm
11-103	3	mm	11-125	25	mm
11-104	4	mm	11-126	26	mm
11-105	5	mm	11-127	1	1/2mm
11-106	6	mm	11-128	2	1/2mm
11-107	7	mm	11-129	3	1/2mm
11-108	8	mm	11-130	4	1/2mm
11-109	9	mm	11-131	5	1/2mm
11-110	10	mm	11-132	6	1/2mm
11-111	11	mm	11-133	7	1/2mm
11-112	12	mm	11-134	8	1/2mm
11-113	13	mm	11-135	9	1/2mm
11-114	14	mm	11-136	10	1/2mm
11-115	15	mm	11-137	11	1/2mm
11-116	16	mm	11-138	12	1/2mm
11-117	17	mm	11-139	13	1/2mm
11-118	18	mm	11-140	14	1/2mm
11-119	19	mm	11-141	15	1/2mm
11-120	20	mm	11-142	16	1/2mm
11-121	21	mm	11-143	17	1/2mm
11-122	22	mm			



1/2

**11-144 - 152**  
HEGAR  
205 mm

11-144	1+2	mm
11-145	3+4	mm
11-146	5+6	mm
11-147	7+8	mm
11-148	9+10	mm
11-149	11+12	mm
11-150	13+14	mm
11-151	15+16	mm
11-152	17+18	mm

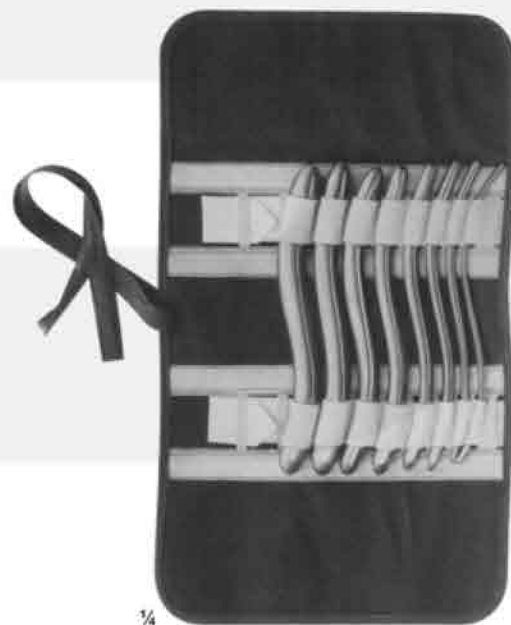

1/4

**11-153**  
HEGAR  
Uterine dilator set, in canvas  
roll with 8 dilators.

## Uterine Probes

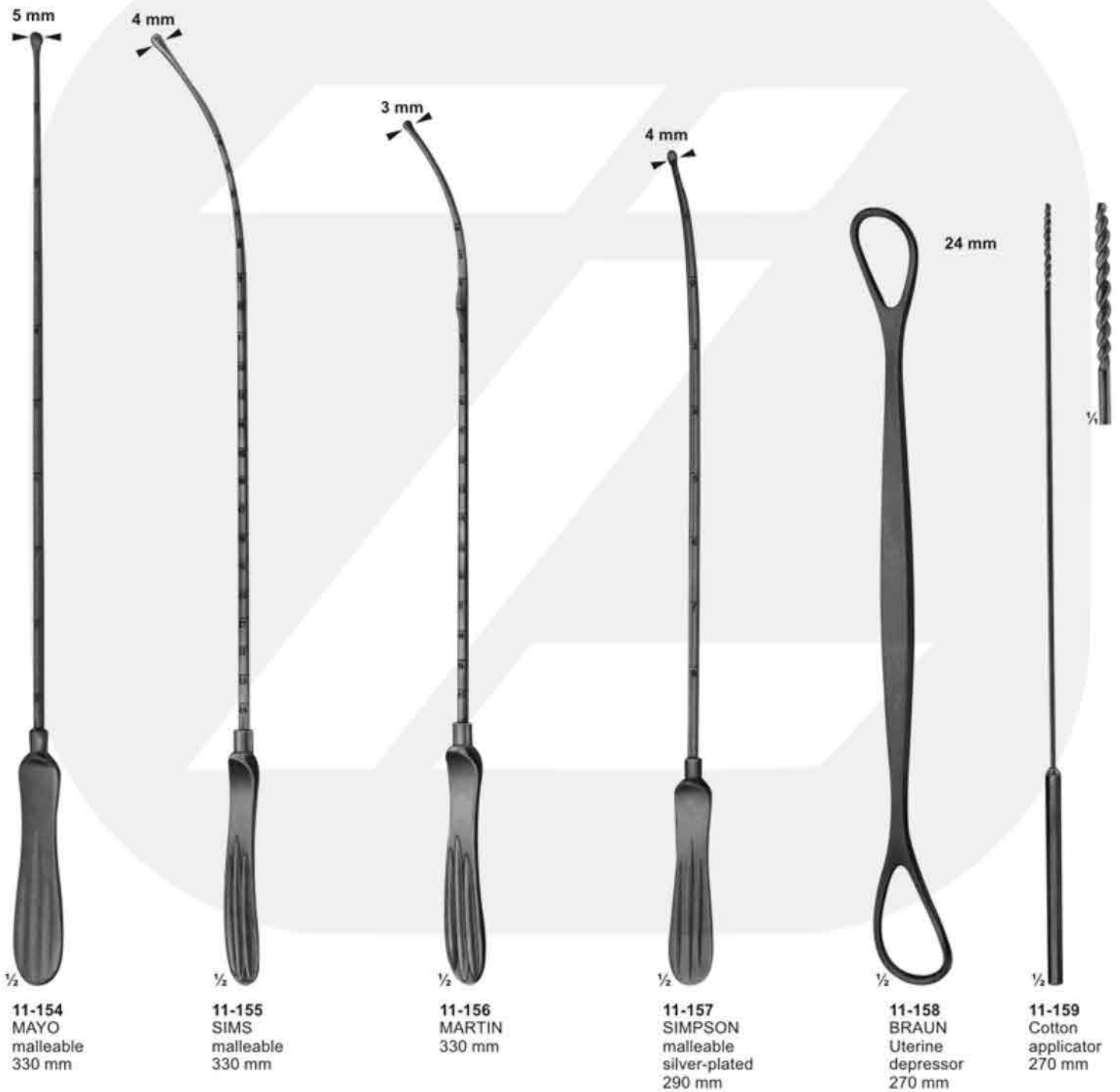

## Uterine Dressing Forceps

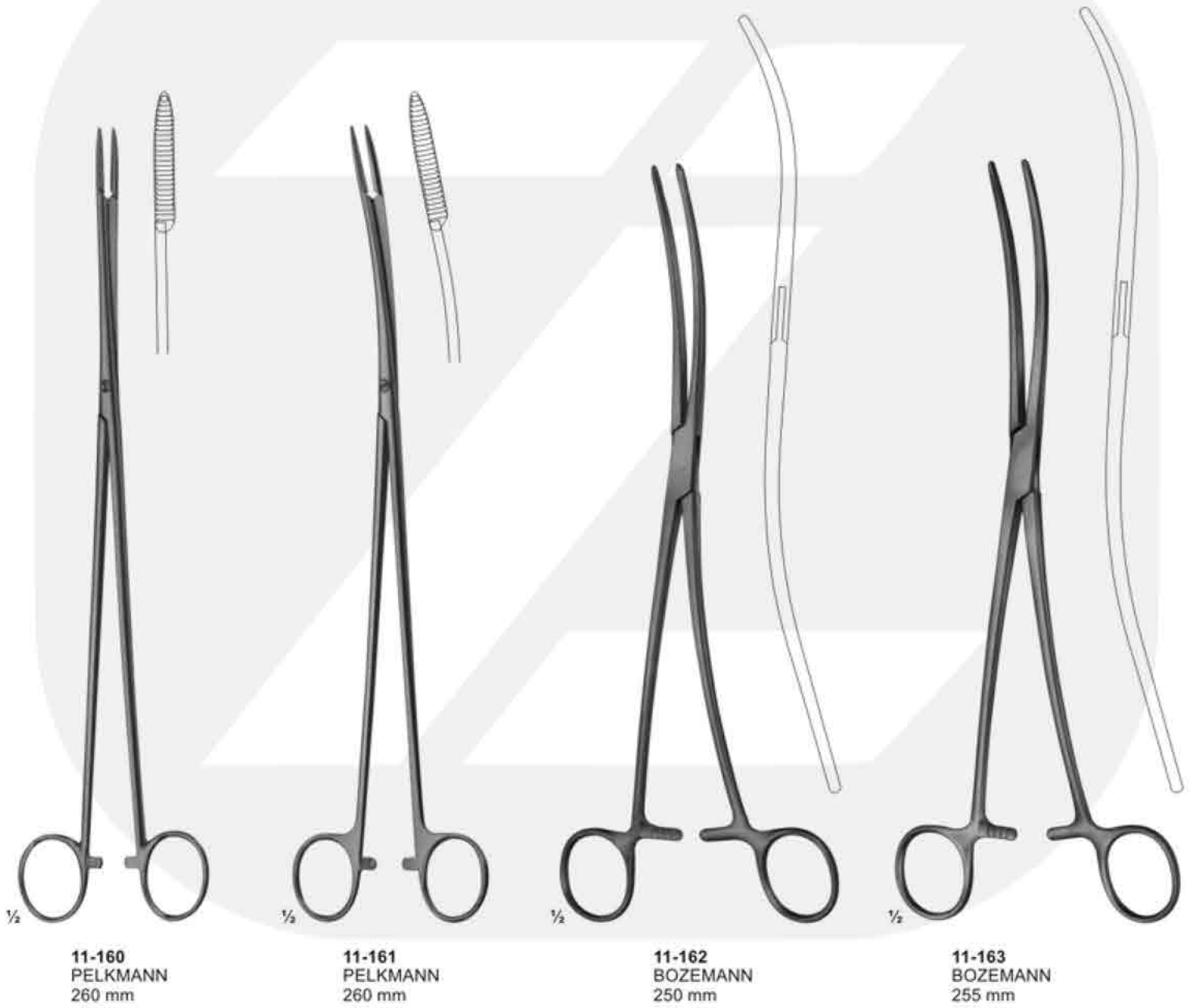

Jaws with longitudinal groove

## Polypus-and Ovum Forceps



**11-164**  
HEYWOOD-SMITH  
200 mm

**11-165**  
KELLY  
320 mm

**11-166**  
HEYWOOD-SMITH  
250 mm

**11-167**  
NOTO  
280 mm



# Ear Curettes

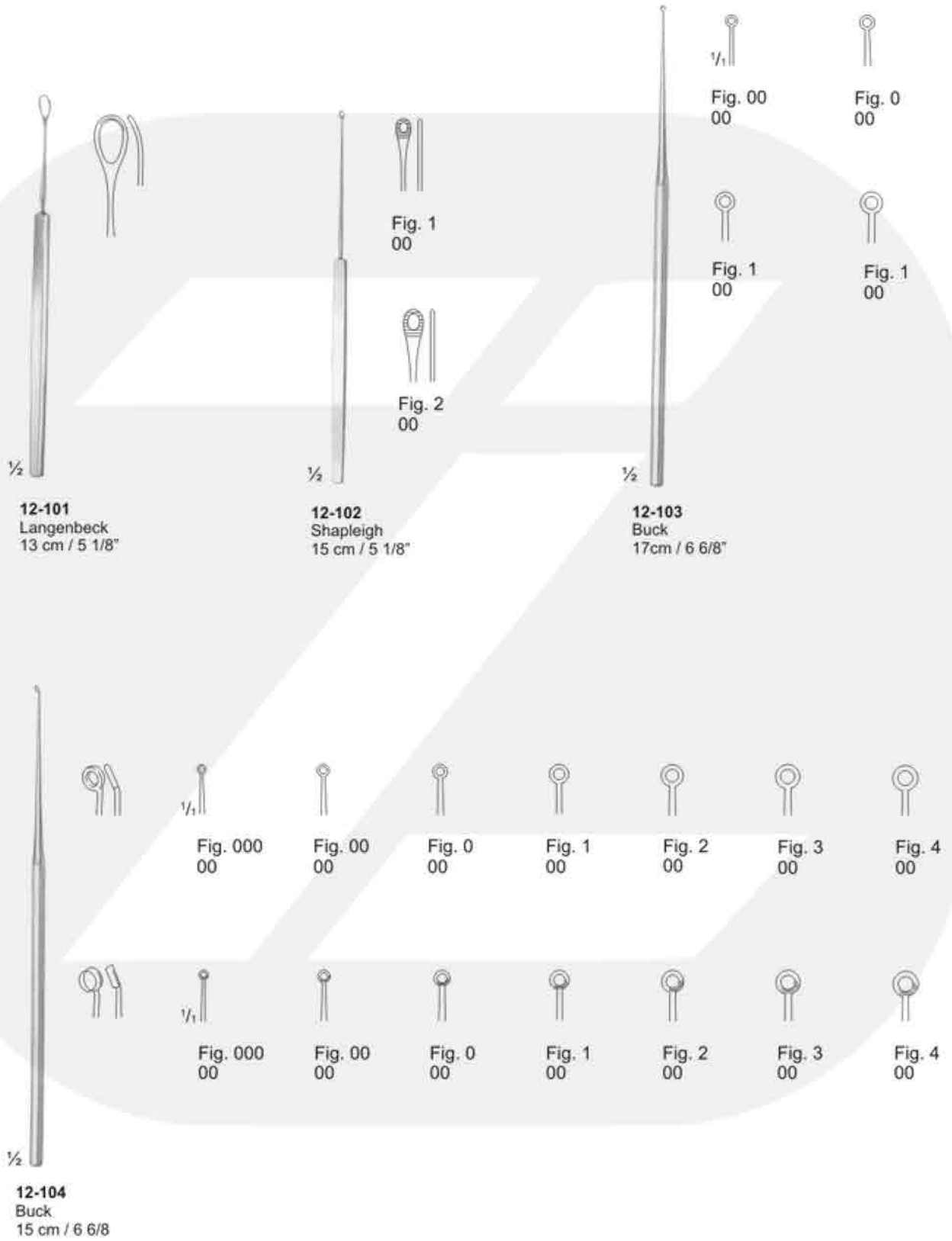

# Biopsy Currettes

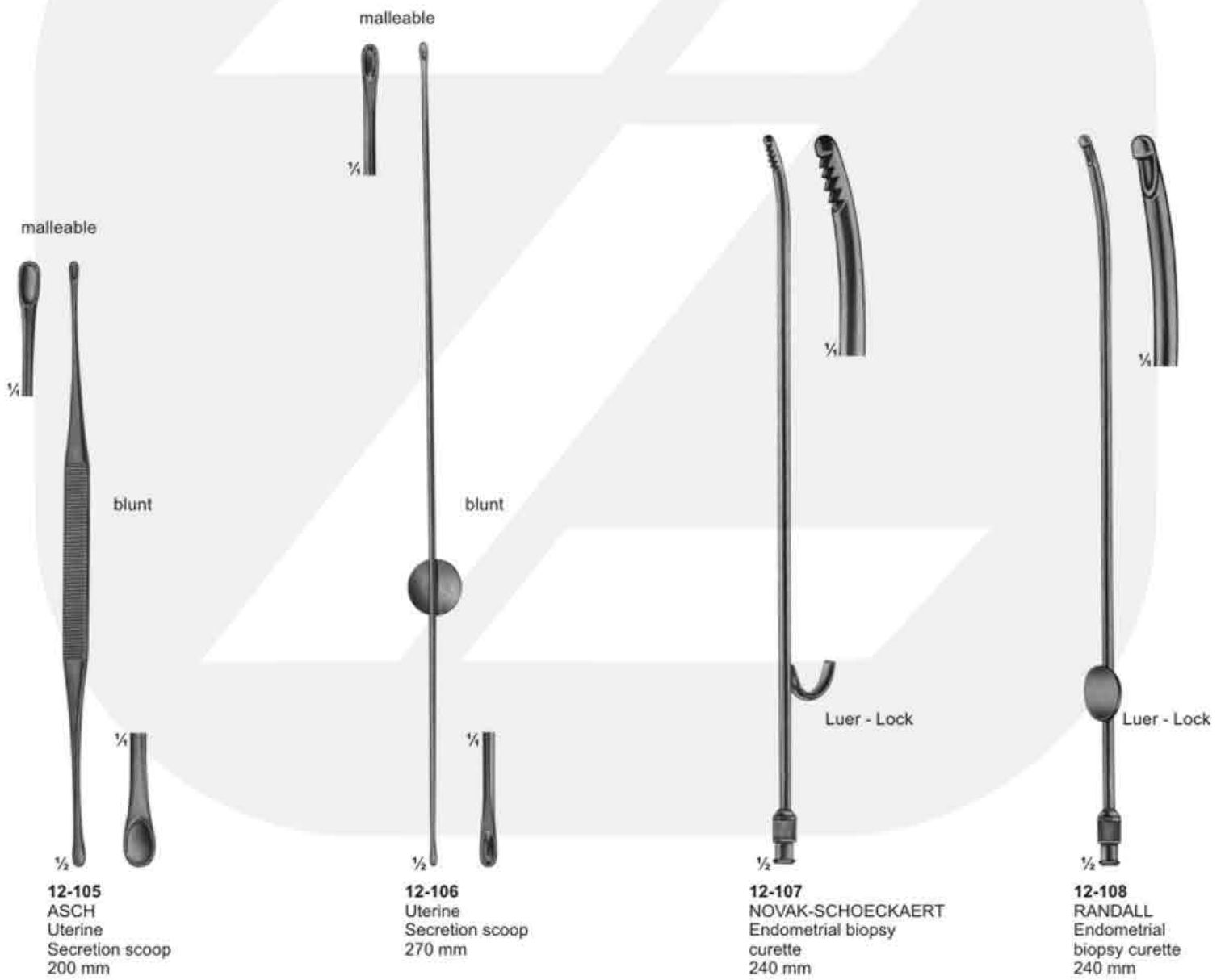

# Ear Polypus Forceps

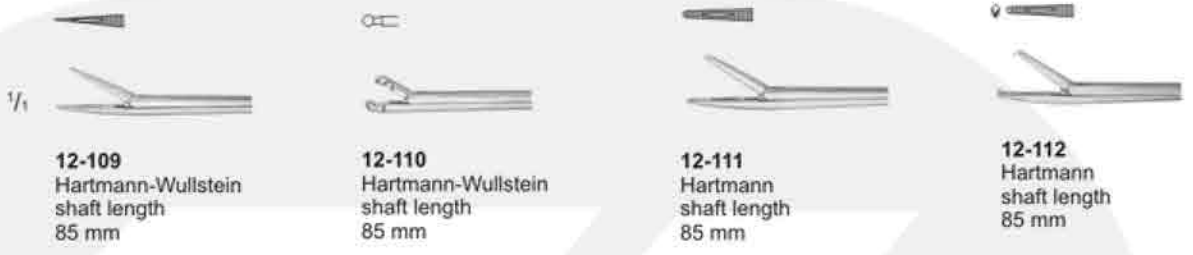

**12-109**  
Hartmann-Wullstein  
shaft length  
85 mm

**12-110**  
Hartmann-Wullstein  
shaft length  
85 mm

**12-111**  
Hartmann  
shaft length  
85 mm

**12-112**  
Hartmann  
shaft length  
85 mm

**12-113**  
14 cm / 5 4/8"  
shaft length  
140 mm



$\frac{1}{2}$   
**12-109 - 12-119**

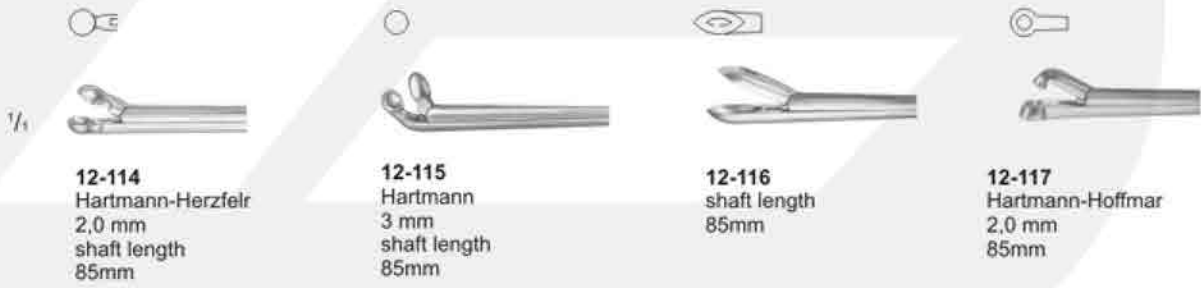

**12-114**  
Hartmann-Herzfelr  
2,0 mm  
shaft length  
85mm

**12-115**  
Hartmann  
3 mm  
shaft length  
85mm

**12-116**  
shaft length  
85mm

**12-117**  
Hartmann-Hoffmar  
2,0 mm  
85mm

**12-118**  
2,5 mm  
85 mm

**12-119**  
3,0 mm  
85 mm

## Biopsy forceps for rectum

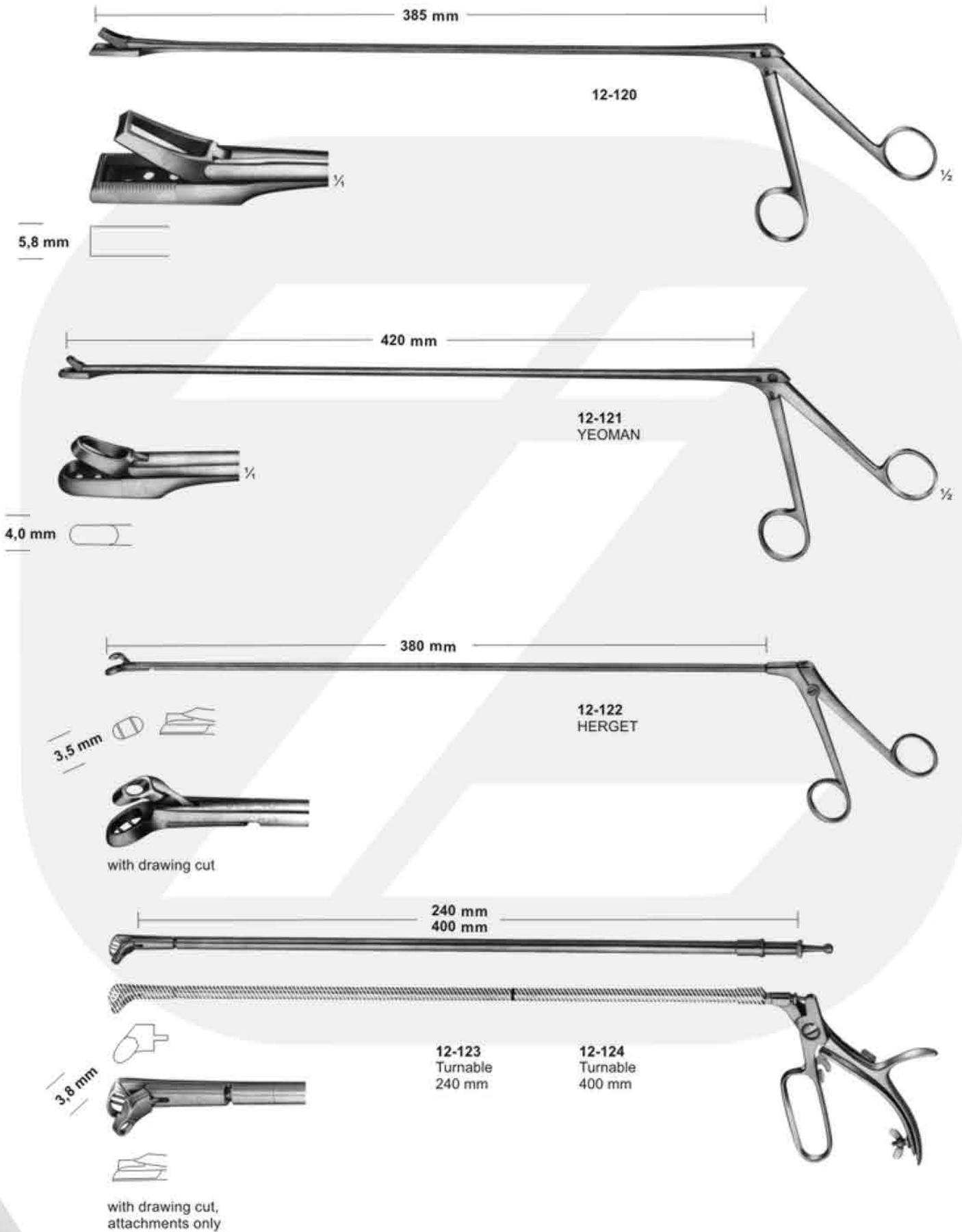



# Biopsy Forceps

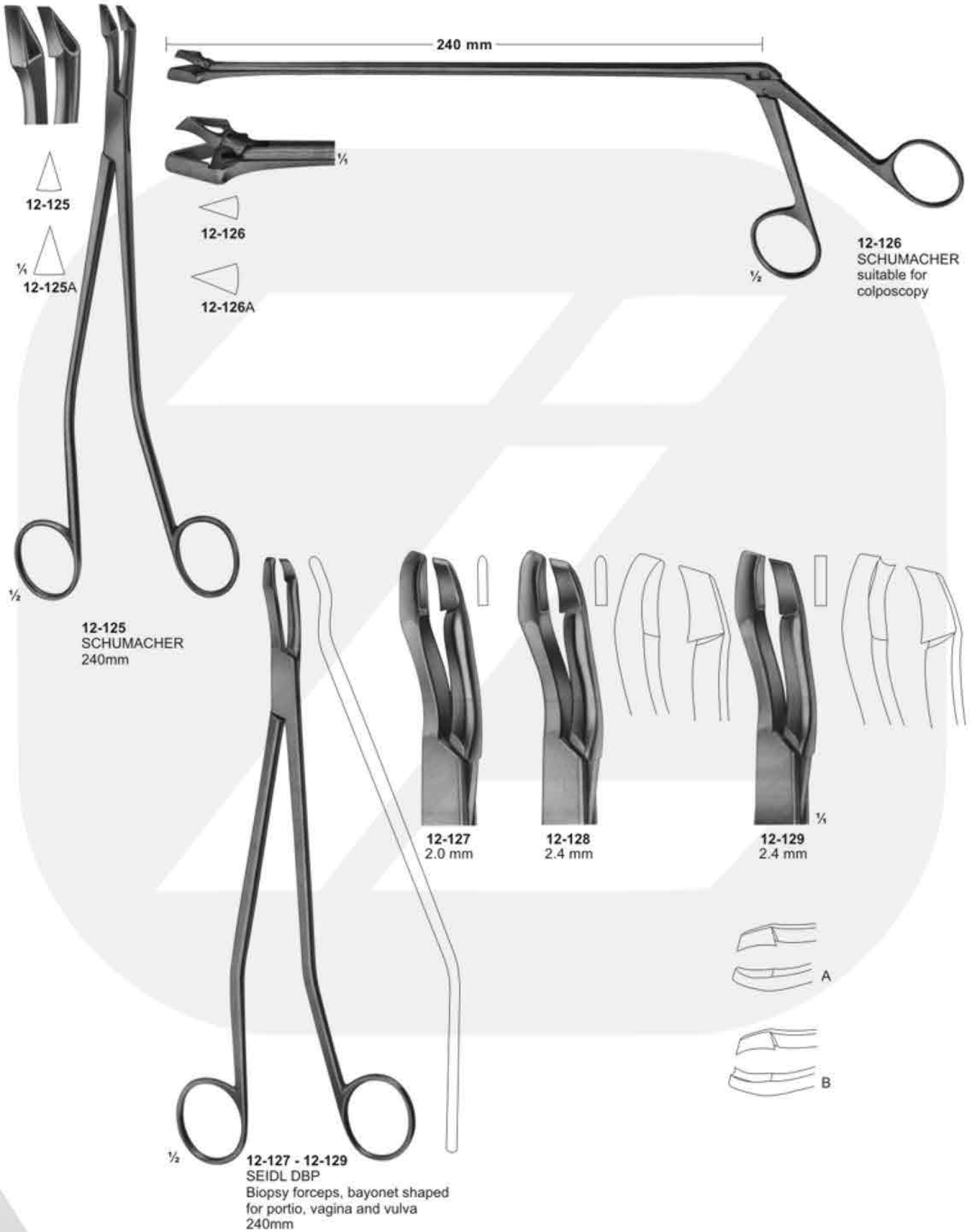

# Biopsy Forceps

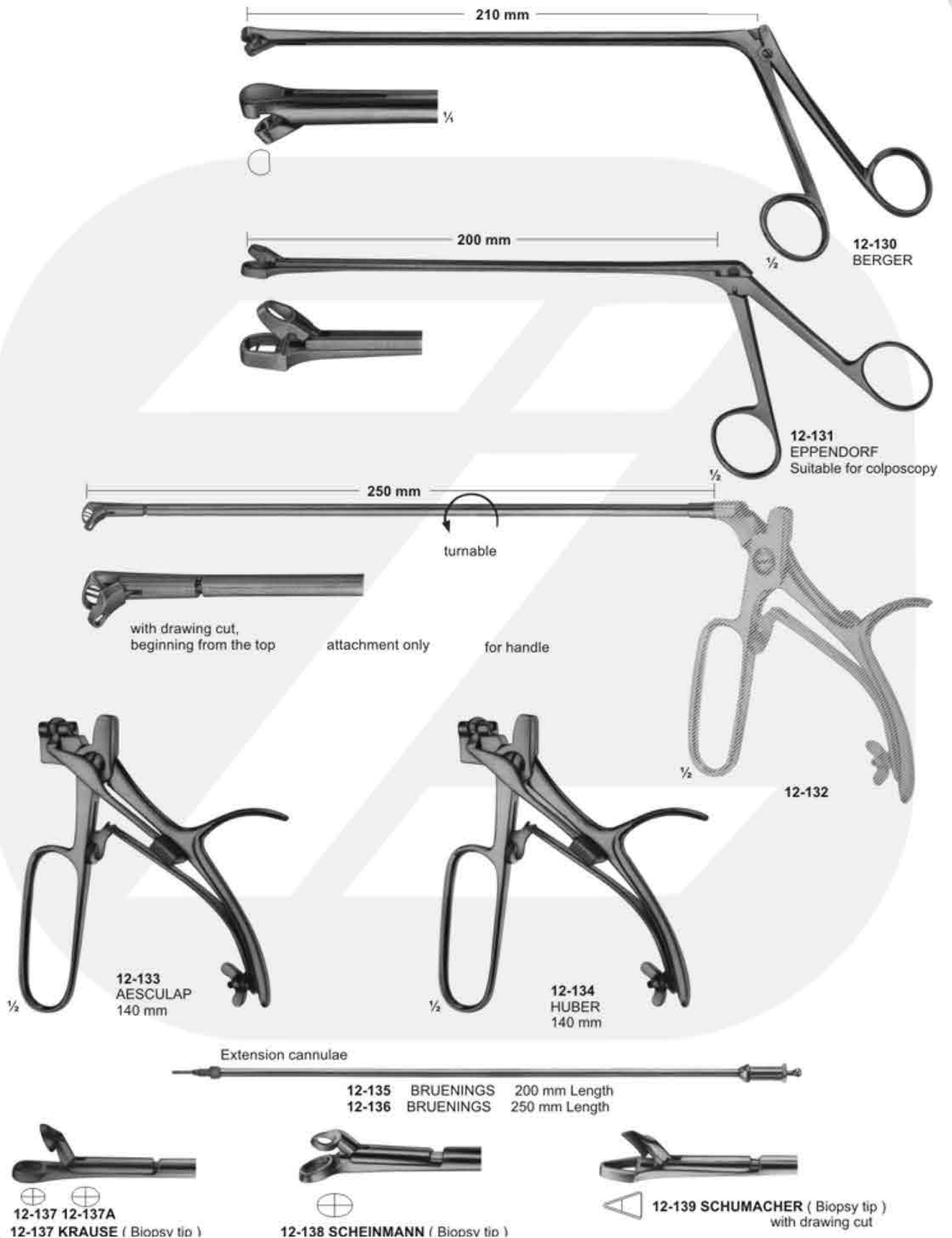

# Uterine Scoops

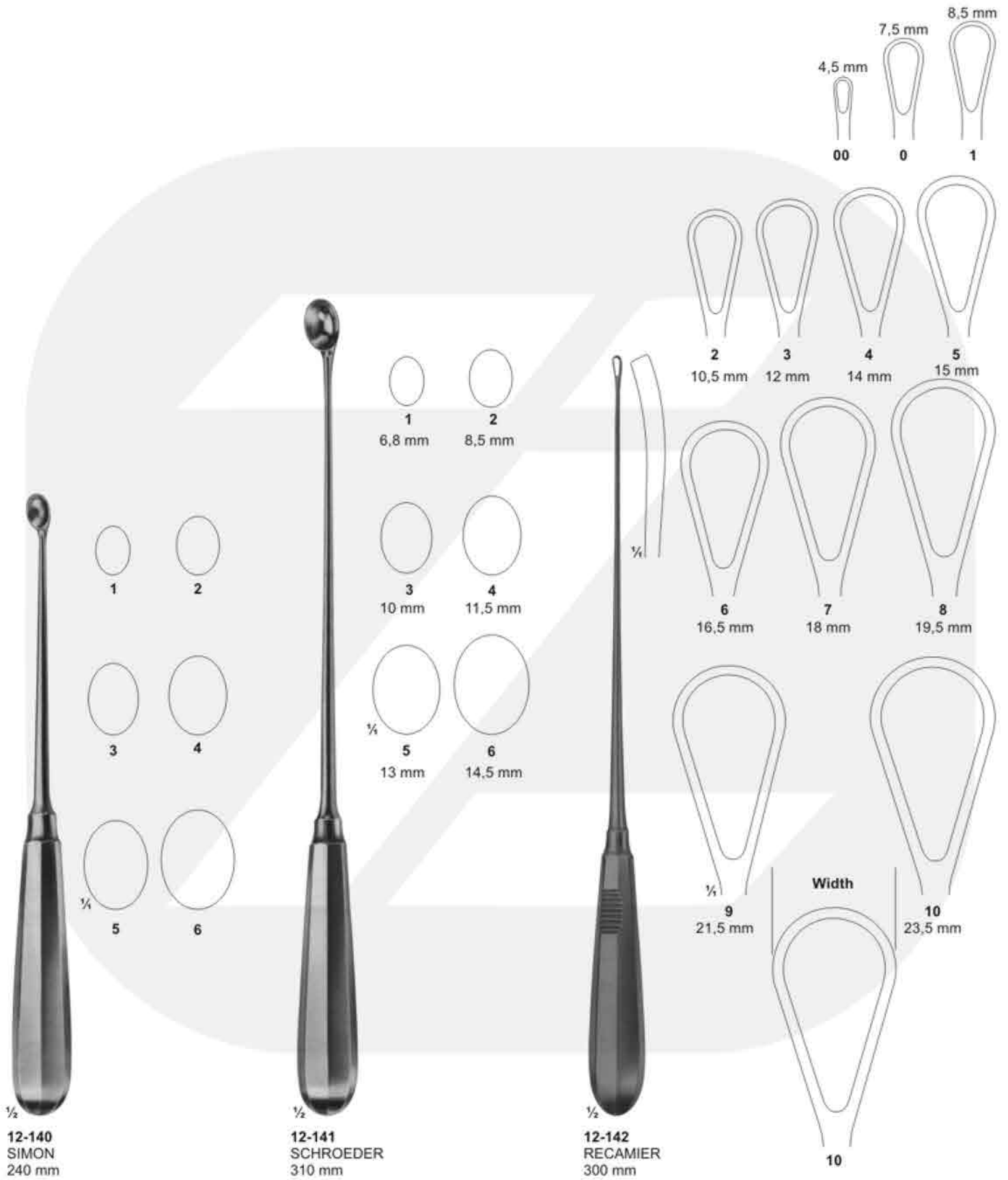

## Obstetrical Forceps



**13-101**  
NAEGELE  
355 mm



**13-102**  
NAEGELE  
400 mm



**13-103**  
SIMPSON-BRAUN  
305mm



## Obstetrics- Placenta and Ovum Forceps



**13-104 - 106**  
WINTER  
290 mm

**13-107 - 109**  
WINTER  
290 mm

**13-110**  
SAENGER  
275 mm

## Tound-and Tracheal Hooks and Dilators

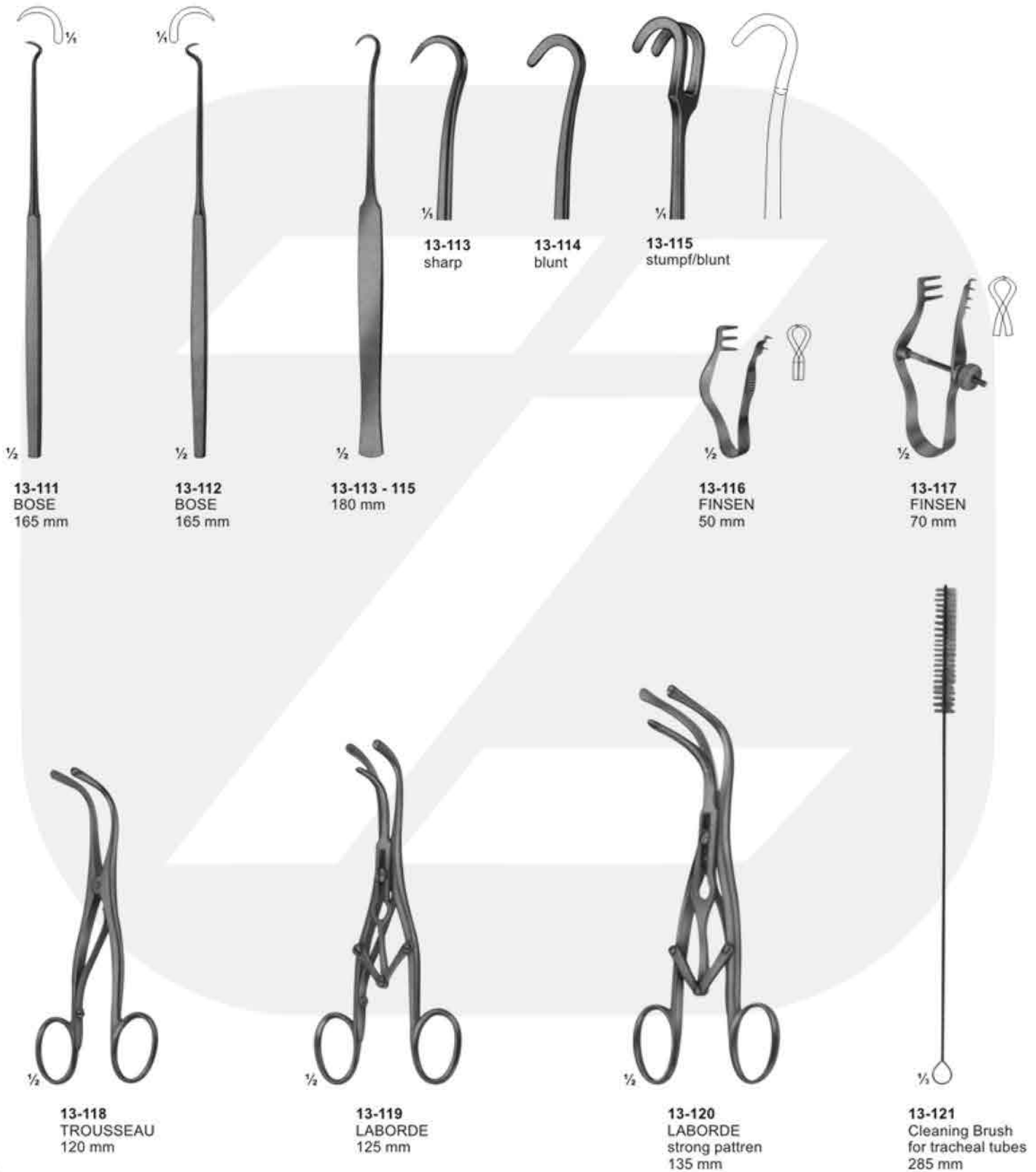

# Vascular Spatulas

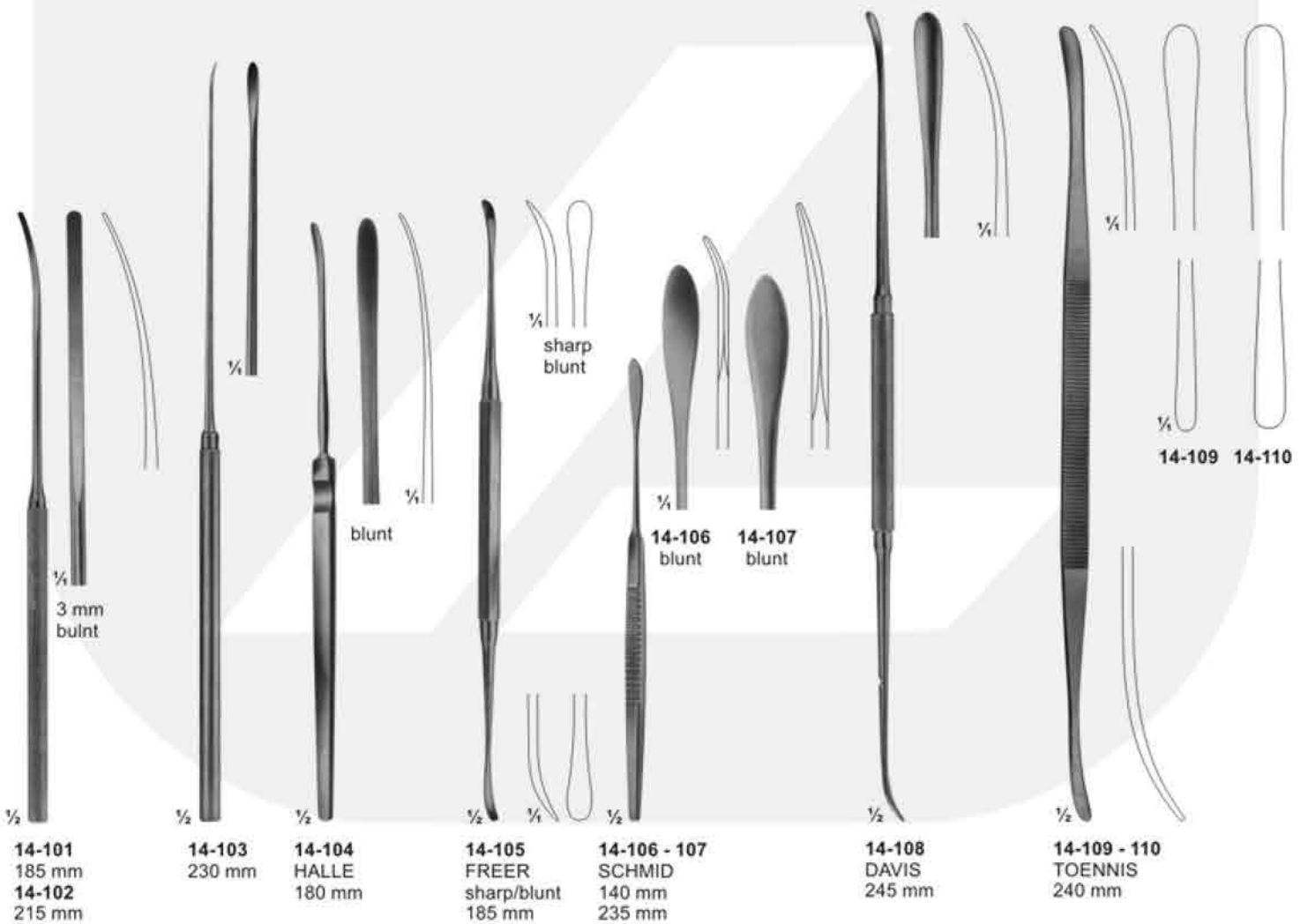

**ATRAUMATA  
Forceps**

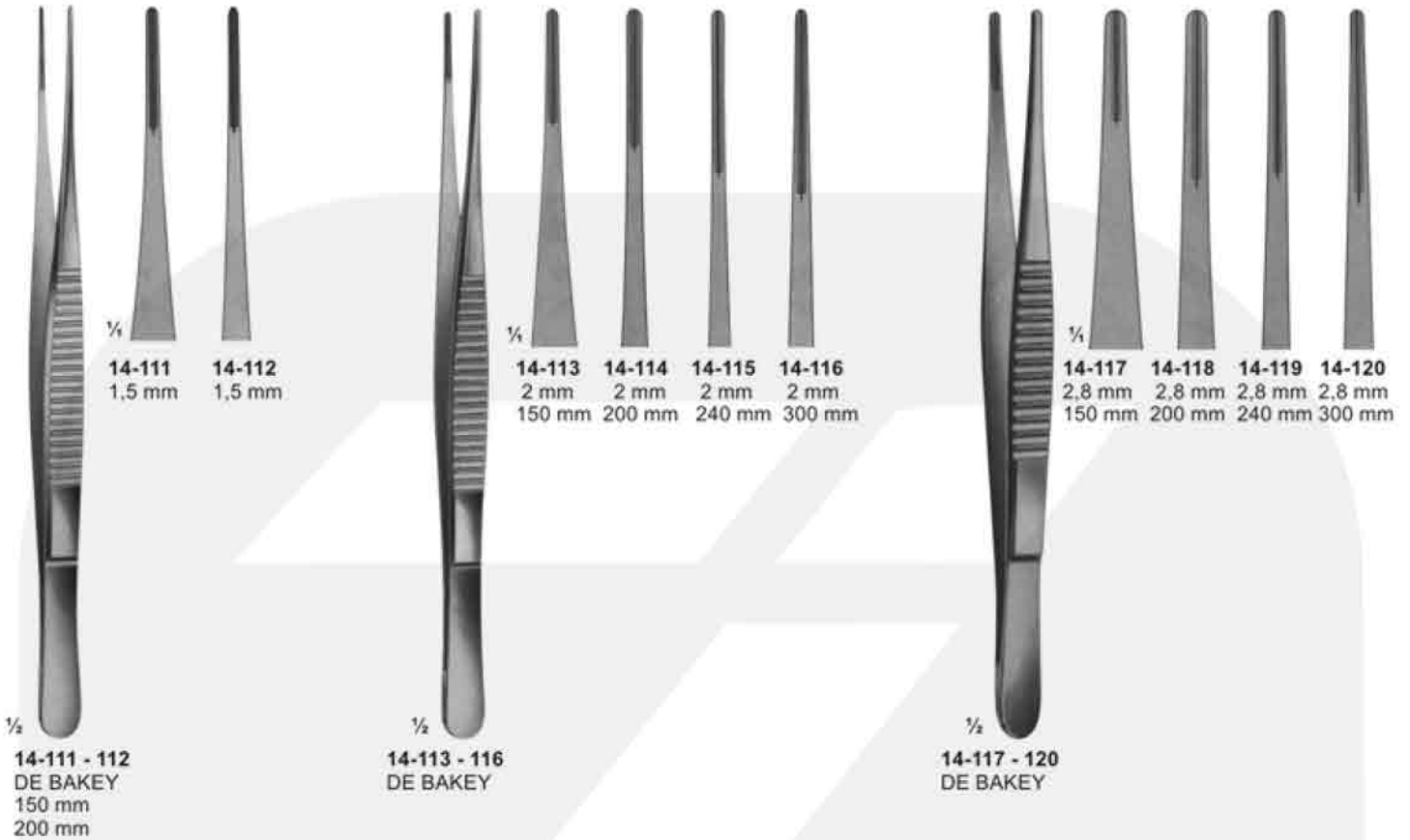



**ATRAUMATA**

**Anastomosis- and Multi- Purpose- Clamps- Pediatric type.**

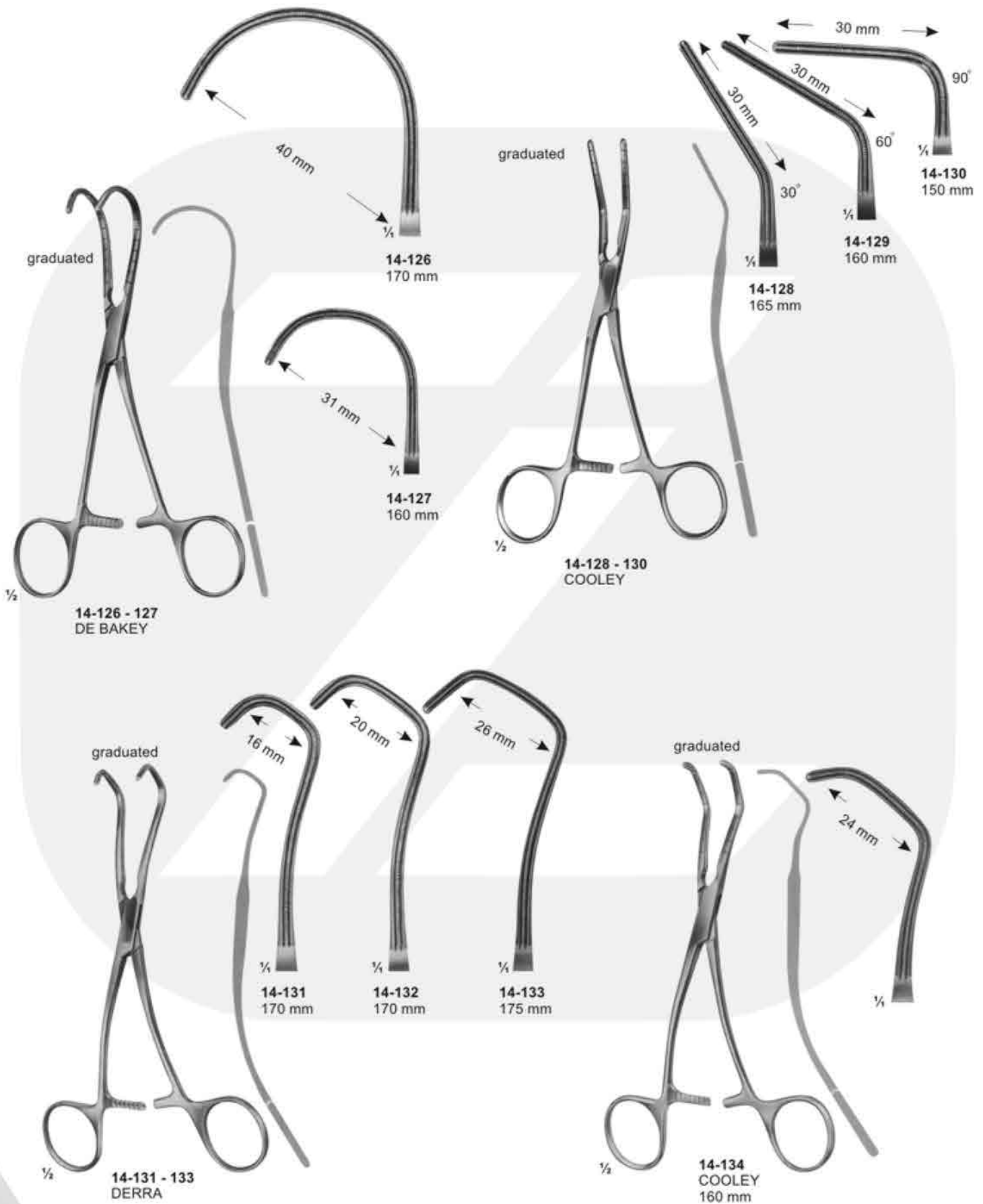

**ATRAUMATA**  
**Coarctation Clamps, Patent-Ductus & Peripheral-Vascular Clamps**

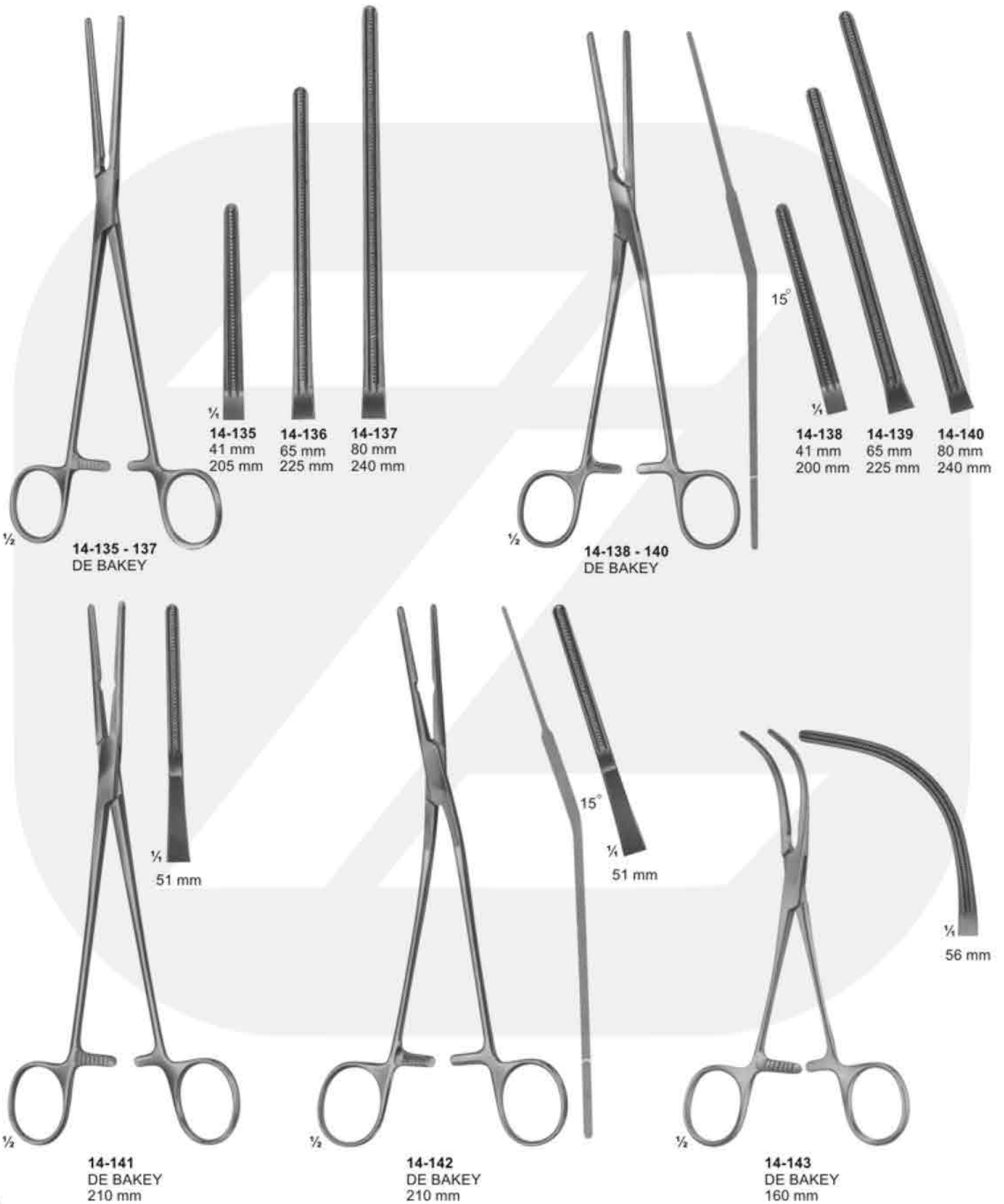

## Aorta- Anastomosis Clamps

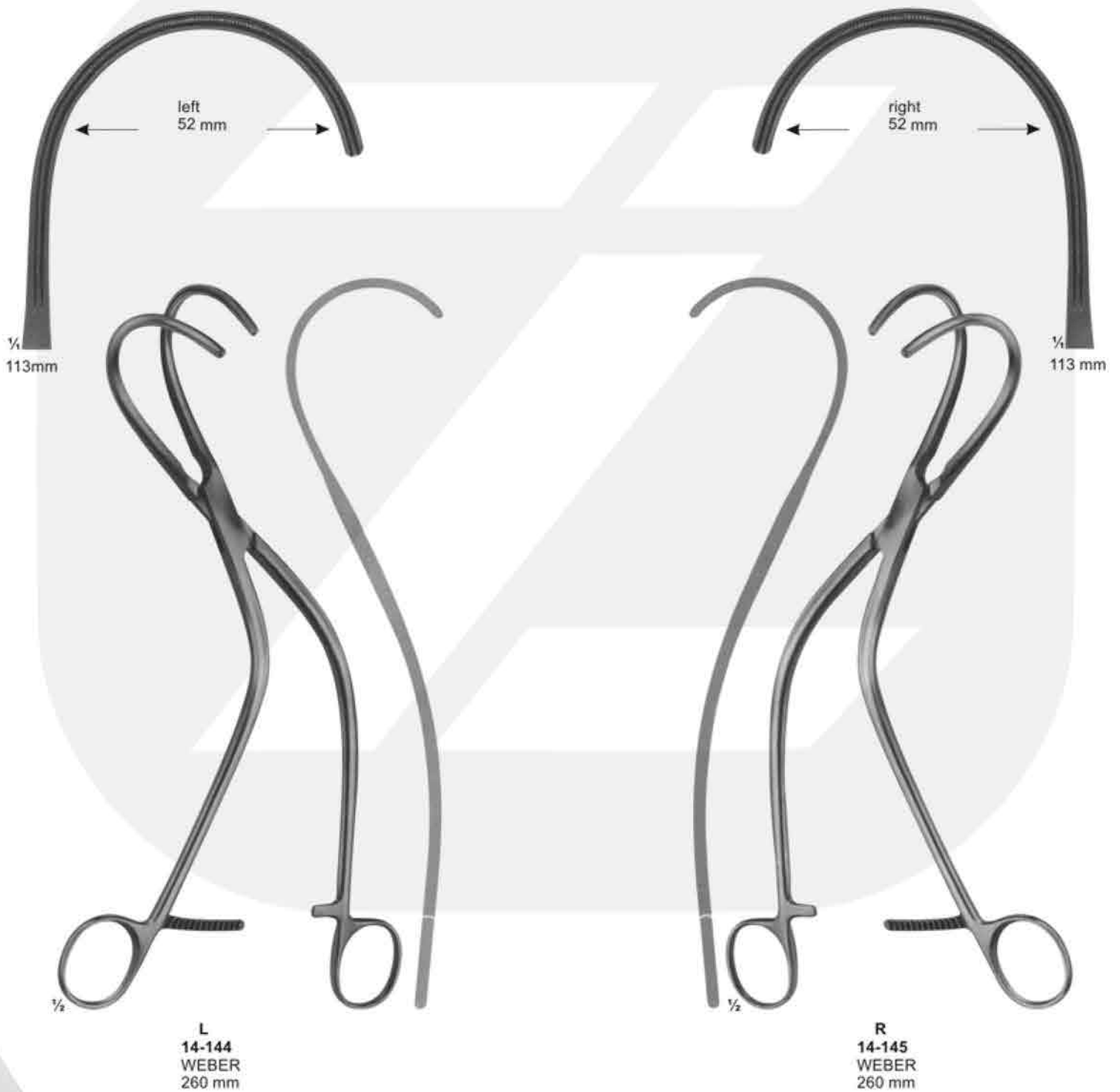

# Multi- Purpose-Clamps



14-146 - 149  
DE BAKEY

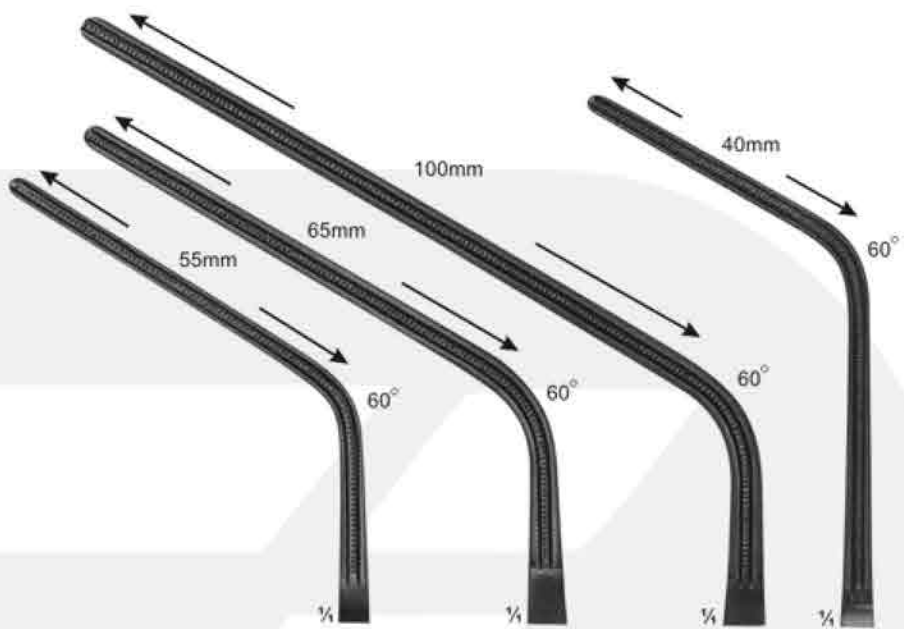

14-146      14-147      14-148      14-149

Total Length:	230 mm	280 mm	305 mm	240 mm
Length of jaws:	85 mm	100 mm	135 mm	93 mm



14-150 - 153  
DE BAKEY

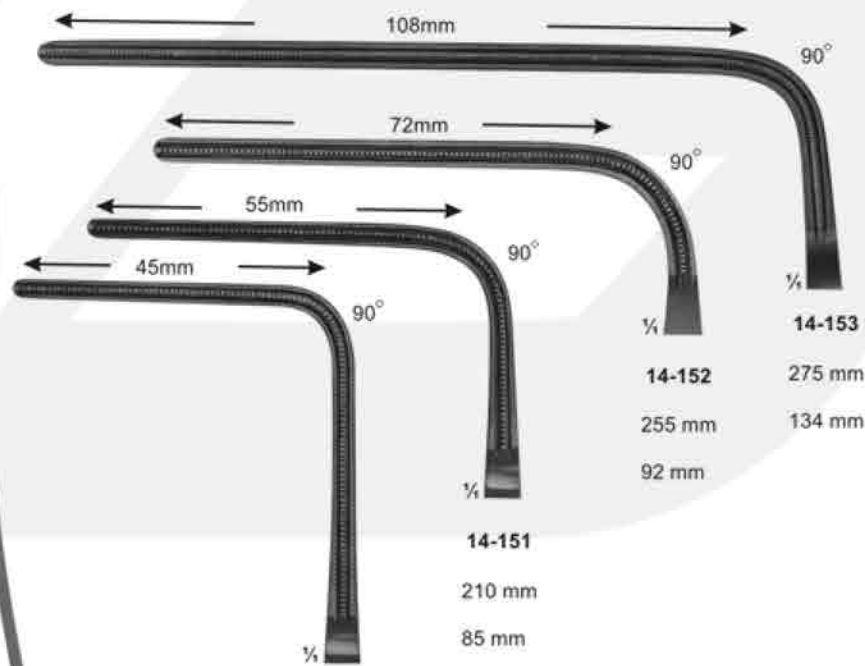

14-150      14-151      14-152      14-153

Total Length:	225 mm	275 mm	255 mm	134 mm
Length of jaws:	93 mm	85 mm	92 mm	



## Sternum Instruments and Rib Shears



14-154  
SCHUMACHER  
Sternum shears  
210 mm



14-155  
LEBSCHÉ  
Sternum chisel  
200 mm



14-156  
230 mm



14-157  
COLLIN  
195 mm



14-158  
GLUCK  
190 mm



14-159  
BETHUNE  
340 mm



14-160  
BRUNNER  
Universal pattern  
340 mm



14-161  
GIERTZ-STILLÉ  
250 mm

## Rib Spreaders



**14-162**  
FINOCHIETTO  
Blades  
18X21 mm

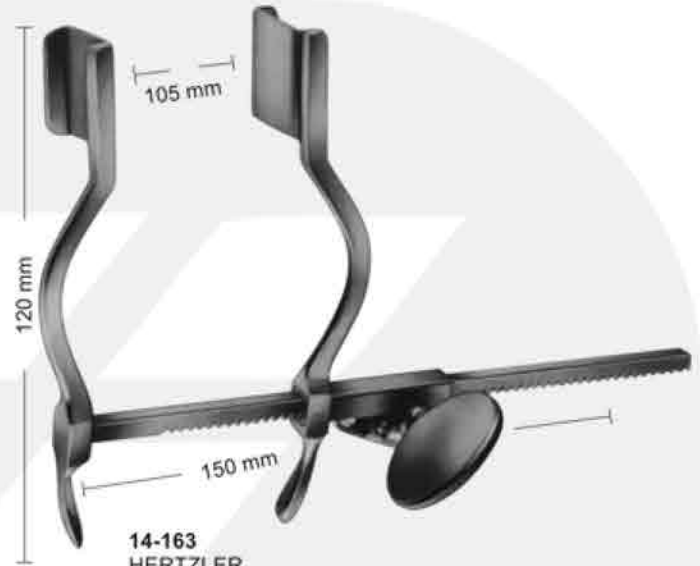

**14-163**  
HERTZLER  
Blades  
20X25 mm



**14-164**  
TUFFIER  
Blades  
43X53 mm

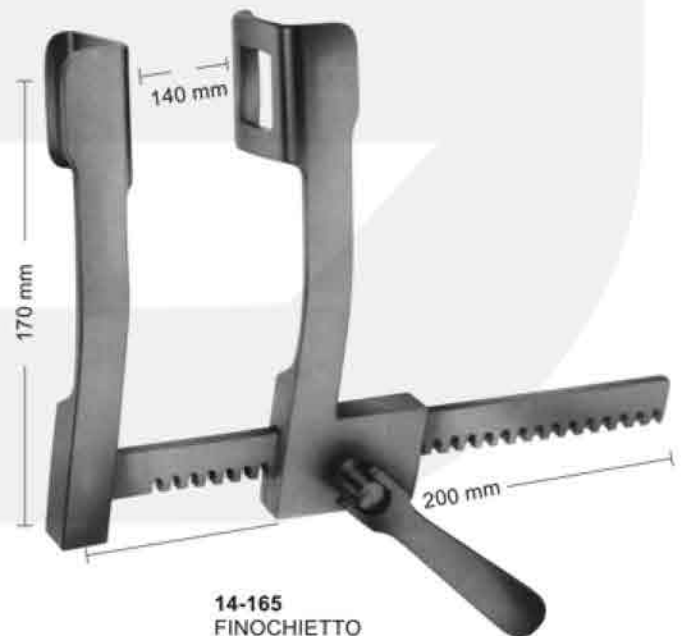

**14-165**  
FINOCHIETTO  
Blades  
36X45 mm

## Rib Spreaders-and Contractors



**14-166**  
**SELLORS**  
Rib spreader-and contractor  
with swivel blades  
200 mm



**14-167**  
**BAILEY**  
150 mm



**14-168**  
for children

**14-169**  
for adults

**14-168 - 169**  
**BAILEY**  
200 mm

# Punches

**130°** upwards cutting

**15-101**  
1 mm



KERRISON - JACOBY

FERRIS-SMITH-KERRISON

**15-102**  
2 mm



**15-103**  
3 mm



**15-104**  
4 mm



**15-105**  
5 mm



180 mm

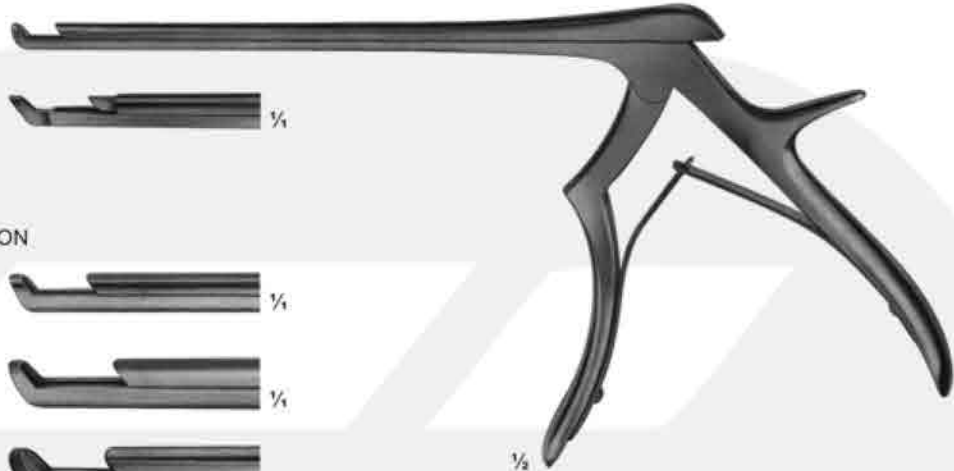

15-101 - 105

**90°** upwards cutting

**15-106**  
1 mm



KERRISON - JACOBY

**15-107**  
2 mm



FERRIS-SMITH-KERRISON

**15-108**  
3 mm



**15-109**  
4 mm



**15-110**  
5 mm



180 mm

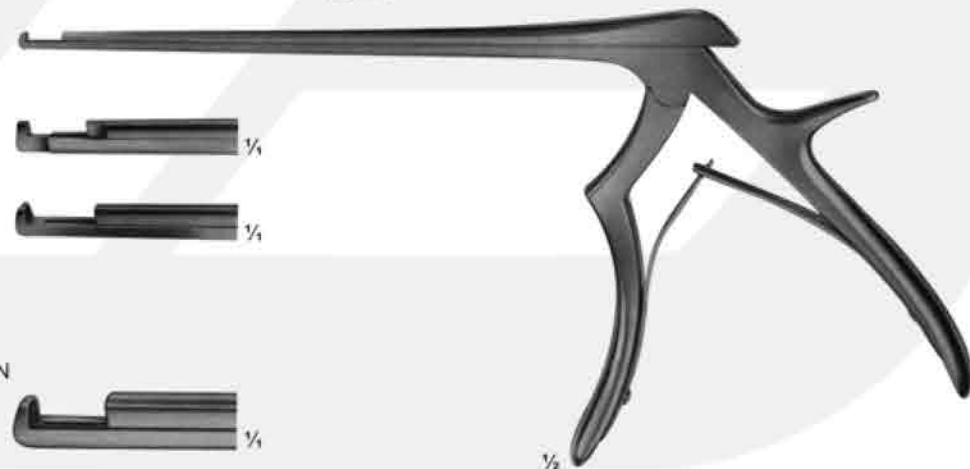

15-106 - 110



# Punches

90° upwards cutting

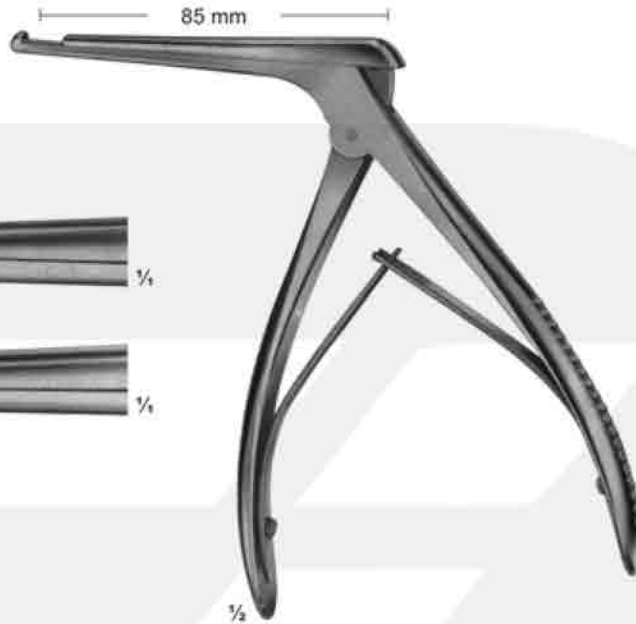

15-111  
4 mm



15-112  
5 mm



15-111 - 15-112  
KERRISON

90° upwards cutting

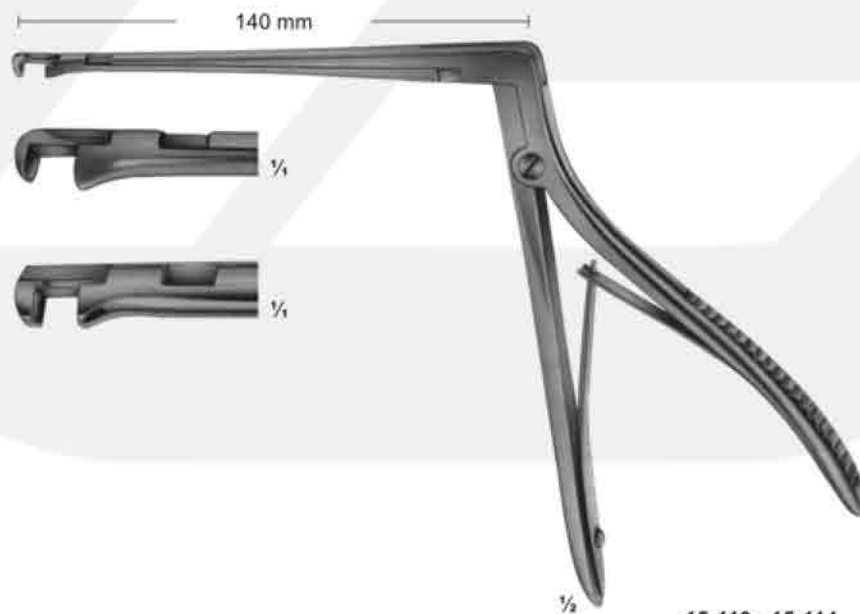

15-113  
3,3 mm



15-114  
4,0 mm



15-113 - 15-114  
HAJEK-KOFLER

# Rongeurs

**LOVE-GRUENWALD**

**15-115**  
2 X 10 mm



**15-116**  
3 X 10 mm



**SPURLING**

**15-117**  
4 X 10 mm



130 mm



15-115 - 15-117

**15-118**  
2 mm



**15-119**  
3 mm



**15-120**  
4 mm



**15-121**  
5 mm



155 mm



15-118 - 15-121  
CASPAR

150°

**15-122**  
2 mm



**15-123**  
3 mm



**15-124**  
4 mm



155 mm



15-122 - 15-124  
CASPAR

# Rongeurs

Angled positions for rongeurs

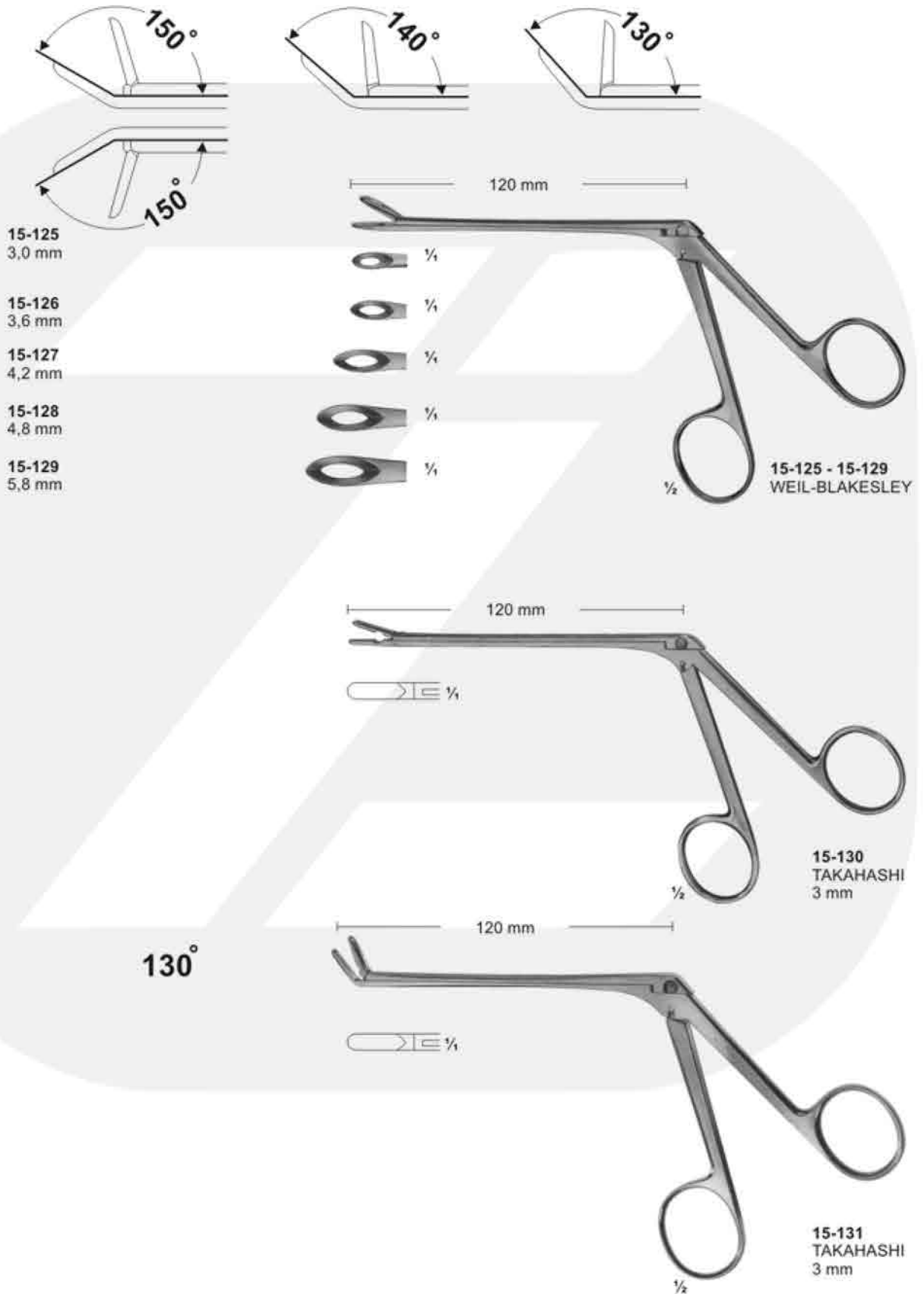

# Rongeurs

**150°**

Lower part of jaws movable

155 mm

**15-132**  
2 mm



**15-133**  
3 mm



**15-134**  
4 mm



**15-132 - 15-134**  
CASPAR

Length of shaft 140 mm	Length of shaft 160 mm	Length of shaft 185 mm	size of jaws
<b>15-135</b>	<b>15-140</b>	<b>15-145</b>	2 X12 mm
<b>15-136</b>	<b>15-141</b>	<b>15-146</b>	3 X12 mm
<b>15-137</b>	<b>15-142</b>	<b>15-147</b>	4 X14 mm
<b>15-138</b>	<b>15-143</b>	<b>15-148</b>	5 X14 mm
<b>15-139</b>	<b>15-144</b>	<b>15-149</b>	6 X16 mm



**15-135 - 15-149**  
CASPAR

**150°**

Length of shaft 140 mm	Length of shaft 160 mm	Length of shaft 185 mm	size of jaws
<b>15-150</b>	<b>15-153</b>	<b>15-156</b>	3 X12 mm
<b>15-151</b>	<b>15-154</b>	<b>15-157</b>	4 X14 mm
<b>15-152</b>	<b>15-155</b>	<b>15-158</b>	5 X14 mm

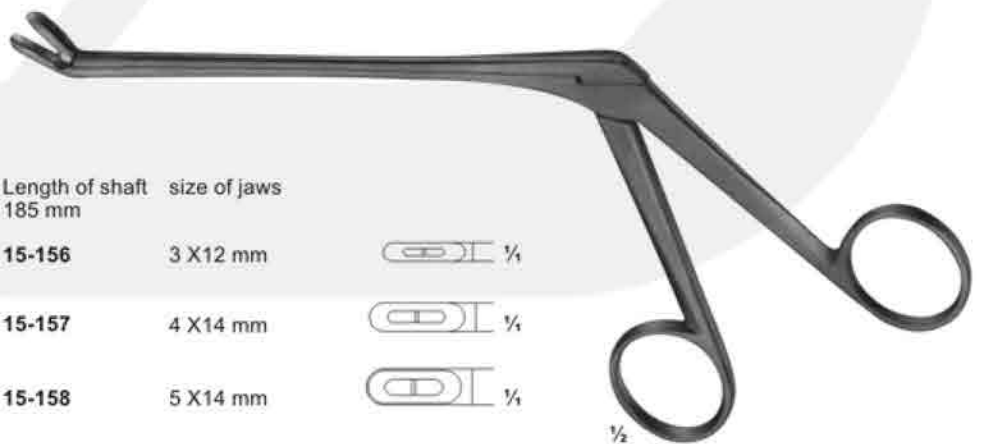

**15-150 - 15-158**  
CASPAR



# Rongeurs

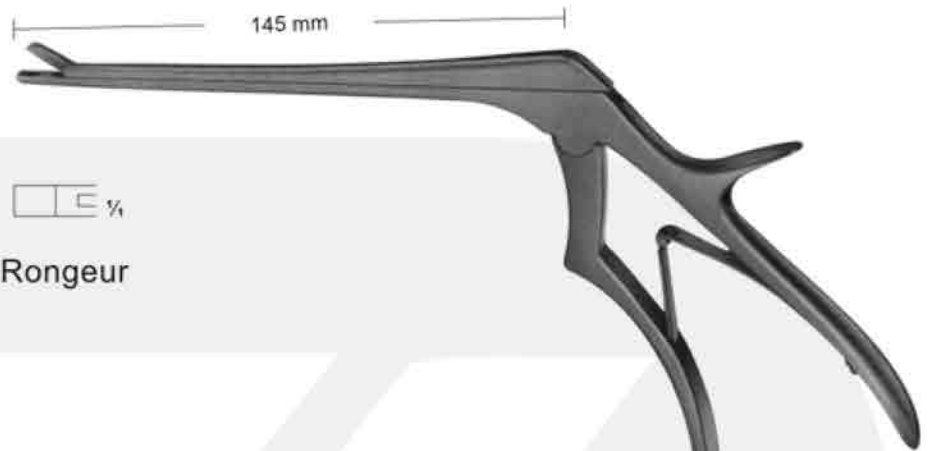

15-159  
4 mm



Osteophyte Rongeur

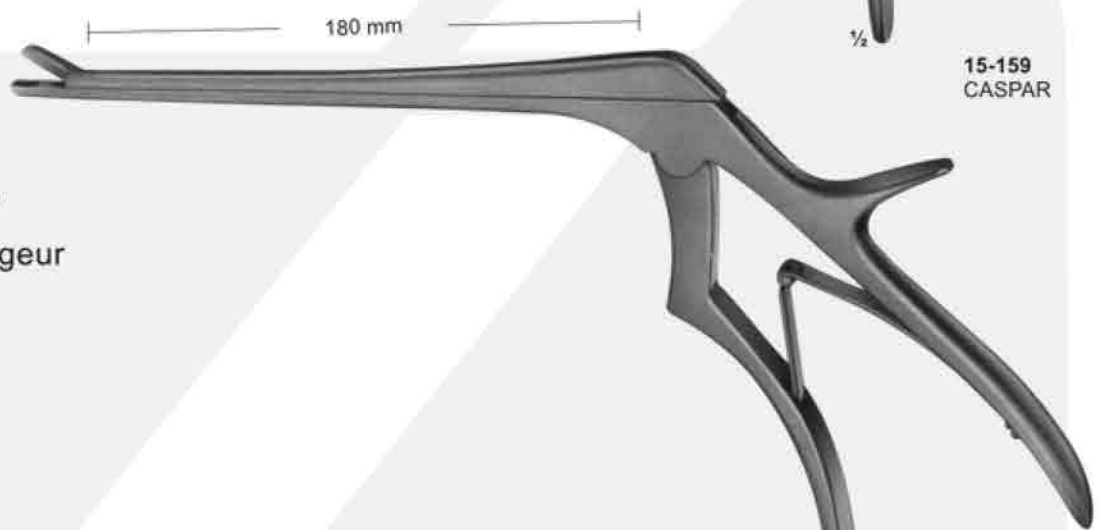

15-160  
4 mm



Osteophyte Rongeur

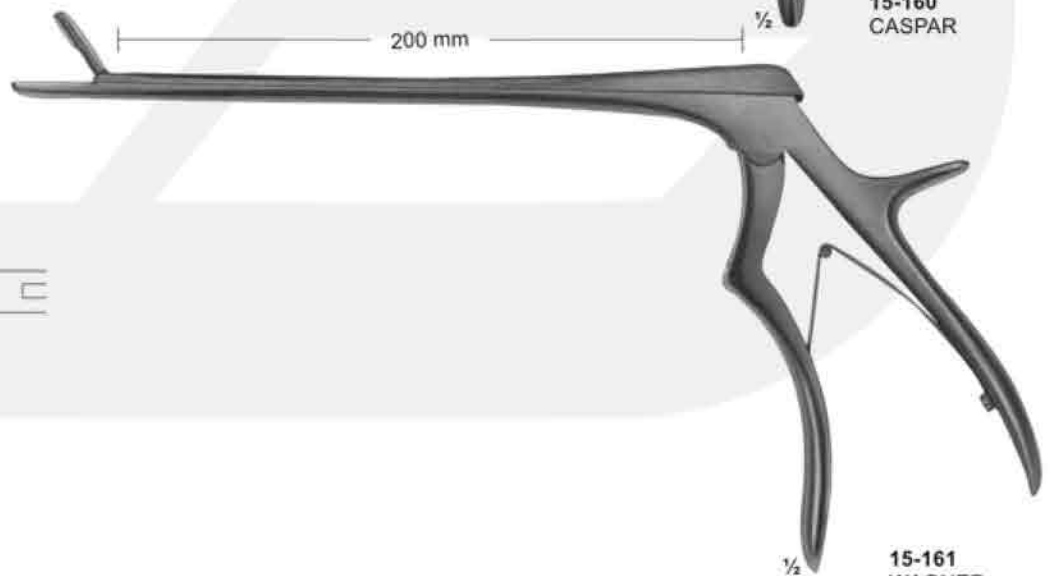

15-161  
5,5 mm



Very Heavy Pattern

1/2  
15-159  
CASPAR

1/2  
15-160  
CASPAR

1/2  
15-161  
WAGNER

## Elevators and Bone Levers

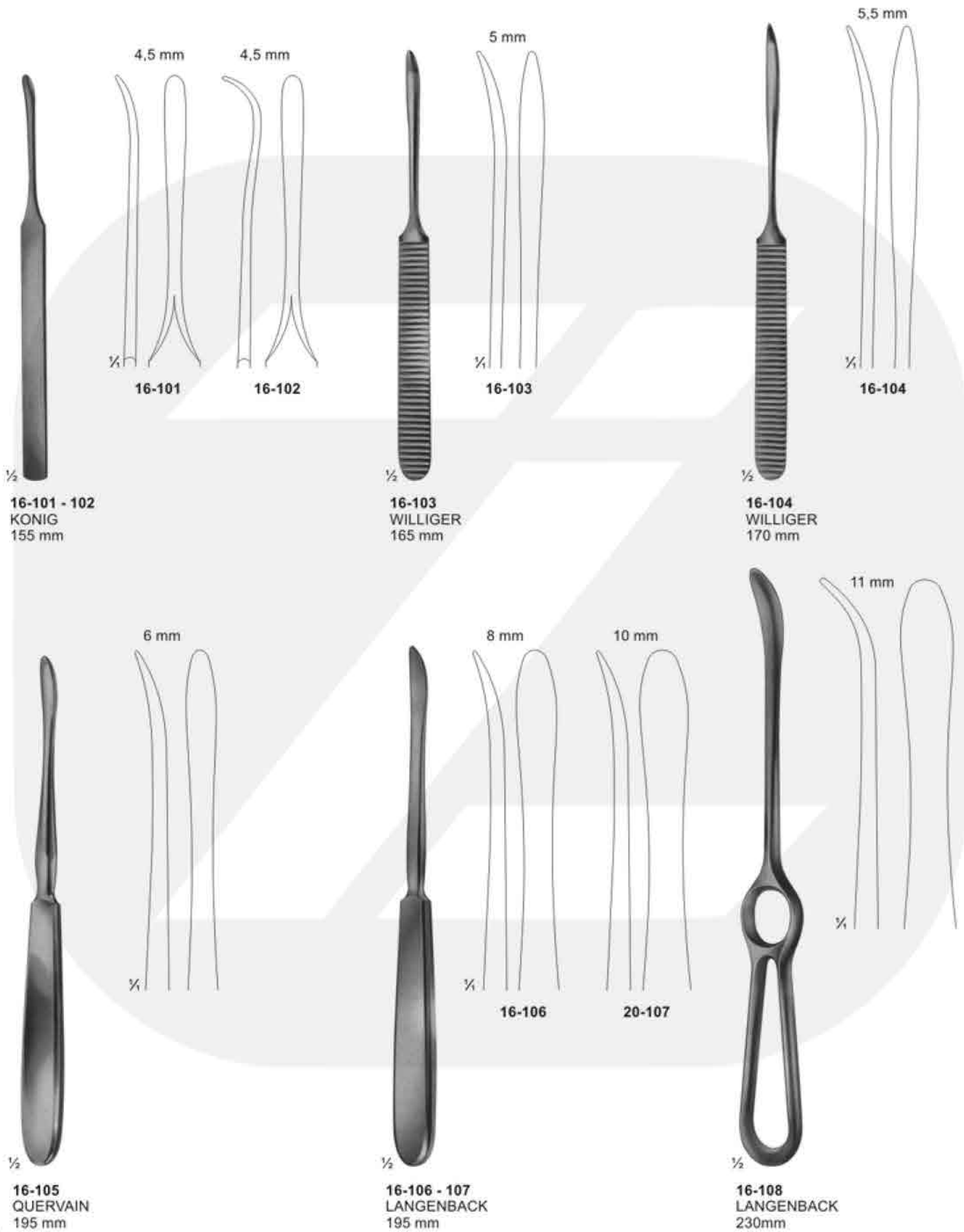



# Raspatories

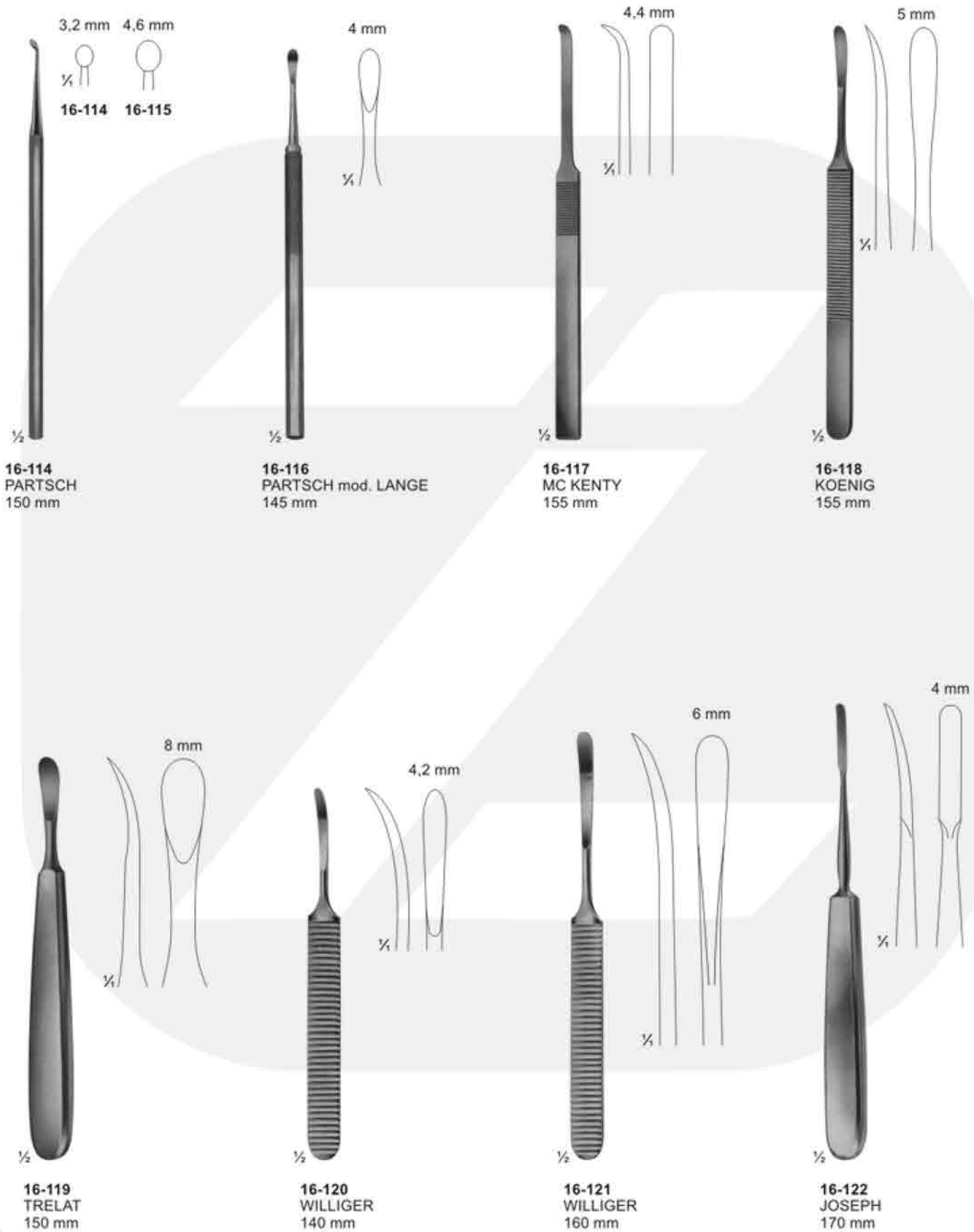

3,2 mm 4,6 mm  
 $\frac{1}{4}$   
**16-114** **16-115**  
 $\frac{1}{2}$

**16-114**  
PARTSCH  
150 mm

4 mm  
 $\frac{1}{4}$   
 $\frac{1}{2}$

**16-116**  
PARTSCH mod. LANGE  
145 mm

4,4 mm  
 $\frac{1}{4}$   
 $\frac{1}{2}$

**16-117**  
MC KENTY  
155 mm

5 mm  
 $\frac{1}{4}$   
 $\frac{1}{2}$

**16-118**  
KOENIG  
155 mm

8 mm  
 $\frac{1}{4}$   
 $\frac{1}{2}$

**16-119**  
TRELAT  
150 mm

4,2 mm  
 $\frac{1}{4}$   
 $\frac{1}{2}$

**16-120**  
WILLIGER  
140 mm

6 mm  
 $\frac{1}{4}$   
 $\frac{1}{2}$

**16-121**  
WILLIGER  
160 mm

4 mm  
 $\frac{1}{4}$   
 $\frac{1}{2}$

**16-122**  
JOSEPH  
170 mm



## Bone File and Rasps

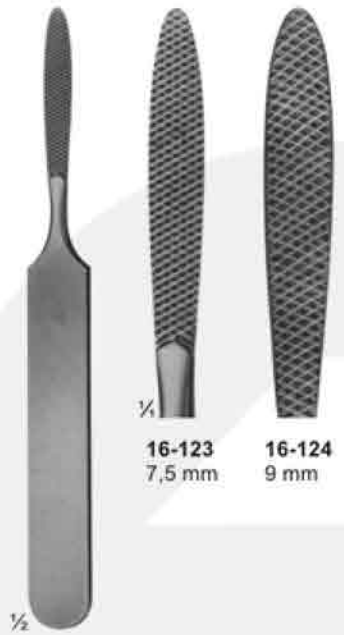
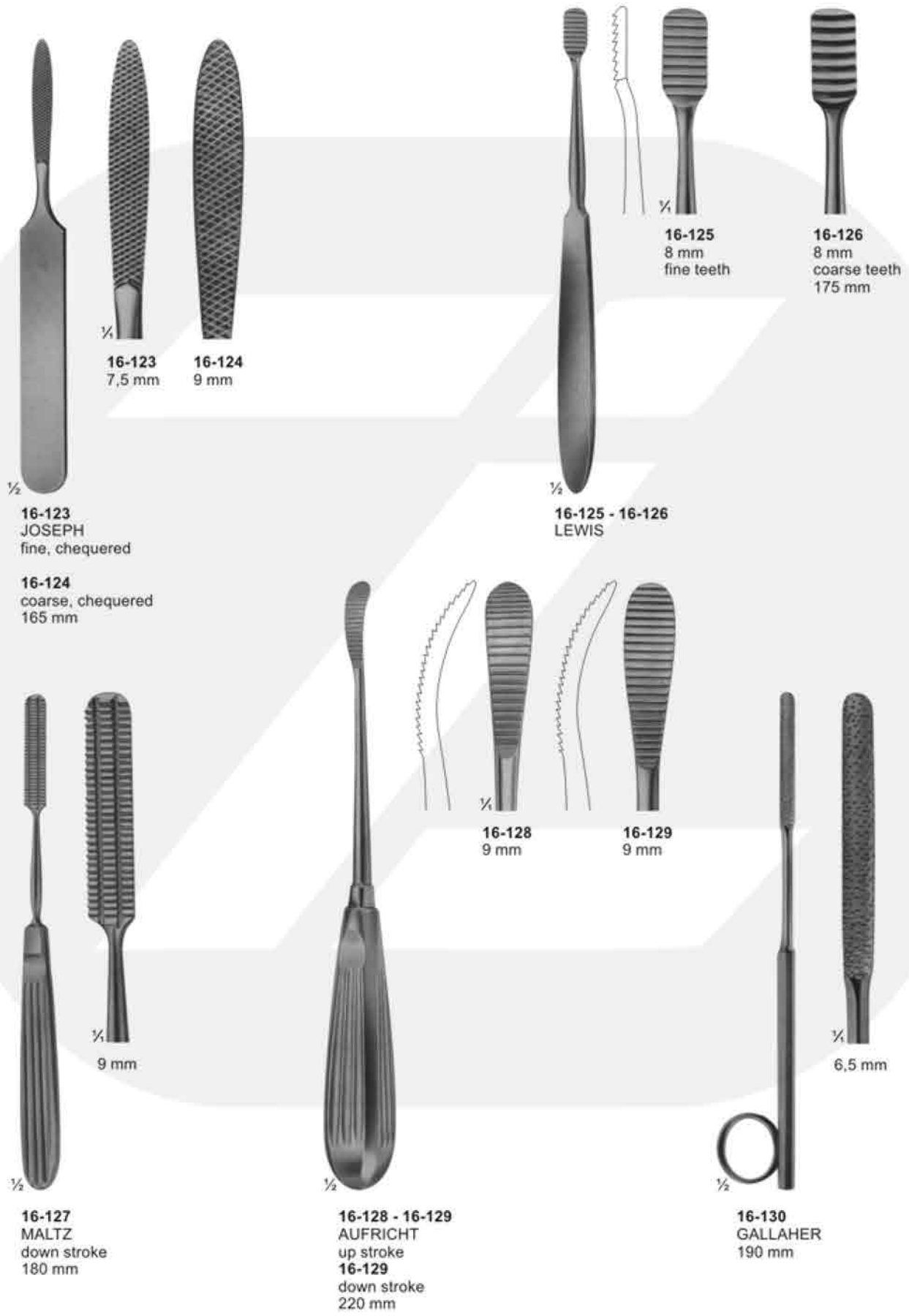

16-123  
7,5 mm

16-124  
9 mm

16-125  
8 mm  
fine teeth

16-126  
8 mm  
coarse teeth  
175 mm

16-123  
JOSEPH  
fine, chequered

16-124  
coarse, chequered  
165 mm

16-125 - 16-126  
LEWIS



16-127  
9 mm

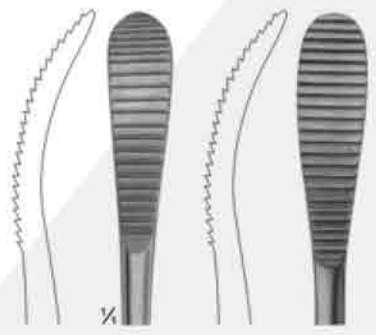

16-128  
9 mm

16-129  
9 mm



16-130  
6,5 mm

16-127  
MALTZ  
down stroke  
180 mm

16-128 - 16-129  
AUFRICHT  
up stroke  
16-129  
down stroke  
220 mm

16-130  
GALLAHER  
190 mm

## Bone Currettes

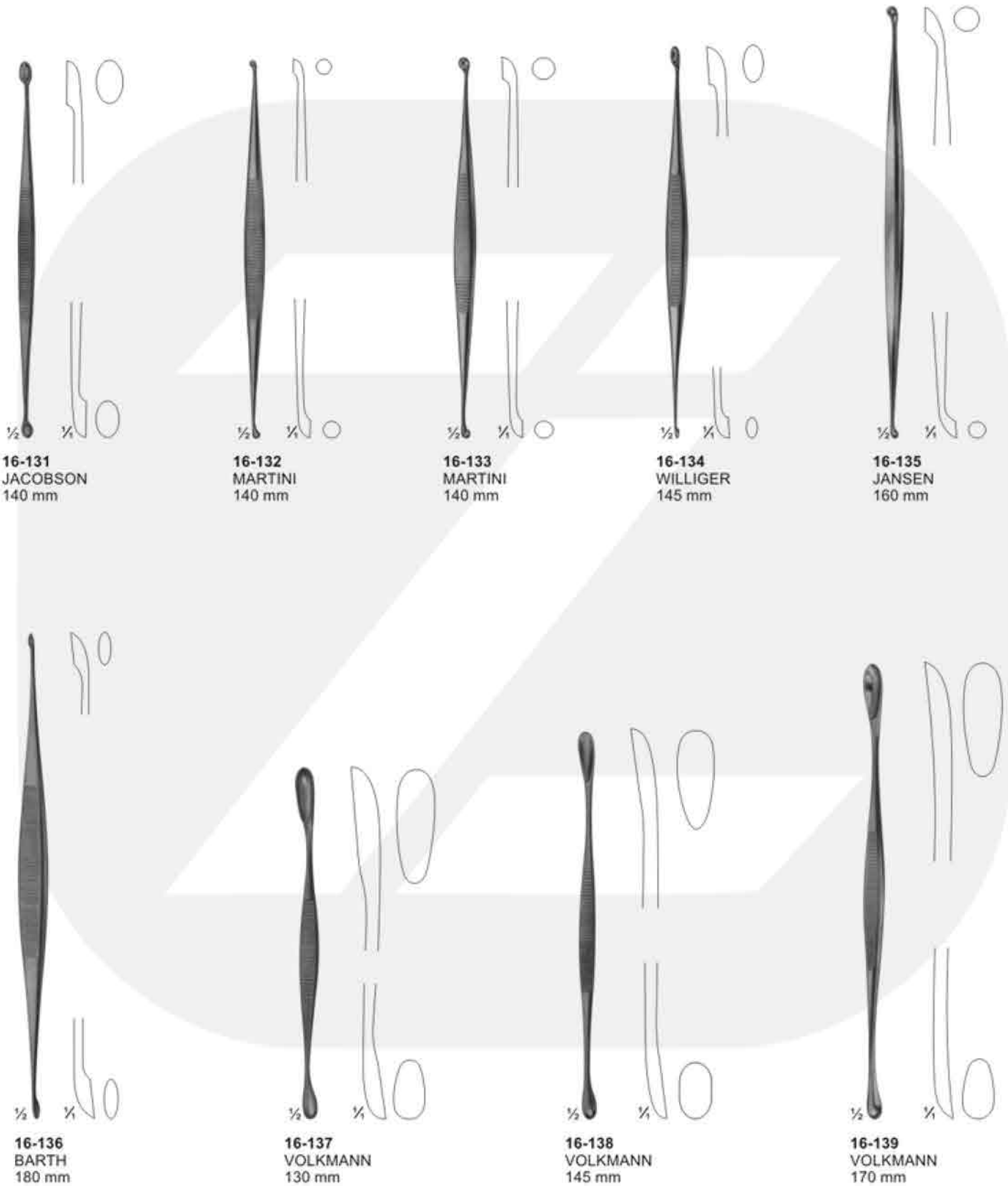

**16-131**  
JACOBSON  
140 mm

**16-132**  
MARTINI  
140 mm

**16-133**  
MARTINI  
140 mm

**16-134**  
WILLIGER  
145 mm

**16-135**  
JANSEN  
160 mm

**16-136**  
BARTH  
180 mm

**16-137**  
VOLKMANN  
130 mm

**16-138**  
VOLKMANN  
145 mm

**16-139**  
VOLKMANN  
170 mm

**Mallets** Weights refer to the heads of the mallets  
**Hammer** Die Gewichtsangaben beziehen sich auf den Kopf des jeweiligen Hammers



∅ 20 mm

½

**17-101**  
**MEAD**  
 185 g  
 with interchangeable  
 plastic disks  
 190 mm  
**17-102**  
 pair of spare disks



∅ 25 mm

½

**17-103**  
 140 g  
 with interchangeable  
 plastic disks  
 185 mm  
**17-104**  
 pair of spare disks



∅ 30 mm

½

**17-105**  
**COTTLE**  
 140 g  
 1 Side Flat  
 1 Side convex  
 185 mm



∅ 22 mm

½

**17-106**  
 165 g  
 lead filled head  
 190 mm

# Osteotomes, Chisels and Gouges



17-107  
MANNERFELT  
Gouge  
155 mm



17-108 - 112  
Osteotomes  
140 mm

17-108	4 mm
17-109	6 mm
17-110	8 mm
17-111	10 mm
17-112	12 mm



17-113 - 117  
Chisels  
140 mm

17-113	4 mm
17-114	6 mm
17-115	8 mm
17-116	10 mm
17-117	12 mm



17-118 - 122  
Gouges  
140 mm

17-118	4 mm
17-119	6 mm
17-120	8 mm
17-121	10 mm
17-122	12 mm



PARTSCH  
17-123 - 126  
Chisels  
140 mm

17-123	3 mm
17-124	4 mm
17-125	5 mm
17-126	6 mm



PARTSCH  
17-127 - 131  
Chisels  
170 mm

17-127	3 mm
17-128	4 mm
17-129	5 mm
17-130	6 mm
17-131	7 mm



PARTSCH  
17-132 - 135  
Gouges  
140 mm

17-132	3 mm
17-133	4 mm
17-134	5 mm
17-135	6 mm



PARTSCH  
17-136 - 140  
Gouges  
170 mm

17-136	3 mm
17-137	4 mm
17-138	5 mm
17-139	6 mm
17-140	7 mm



LUCAS  
17-141 - 142  
Chisels  
160 mm

17-141	4 mm
17-142	6 mm



LUCAS  
17-143 - 144  
Gouges  
160 mm

17-143	3 mm
17-144	5 mm



## Reposition Forceps, Bone Holding Forceps



**17-145**  
Patella forceps  
185 mm



**17-146**  
Forceps with  
ratchet fixation  
140 mm



**17-147**  
Forceps with  
thread fixation  
170 mm



**17-148**  
Forceps with  
thread fixation  
235 mm

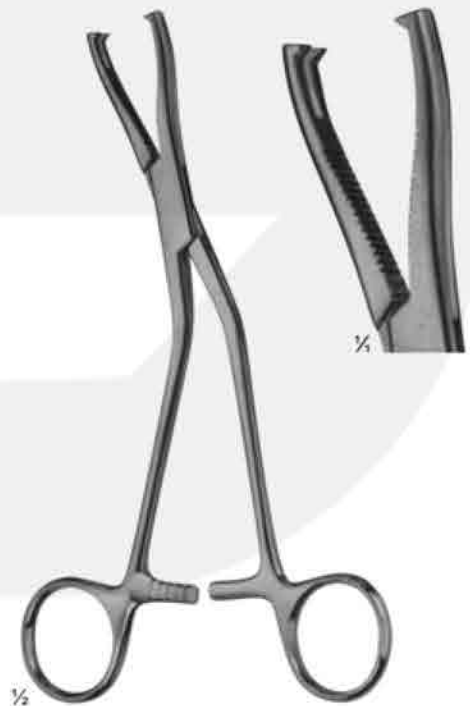

**17-149**  
DINGMANN  
185 mm

## Bone Holding Forceps & Bone Clamps



## Bone Rongeurs



**17-158**  
LUER  
150 mm



**17-159**  
LUER  
155 mm



**17-160**  
BLUMENTHAL  
155 mm



**17-161**  
BLUMENTHAL  
150 mm



**17-162 - 163**  
JANSEN  
175 mm



**17-164**  
BANE-HARTMANN  
175 mm

## Bone Rongeurs

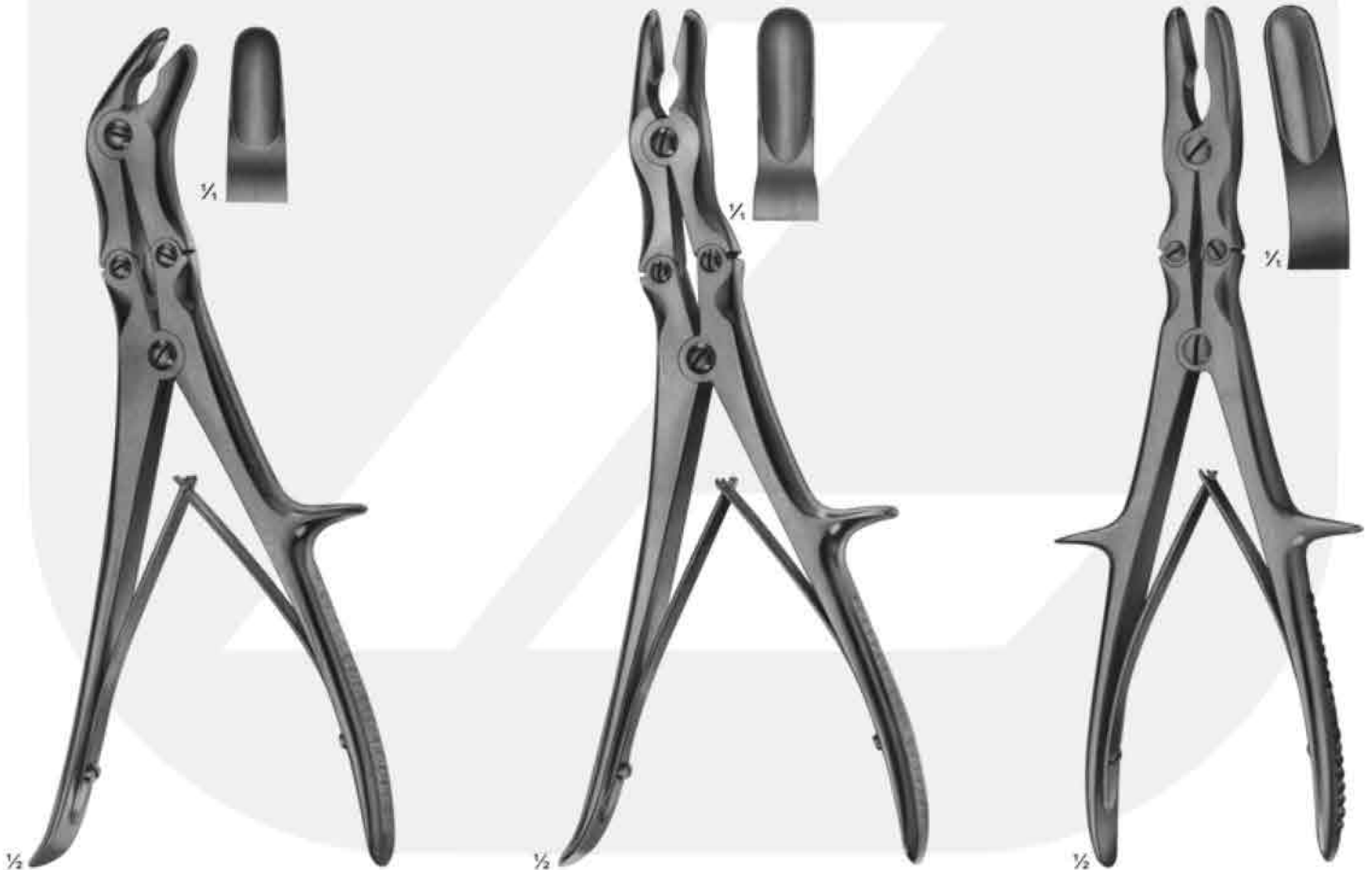

17-165  
STILLE  
235 mm

17-166  
LEKSELL-STILLE  
240mm

17-167  
STILLE-RUSKIN  
240mm



## Bone Cutting Forceps

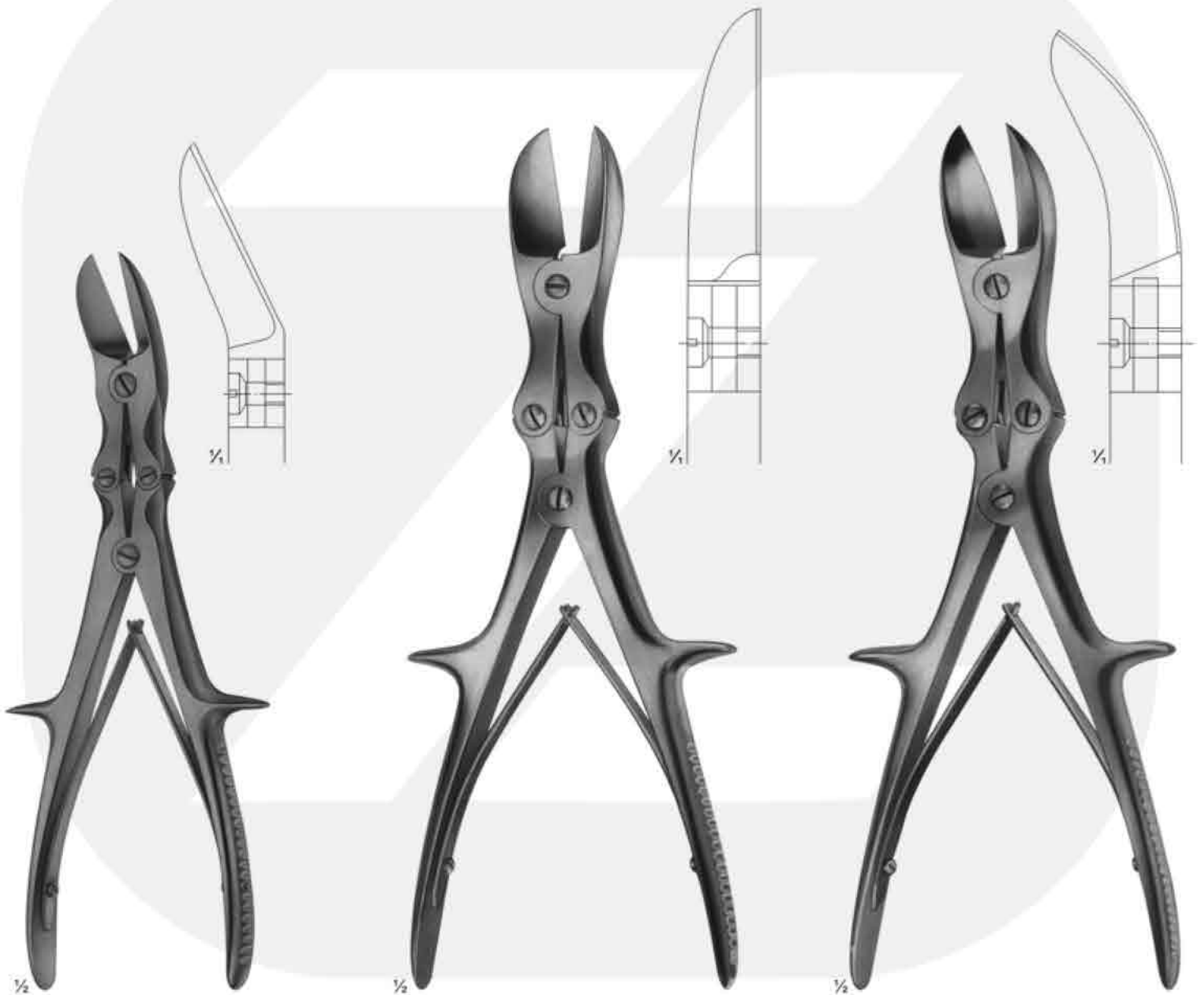

**17-168**  
LISTON  
curved on flat  
240 mm

**17-169**  
LISTON  
straight  
280 mm

**17-170**  
LISTON  
curved on flat  
280 mm

# Wire Extension

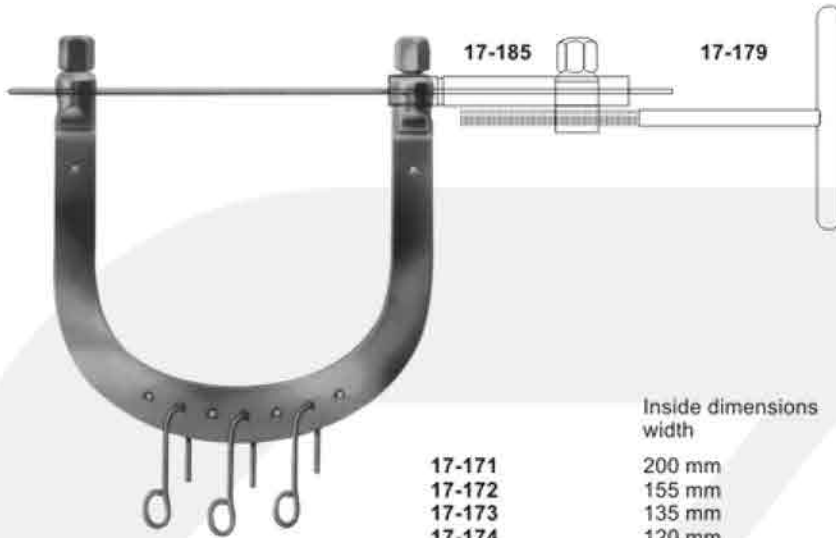

**17-171 - 17-177**  
**KIRSCHNER**  
 Wire traction bows,  
 to be used with  
**KIRSCHNER**-wires  
 up to 2.5 mm diam.,  
 With 3 hooks,  
 stainless steel

	Inside dimensions width	depth	
17-171	200 mm	155 mm	for the hip
17-172	155 mm	155 mm	for the femur
17-173	135 mm	130 mm	for the knee
17-174	120 mm	120 mm	for the knee
17-175	105 mm	100 mm	for the knee
17-176	95 mm	110 mm	for the calcaneus
17-177	95 mm	70 mm	for the arm and elbow



**17-178**  
 Wrench, double - ended,  
 for wire traction bows



**17-179**  
 Wire tightener, with  
 clamping jaws



**17-182** max. 105 mm  
**17-183** max. 160 mm  
**17-184** max. 200 mm

**17-182** 80-95 mm  
**17-183** 90-120 mm  
**17-184** 140-170 mm

diam upto  
**17-182** 1,6 mm  
**17-183** 2,0 mm  
**17-184** 2,5 mm

**17-182 - 17-184**  
**KIRSCHNER**  
 Wire traction bows, modified,  
 adjustable in width, holds wire  
 securely, with 1 hook



**17-180**  
 Traction hook only,  
 large size



**17-181**  
 Traction hook only,  
 small size



**17-185**  
 Fixation clamp, to secure clamping  
 jaws of 17-179 stainless steel

## Cerclage Instruments

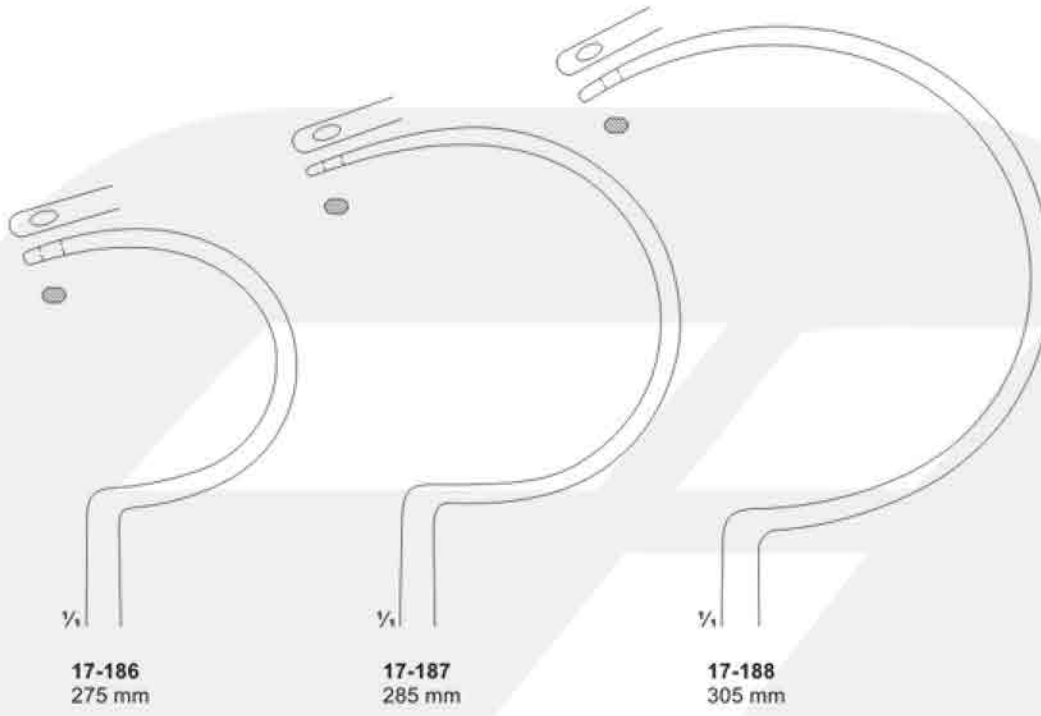

**17-186**  
275 mm

**17-187**  
285 mm

**17-188**  
305 mm



**17-186 - 17-188**  
DEMEL  
Wire guides

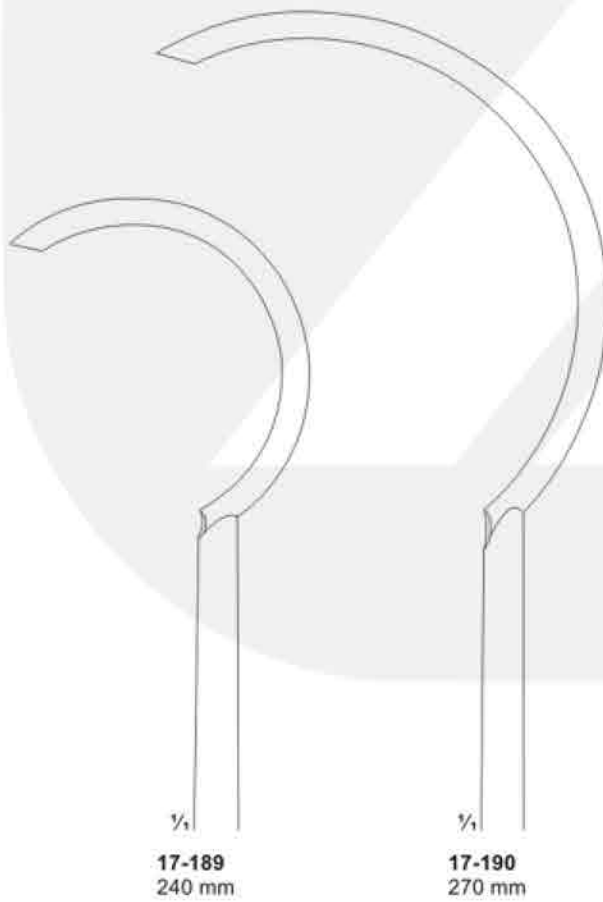

**17-189**  
240 mm

**17-190**  
270 mm



**17-191**  
225 mm

# Wire Holding forceps, Wire Tightening Pliers, Flat-nosed Pliers DUROGRIP with Hard Metal Inserts



**17-192**  
DUROGRIP  
Holding forceps for cerclage wire, with lateral jaws to avoid wire slipping off  
170 mm



**17-193**  
DUROGRIP  
Wire, tightening pliers,  
Ligature pliers  
150 mm



**17-194**  
DUROGRIP  
Wire, tightening pliers,  
Ligature pliers  
150 mm



**17-195**  
with serrated jaws  
140 mm



**17-196**  
one jaw smooth,  
one jaw serrated  
140 mm



**17-197**  
with serrated jaws  
**17-198**  
with longitudinal and  
transversal grooves  
170 mm



**17-199**  
190 mm



# Wire Holding forceps, Flat-nosed Pliers, Pliers for bending and cutting wires



17-200  
130 mm



17-201  
180 mm



17-200 - 17-201  
Extraction pliers  
for boring wires



17-202  
Flat-nosed pliers,  
parallel  
185 mm

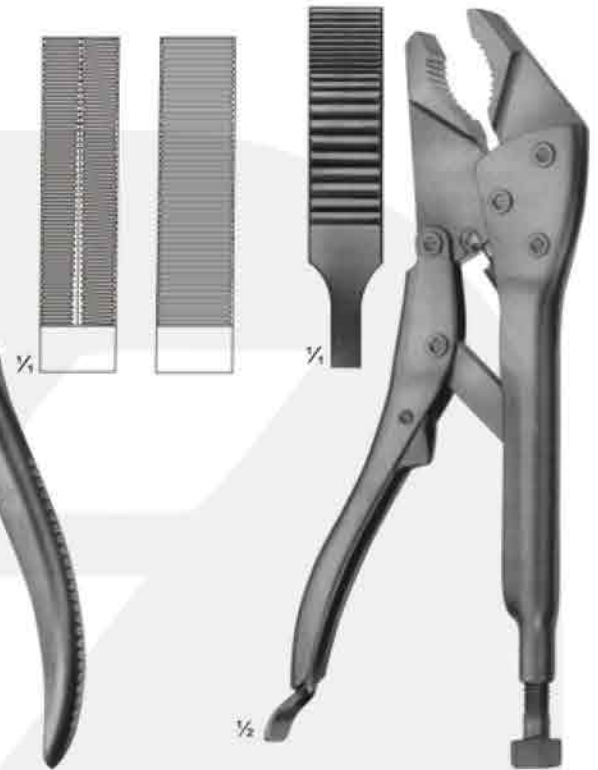

17-203  
Vise grip  
200 mm

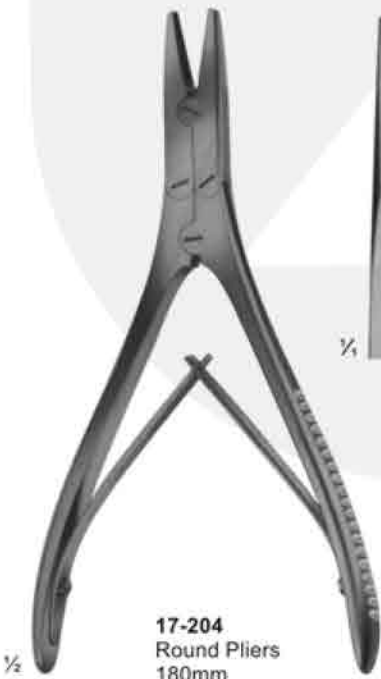

17-204  
Round Pliers  
180mm



17-204



17-204



17-205



17-206



17-207

17-205 145 mm  
17-206 180 mm  
17-207 180 mm  
Extraction pliers for wires

17-204 - 17-207



17-208  
Bending pliers  
for wires up to  
1.8 mm diam.



# Wire Cutters and wire Cutting Scissors DUROTIP with Carbide Cutting Edges



**17-209**  
ANGLE  
130 mm

for soft wire  
up to diam.  
for hard wire  
up to diam.

0,5 mm  
0,3 mm



**17-210**  
DUROTIP  
ANGLE  
130 mm

0,6 mm  
0,4 mm

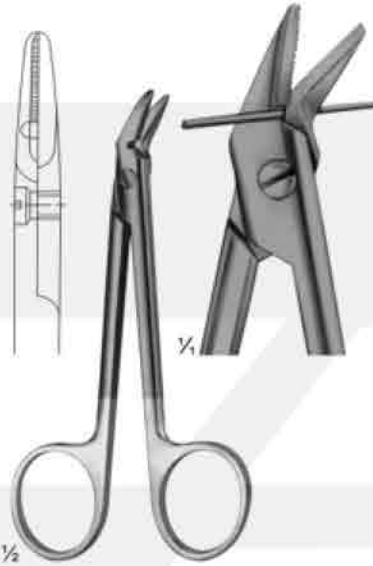

**17-211**  
120 mm

for soft wire  
up to diam.  
for hard wire  
up to diam.

1,2 mm  
0,8 mm

**17-212**  
DUROTIP  
120 mm

1,2 mm  
0,8 mm

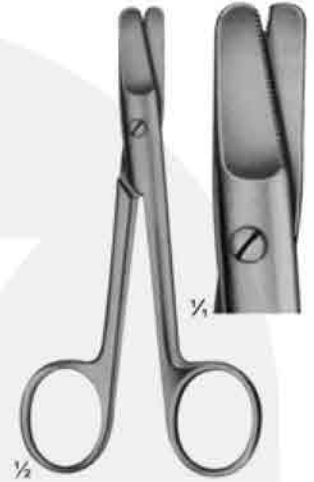

**17-213**  
HARVEY  
125 mm

0,4 mm  
0,3 mm



**17-214**  
150 mm

for soft wire  
up to diam  
for hard wire  
up to diam

1,5 mm  
1,0 mm



**17-215**  
160 mm

1,5 mm  
1,2 mm



**17-216**  
140 mm  
DUROTIP  
1,5 mm

1,0 mm

# Wire Cutting Pliers, Lateral Cutting Action



**17-217**  
180 mm

for soft wire  
up to diam. 2,0 mm  
For hard wire 1,5 mm  
up to diam  
specially hardened  
cutting edges, front  
and lateral cutting  
action

**17-218**  
REILL  
175 mm

for soft wire  
up to diam. 2,0 mm  
For hard wire 1,6 mm  
up to diam  
specially hardened  
cutting edges, for  
cutting off wires close  
to the bone

**DUROTIP**

**17-219**  
235 mm

for soft wire  
up to diam. 3,0 mm  
For hard wire 2,2 mm  
up to diam

## Wire Cutting Pliers, Lateral and Front Cutting Action



## Wire Cutting Pliers



**17-224**  
320 mm

for soft wire  
up to diam. 3,0 mm  
For hard wire  
up to diam. 3,0 mm



Cutter for cutting off  
KIRSCHNER wires,  
Tibia head screws,  
bolts, pins, up to 3 mm diam.



**DURROTIP**

**17-225**  
Cutter for cutting off  
KIRSCHNER wires,  
Tibia head screws,  
bolts, pins, up to 6 mm diam.  
470 mm

## Finger Nail Instruments

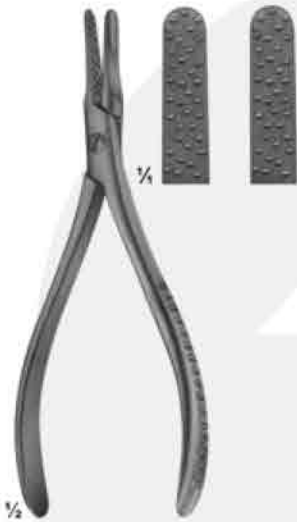

**17-226**  
Nail extracting  
forceps  
135 mm



**17-227**  
Nail extracting  
forceps  
145 mm

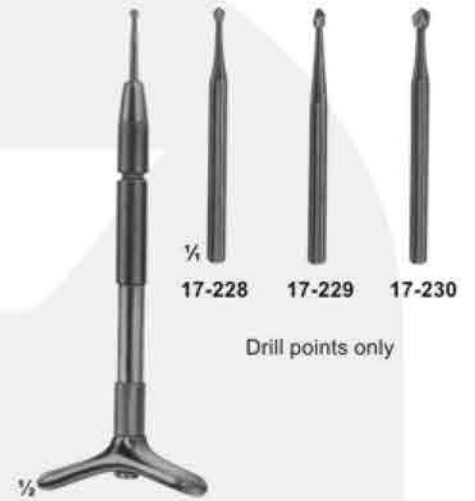

**17-228**  
Finger nail drill  
with 3 drill points

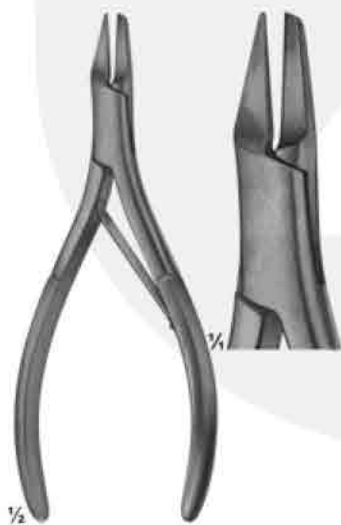

**17-231**  
Nail splitting  
forceps  
135 mm



**17-232**  
SYSTRUNK  
Scissors, for splitting  
finger nails  
130 mm



**17-233**  
Finger ring saw  
150 mm



## Plaster Shears



17-235  
STILLE-AESFULAP  
260 mm

17-236  
STILLE-AESFULAP  
360 mm

## Plaster Spreader, Plaster Breakers



with removable jaws

17-237  
HENING  
270 mm

17-238  
MOD.USA  
230 mm

17-239  
290 mm

17-240 - 17-241  
WOLFF  
17-240 180 mm  
17-241 240 mm  
plaster breakers

# Vacuum Curettes for Aspiration Lipectomy, Suction Instruments



**18-101 - 18-106**

BIEMER

- 18-101  $\varnothing$  4 mm
- 18-102  $\varnothing$  6 mm
- 18-103  $\varnothing$  8 mm
- 18-104  $\varnothing$  10 mm
- 18-105  $\varnothing$  12 mm
- 18-106  $\varnothing$  14 mm

Curettes for aspiration lipectomy, graduated, slightly curved

**18-107 - 18-108**

BIEMER

- 18-107  $\varnothing$  4 mm
  - 18-108  $\varnothing$  6 mm
- Curettes for aspiration lipectomy, with three apertures, slightly curved malleable

**18-109 - 18-111**

BIEMER

- 18-109  $\varnothing$  8 mm
  - 18-110  $\varnothing$  10 mm
  - 18-111  $\varnothing$  12 mm
- Curettes for aspiration lipectomy, with three apertures, slightly curved malleable

**18-112**

For aspirating fluid from the excretory ducts of large glands and for keeping the operating area clear 170 mm

**18-113**

Trocar For puncturing 150 mm

**18-114**

For clearing large quantities of fluid 190 mm

## Suction Instruments

**18-115** 150mm  
Suction handle, with vacuum regulator and finger cut-off, brass, mirror-finish chromium-plated



olive  
Ø9 mm

**18-116** 170mm  
Suction handle, with hand regulation valve and quick-shutter, brass, mirror-finish chromium-plated



Both suction handles have bayonet fitting olive and can be used for the suction cannulae. Ø9 mm



**18-117**  
Trocar  
For puncturing  
170 mm



**18-118**  
Hollow needle,  
sharp  
150 mm



**18-119**  
double curved  
For general  
surgery  
230 mm



**18-120**  
For tonsillectomy,  
oral and laryngeal  
operations  
190 mm



**18-121**  
For tonsillectomy,  
oral and laryngeal  
operations  
220 mm

★ With bayonet fitting to be used with suction handles (18-115 - 18-116)

# Suction Instruments

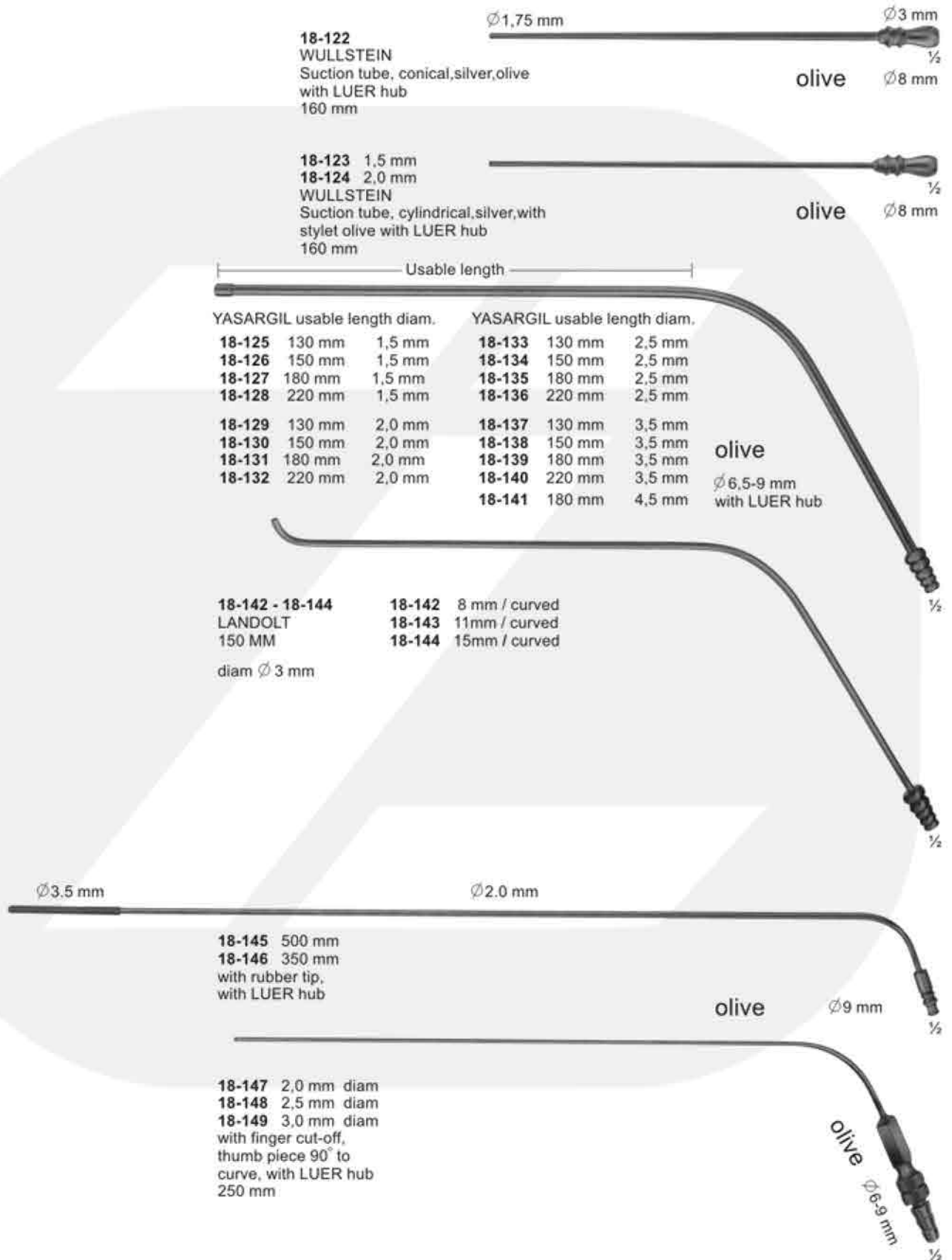



# Combined Suction and Irrigation Cannulae, Coagulation Suction Cannulae

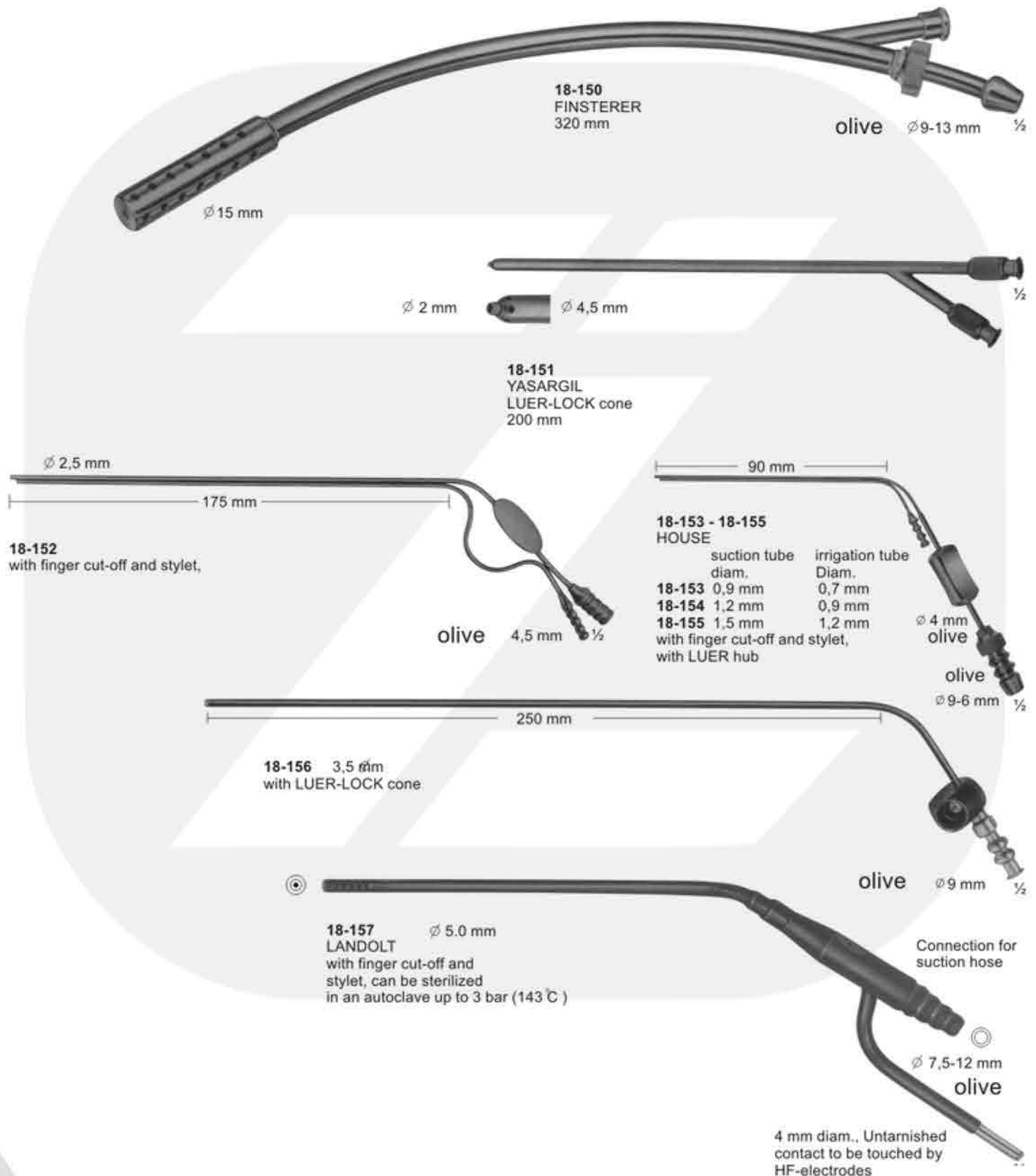

# Suction Instruments

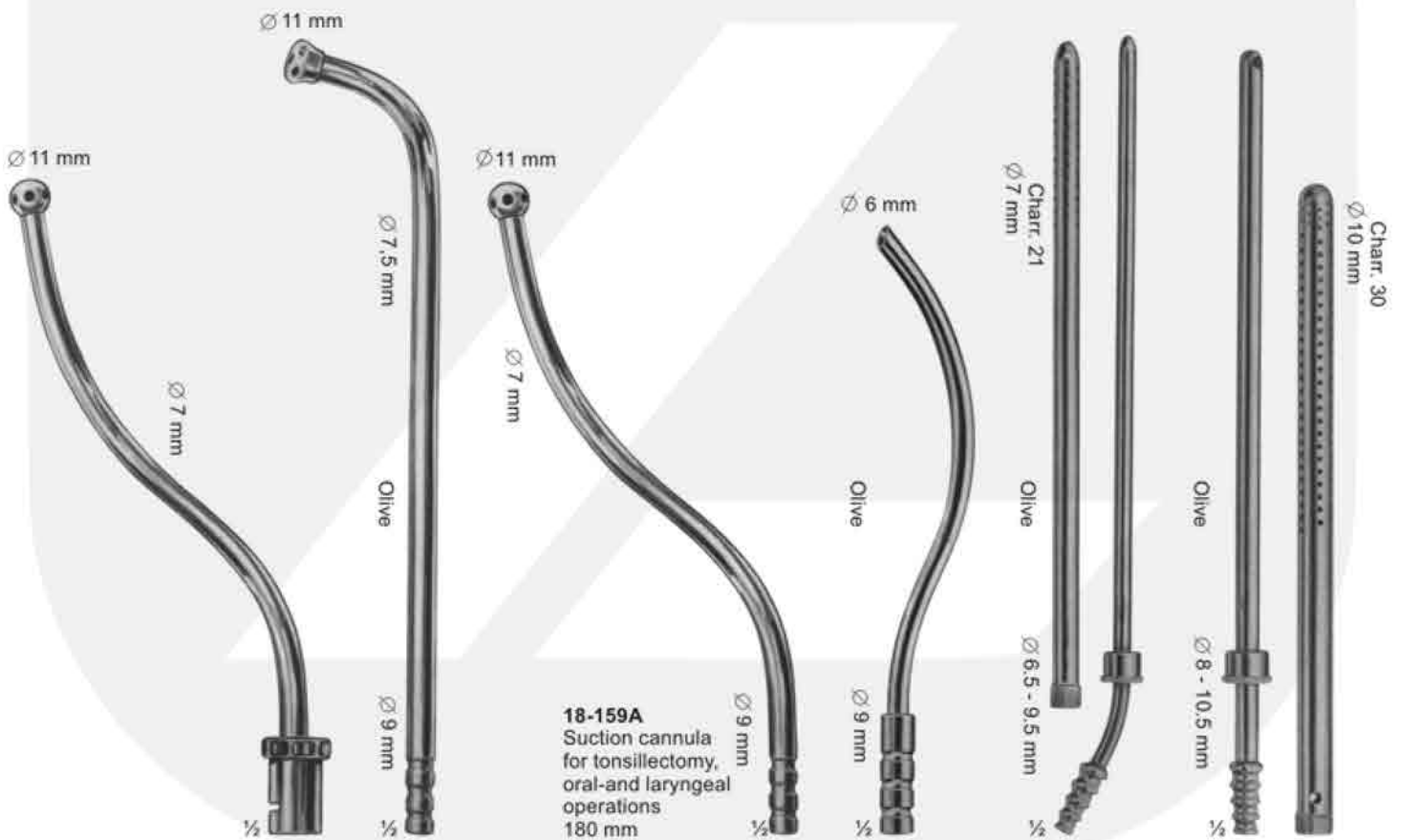

**18-158**  
For tonsillectomy,  
oral-and laryngeal  
operations  
180 mm

**18-159**  
Suction cannula  
for tonsillectomy,  
oral-and laryngeal  
operations  
220 mm

**18-160**  
S-shaped blunt cannula  
for aspirating fluid from  
the excretory ducts of  
large glands and for  
keeping the operating  
area clear  
170 mm

**18-161**  
POOL  
Suction cannula,  
with outer tube  
to be screwed of  
225 mm

**18-162**  
POOL  
Suction cannula,  
with outer tube  
to be screwed off  
225 mm

# Suction Instruments

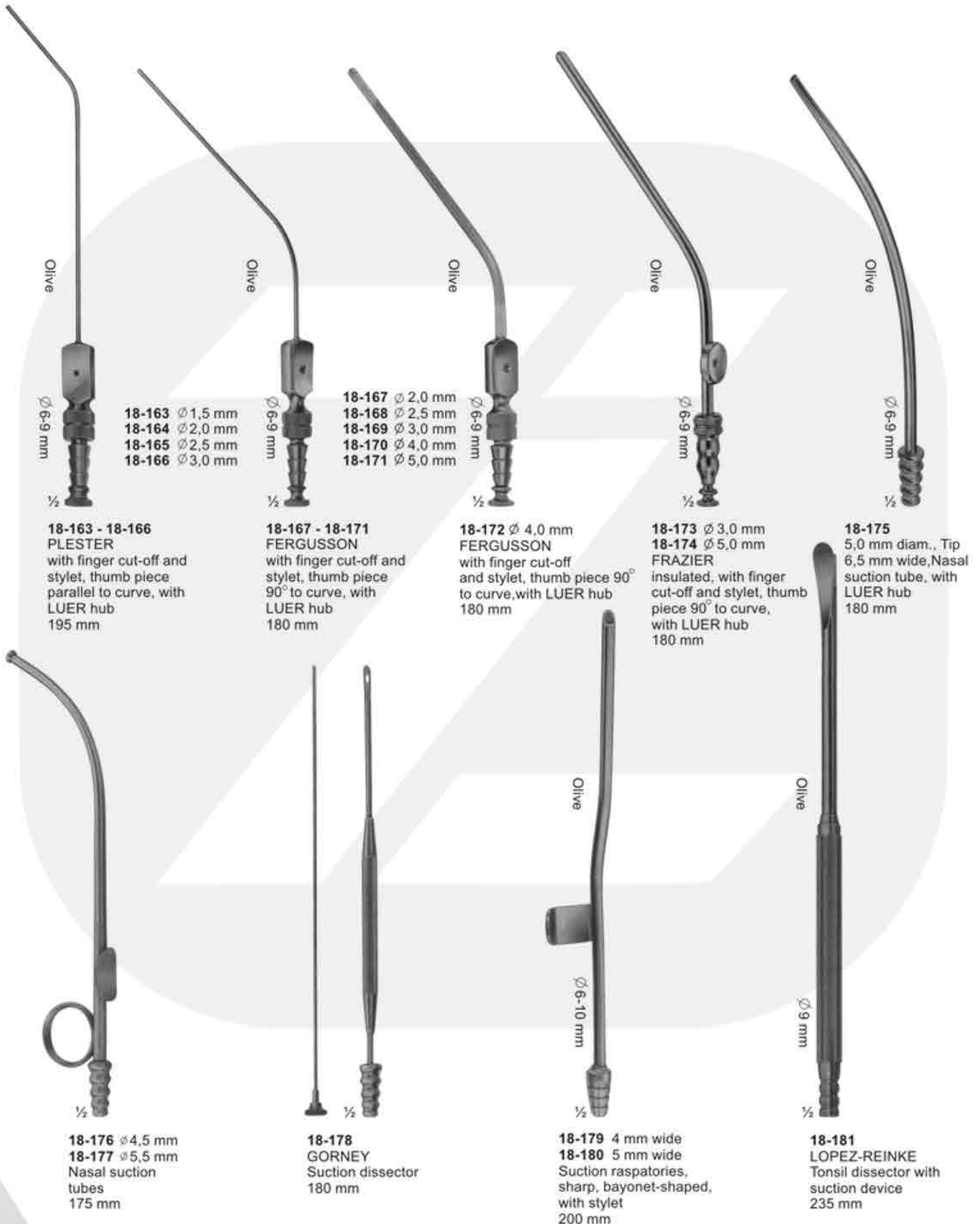

## Dissection Instruments



### 18-182

- 1- Blow pipe .
- 2- 3 PCS .scalpel.
- 3- Dissecting forcep 13 cm.
- 4- Grooved director with tounge tie 13 cm.
- 5- Triple chain hook.
- 6- Dressing scissors probe pointed 13 cm.
- 7- Probe double 13 cm.
- 8- Zipper case inside red velvet.



### 18-183

- 1- Probe Double 13 cm
- 2- 2 PCS. Scalpel S.S
- 3- Grooved Director With tongue Tie 13 cm
- 4- Mayo Hegar Needle Holder 13cm
- 5- Disscting Forcep 13 cm 1x2 Teeth
- 6- Dressing Forcep 13 CMS Serrated.
- 7- Dressing Scissor 13 cm S/B STR.
- 8- Dressing Scissor 13 cm S/B CVD.
- 9- Zipper Case Inside Red Velvet.



### 18-184

- 1- Dissecting Forcep 11.5 cm Sharp Point.
- 2- Iris Scissor
- 3- B.P Handle No. 4
- 4- Teasing Needle Sharp angular.
- 5- Blade No. 22
- 6- Thumb Forceps T.O.E 13 cm
- 7- Dissecting Scissor STR 11.5 cm
- 8- Dissecting Scissor STR 13 cm
- 9- Zipper case Inside Red Velvet



### 18-185

- 1- Grooved Director with Tongue Tie 14 cm
- 2- Probe Double 14cm
- 3- Mayo Hegar Needle Holder 14 cm
- 4- BP. Handle no.3
- 5- BP. Handle no.4
- 6- Dressing Scissor 14 cm S/B STR
- 7- Dressing Scissor 14 cm S/B CVD.
- 8- Dressing Forcep 1x2 Teeth 14 cm
- 9- Dressing Forcep Serrated 14 cm



### 18-186

- 1- Probe double 12.5 cm
- 2- Scalpel
- 3- B.P Handle No. 4
- 4- 6 PCS Blade 2 each no. 21, 22, 23
- 5- Dissecting Forcep 12.5 cm
- 6- Dissecting Forcep 11.5 cm sharp Point
- 7- Dissecting Scissor S/B STR 13 cm
- 8- Dissecting Scissor S/S STR 13 cm

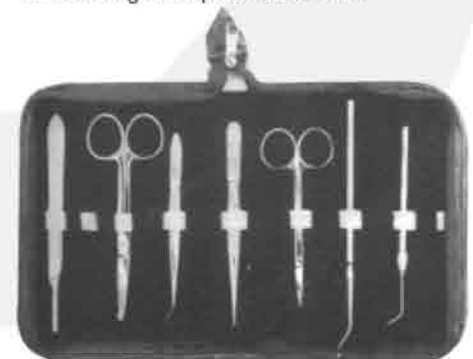

### 18-187

- 1- Teasing Needle with Chuck CVD.
- 2- Huber Probe
- 3- Iris Scissor
- 4- Dissecting Forcep Fine 14 cm.
- 5- Dissecting Forcep Fine CVD. 12 cm
- 6- Operating Scissor with Probe 14 cm.
- 7- B.P. Handle no. 4



## Dissection Instruments



### 18-188

- 1- Probe with eye
- 2- Dissecting Forcep cvd fine 12 cm.
- 3- Iris Scissor
- 4- Operating Scissor S/B str 14 cm
- 5- Grooved Director and Tongue tie
- 6- Huber Probe
- 7- Triple Chain Hook
- 8- B.P Handle No. 4
- 9- B.P Handle No. 3
- 10- Teasing Needle with Chuck cvd.
- 11- Teasing Needle with Chuck str.
- 12- Dissecting Forceps Fine 14 cm.

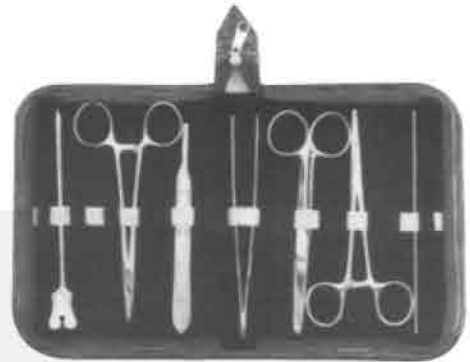

### 18-189

- 1- Grooved Director and Tongue tie
- 2- Mayo Hearg Needle Holder 14 cm
- 3- B.P Handle No. 4
- 4- Dissecting Forceps Thump 14 cm.
- 5- Operating Scissor S/B str 14 cm
- 6- Kelly Forcep STR 14 cm.
- 7- Probe Double end

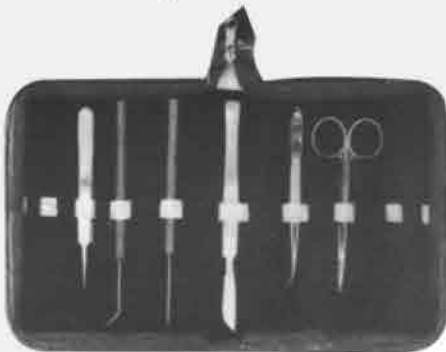

### 18-190

- 1- Iris Scissor STR
- 2- Dissecting Forceps CVD 12 cm.
- 3- Scapel
- 4- Teasing Needle STR wooden handle.
- 5- Teasing Needle CVD wooden handle.
- 6- Watchmaker fine point.



### 18-191

- 1- Probe Double end
- 2- B.P Handle No. 4
- 3- Dissecting Forcep 1x2 Teeth 14 cm.
- 4- Operating Scissor S/B str 14 cm
- 5- Mayo Hearg Needle Holder 14 cm
- 6- Kelly Forcep STR 14 cm.
- 7- Operating Scissor S/B CVD 14 cm
- 8- Grooved Director and Tongue tie
- 9- Dissecting Forceps Thumb 14 cm.



### 18-192

- 1- Probe double end.
- 2- Grooved director and tounge tie.
- 3- B.P handle no.4
- 4- Operating scissor STR S/b14cm.
- 5- Kelly forceps STR 14cm.
- 6- Dissecting forceps thumb 13cm.

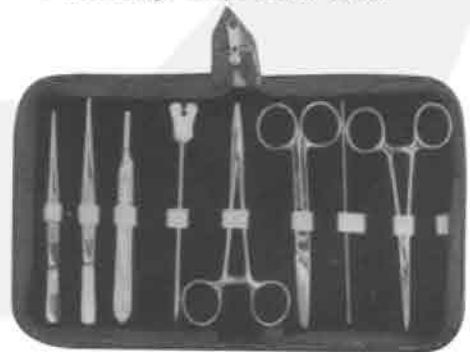

### 18-193

- 1- Dissecting Forceps Thumb 14 cm
- 2- Dissecting Forcep 1x2 Teeth 14 cm.
- 3- B.P Handle No. 3
- 4- Grooved Director and Tongue tie
- 5- Mayo Hearg Needle Holder 14 cm
- 6- Operating Scissor S/B str 14 cm
- 7- Probe Double end
- 8- Kelly Forcep STR 14 cm.



## Dissection Instruments



### 18-194

- 1- Dissecting Forcep Fine 14cm.
- 2- Dissecting Forcep Fine CVD 12cm
- 3- Dissecting Forcep with Pin 14cm.
- 4- Watchmaker Fine point
- 5- Iris scissor STR
- 6- Iris scissor CVD.
- 7- Teasing Needle holder
- 8- Teasing Needle STR.
- 9- B.P. Handle no. 3



### 18-195

- 1- Teasing Needle STR.
- 2- Grooved Director and Tongue Tie.
- 3- Teasing Needle CVD.
- 4- Dissecting Forcep with Pin 12 cm Fine
- 5- Operating Scissor S/B STR 14 cm
- 6- Triple Chain Hook
- 7- Probe with eye
- 8- Probe Double end
- 9- Probe and Hook
- 10- Dissecting Forcep Fine 14 cm
- 11- Iris Scissor
- 12- Huber Probe
- 13- B.P. Handle no.3
- 14- B.P. Handle no.4



### 18-196

- 1- Dissecting forcep fine STR with pin 12cm.
- 2- Iris scissor STR.
- 3- Probe with eye.
- 4- Probe and hook.
- 5- Operating scissor S/B STR 14cm.
- 6- Triple chain hook.
- 7- B.P. handle no.4
- 8- Humber probe.
- 9- B.P.handle no.3
- 10- Teasing needle STR plastic handle.
- 11- Teasing needle CVD plastic handle.
- 12- Grooved director and tongue tie.
- 13- Probe double end.



### 18-197

- 1- Dissecting Forceps Thumb 14 cm.
- 2- Dissecting Forcep 1x2 Teeth 14 cm.
- 3- B.P. Handle No. 3
- 4- Grooved Director and Tongue tie
- 5- Mayo Hearn Needle Holder 14 cm
- 6- Operating Scissor S/B str 14 cm
- 7- Probe Double end
- 7- Kelly Forcep STR 14 cm.

# Hospital Wares



**19-101 - 115**  
Schimmelbusch

Ø x H  
sizes in mm

<b>19-101</b>	80 x 80
<b>19-102</b>	105 x 120
<b>19-103</b>	140 x 140
<b>19-104</b>	160 x 120
<b>19-105</b>	160 x 150
<b>19-106</b>	190 x 150
<b>19-107</b>	190 x 190
<b>19-108</b>	240 x 160
<b>19-109</b>	240 x 240
<b>19-110</b>	290 x 160
<b>19-111</b>	290 x 240
<b>19-112</b>	340 x 160
<b>19-113</b>	340 x 340
<b>19-114</b>	390 x 190
<b>19-115</b>	390 x 290



**19-116**  
Box  
120 x 65 x 13mm  
(without Bulldog clamps,  
without silicone tape)



**19-117**  
Box with support  
120 x 65 x 13 mm  
(ohne Bulldogklemmen)



**19-118**  
Box with support for  
needle electrodes,  
without instruments



**19-119 - 121**  
50 x 25 x 4,5 mm  
**19-120**  
65 x 42 x 8 mm  
**19-121**  
75 x 25 x 4,5 mm



**19-122**  
Ø 65mm x 15mm

# Hospital Wares



**19-123 - 131**

	Ø x H
19-123	30 x 90 mm
19-124	50 x 100 mm
19-125	50 x 130 mm
19-126	50 x 175 mm
19-127	75 x 100 mm
19-128	75 x 130 mm
19-129	75 x 175 mm
19-130	100 x 175 mm
19-131	100 x 200 mm

**19-141 - 142**

- 19-141** Martin Sterilizing Forceps consisting of:  
 1 Sterilizing Forceps, curved, 25 cm, without ratchet, with lid for jar  
 1 jar with bottom plate (anti-tilt)
- 19-142** ditto, with 32 cm long Sterilizing Forceps



**19-132 - 139**

19-132	165 x 85 x 35 mm
19-133	200 x 100 x 35 mm
19-134	200 x 100 x 50 mm
19-135	230 x 130 x 50 mm
19-136	260 x 150 x 50 mm
19-137	270 x 235 x 50 mm
19-138	300 x 200 x 50 mm
19-139	325 x 275 x 50 mm



**19-140**  
 205 x 105 x 35 mm

## Round Metal Boxes and Medicine Cups



19-143 - 148

	Ø x H
19-143	75 x 60 mm
19-144	75 x 75 mm
19-145	100 x 60 mm
19-146	100 x 100 mm
19-146A	125 x 80 mm
19-147	125 x 125 mm
19-148	150 x 150 mm

19-149  
25 cc

19-150  
50 cc



19-151  
20 cc  
Medicine Spoon



19-152  
Ø 75 x 12 mm  
Tablet Tray



19-153  
Ø 90 x 90 mm  
Metal Cup



19-154  
Ø 75 x 80 mm  
Sputum Cup



Kidney Dish



19-155 - 157

19-155	170 x 100 x 35 mm
19-156	250 x 140 x 40 mm
19-157	275 x 150 x 45 mm



# Hospital Wares



19-158 - 165

	Ø x H		
19-158	40 x 19 mm	0.05L	
19-159	61 x 30 mm	0.07L	
19-160	80 x 40 mm	0.14L	
19-161	116 x 50 mm	0.35L	
19-162	128 x 55 mm	0.45L	
19-163	147 x 65 mm	0.70L	
19-164	167 x 75 mm	1.10L	
19-165	187 x 85 mm	1.60L	



19-166 - 170

19-166	116 x 35 mm	0.30L
19-167	128 x 38 mm	0.40L
19-168	147 x 40 mm	0.50L
19-169	157 x 45 mm	0.75L
19-170	187 x 45 mm	1.00L



19-171  
Ø 110 x 28 mm 0.15L



19-172  
100 cc 0.1L



19-173 - 176  
19-173 0.25L  
19-174 0.50L  
19-175 1.00L  
19-176 2.00L



19-177  
235 x 190 x 40 mm



19-178  
Ø 220 x 70 mm



## Hospital Wares



**19-179**  
∅ 50 x 100 mm  
Powder Pot



**19-180**  
∅ 50 x 75 mm  
Methot With Lid



**19-181**  
∅ 50 x 75 mm  
Methot Without Lid



**19-182**



**19-183**



**19-184**



**19-185 - 186**

**19-185** ∅ 235 mm  
**19-186** ∅ 310 mm

# Needle Cases



**19-187**  
Sauerbruch  
210 x 125 x 17 mm



**19-188**  
Sauerbruch  
210 x 125 x 17 mm



**19-189**  
150 x 95 x 13 mm



**19-190**  
150 x 95 x 13 mm



**19-191**  
150 x 95 x 13 mm



**19-192**  
150 x 95 x 13 mm



**19-193**  
150 x 95 x 13 mm



**19-194**  
150 x 95 x 13 mm



**19-195**  
150 x 95 x 11 mm

# Storing Cases



**19-199 - 209**

<b>19-199</b>	230 x 130 x 50	mm
<b>19-200</b>	260 x 150 x 50	mm
<b>19-201</b>	275 x 235 x 50	mm
<b>19-202</b>	300 x 200 x 50	mm
<b>19-203</b>	325 x 275 x 50	mm
<b>19-204</b>	420 x 175 x 50	mm
<b>19-205</b>	230 x 130 x 75	mm
<b>19-206</b>	260 x 150 x 75	mm
<b>19-207</b>	300 x 200 x 75	mm
<b>19-208</b>	325 x 275 x 75	mm
<b>19-209</b>	420 x 175 x 75	mm



**19-196**  
Deponette  
245 x 135 x 35mm



**19-197**  
Deponette  
245 x 135 x 50mm



**19-198**  
Deponette  
245 x 135 x 60mm



## Sterilizing Baskets / Trays

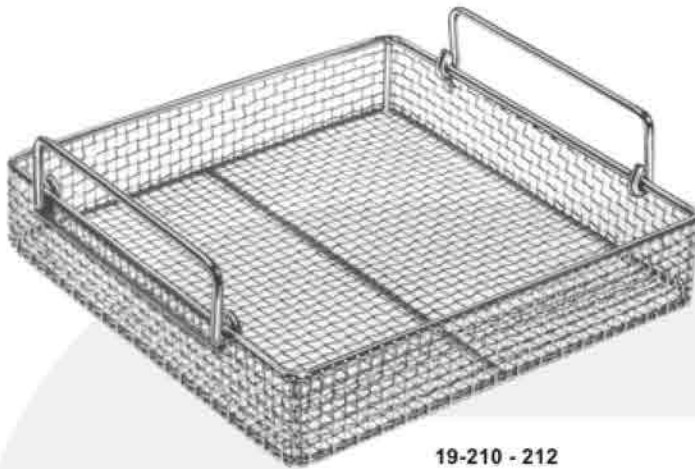

19-210 - 212

19-210	480 x 250 x 50	mm
19-211	520 x 250 x 75	mm
19-212	520 x 250 x 100	mm

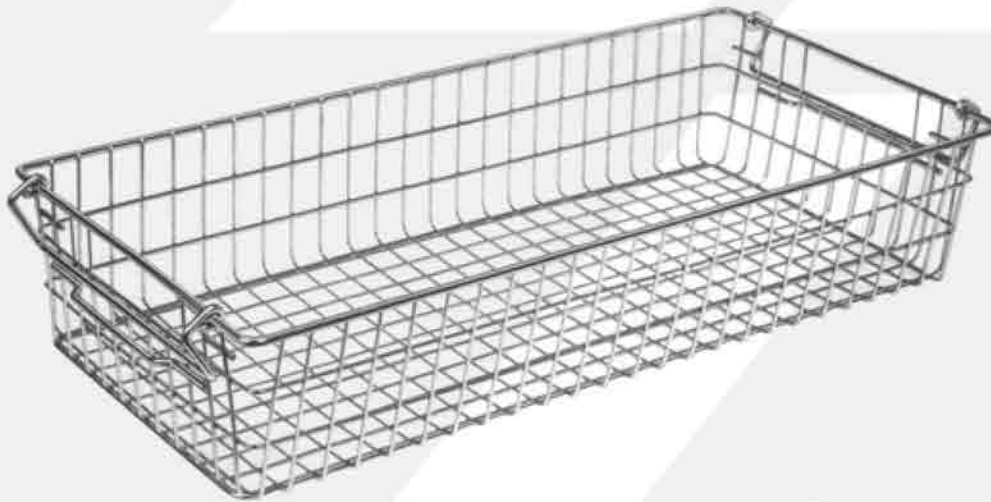

19-219  
(60 x 30 x 15 cm)  
Nominal dimensions



19-213 - 218

19-213	240 x 240 x 50	mm
19-214	240 x 240 x 80	mm
19-215	240 x 240 x 100	mm
19-216	480 x 260 x 50	mm
19-217	520 x 260 x 80	mm
19-218	520 x 260 x 100	mm

## Scissors with Tungsten Carbide Inserts



**26-101**  
Standard



14,5cm  
16,5cm  
18,5cm



**26-102**  
Standard

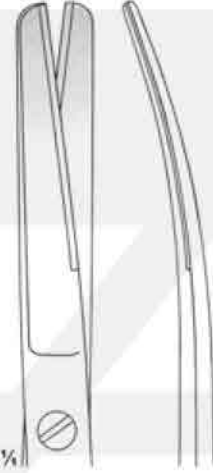

14,5cm  
16,5cm  
18,5cm



**26-103**  
Standard

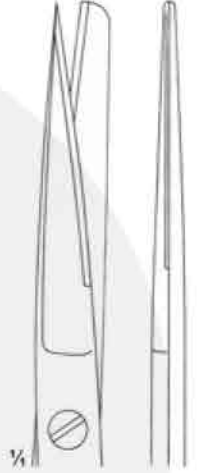

14,5cm  
16,5cm  
18,5cm



**26-104**  
Standard



14,5cm  
16,5cm  
18,5cm



**26-105**  
Standard



14,5cm  
16,5cm  
18,5cm



**26-106**  
Standard



14,5cm  
16,5cm  
18,5cm



## Scissors with Tungsten Carbide Inserts

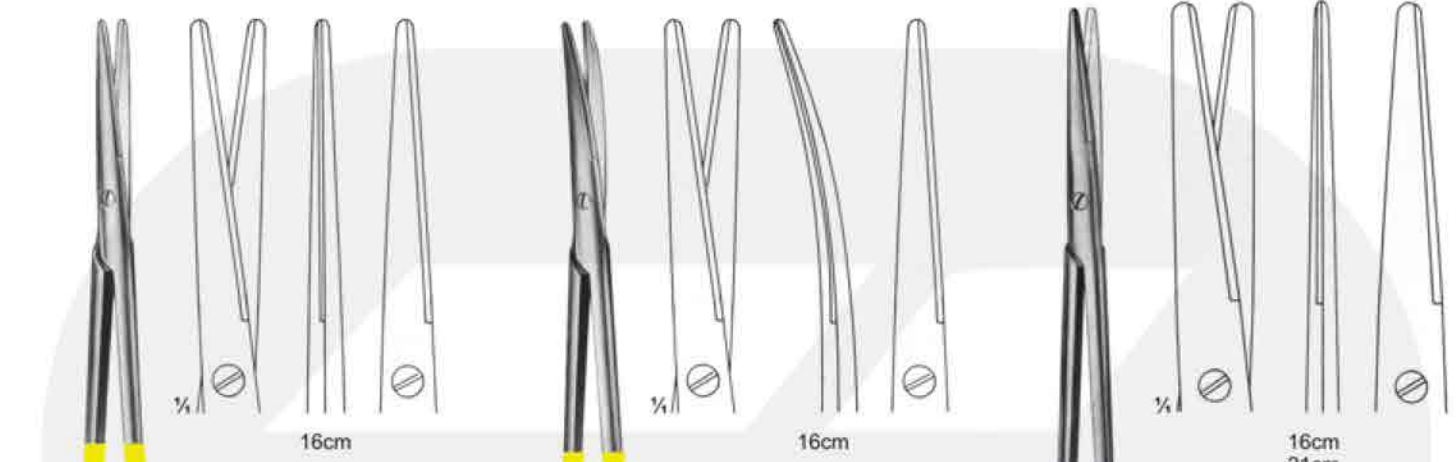

1/2  
**26-107**  
Mayo-Lexer

1/2  
**26-108**  
Mayo-Lexer

1/2  
**26-109**  
Lexer

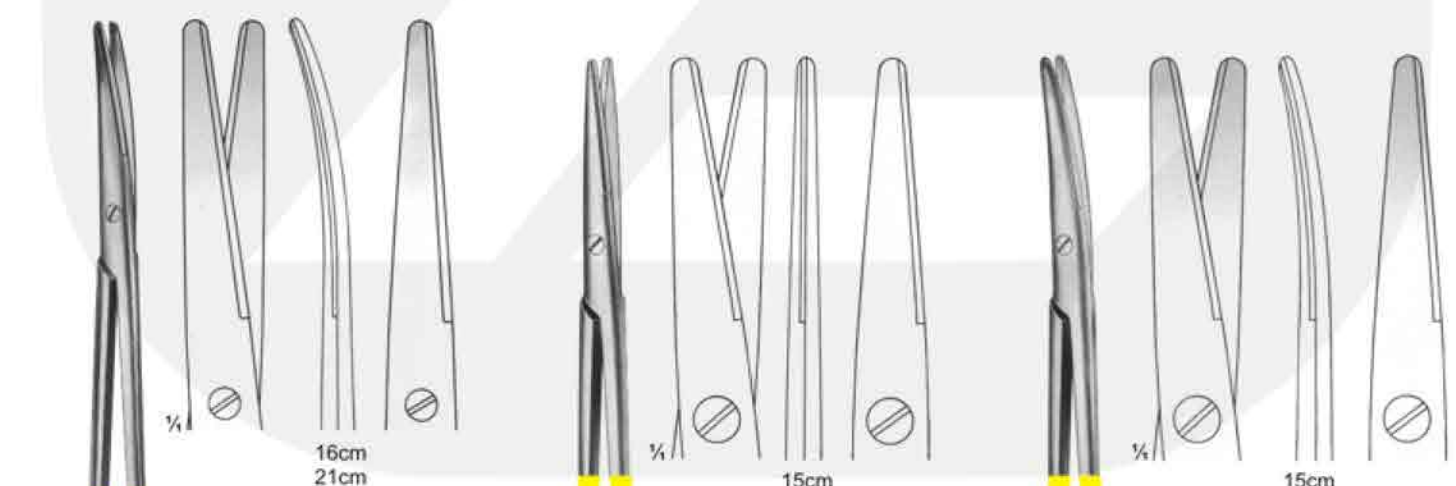

1/2  
**26-110**  
Lexer

1/2  
**26-111**  
Mayo-Stille

1/2  
**26-112**  
Mayo-Stille

## Scissors with Tungsten Carbide Inserts

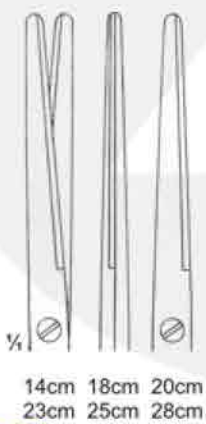
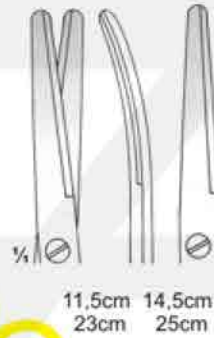
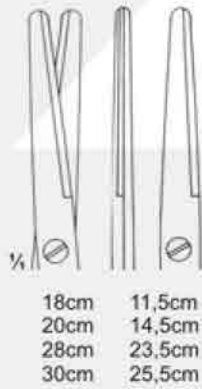

## Scissors with Tungsten Carbide Inserts

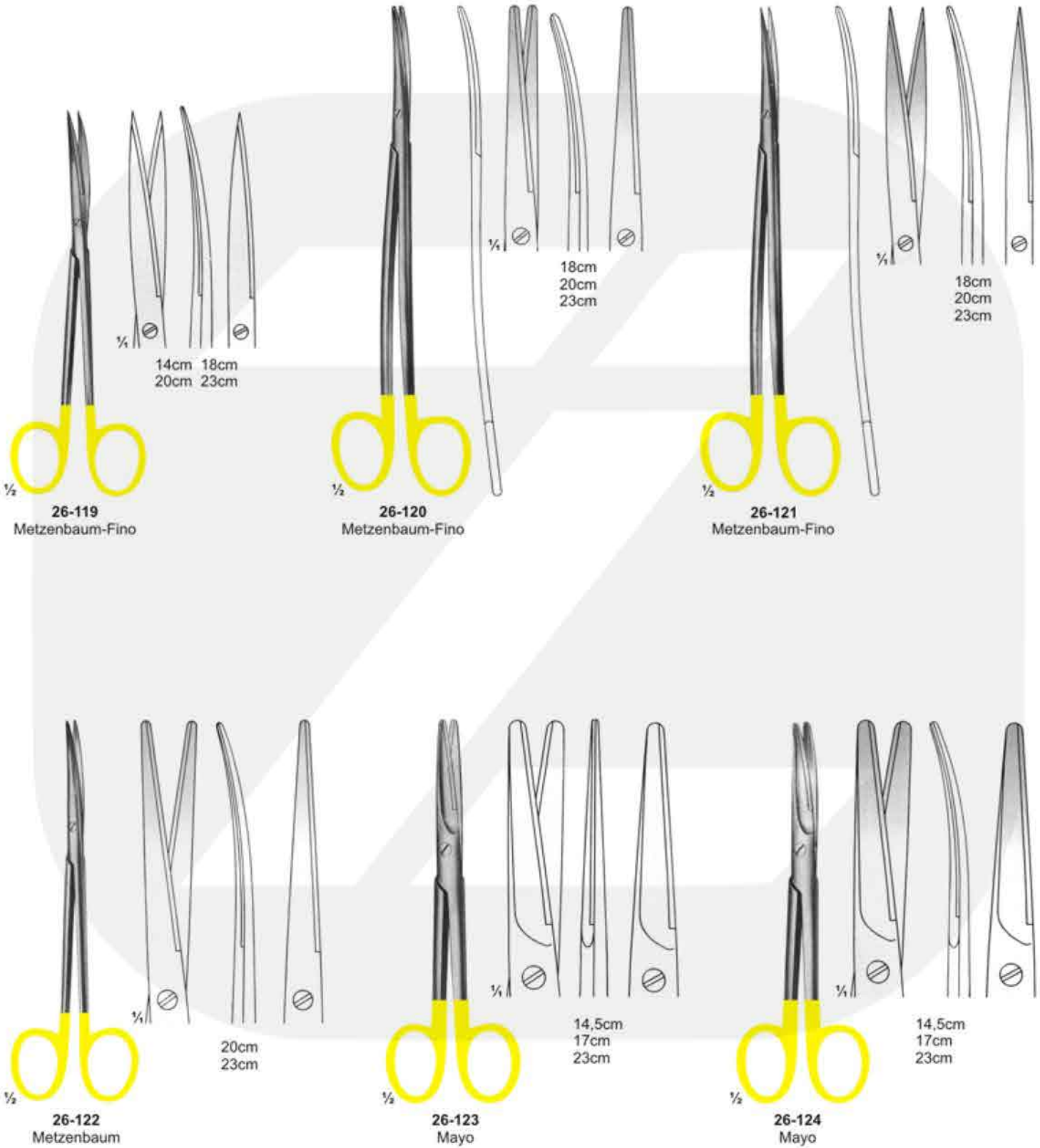

## Scissors with Tungsten Carbide Inserts





## Scissors with Tungsten Carbide Inserts

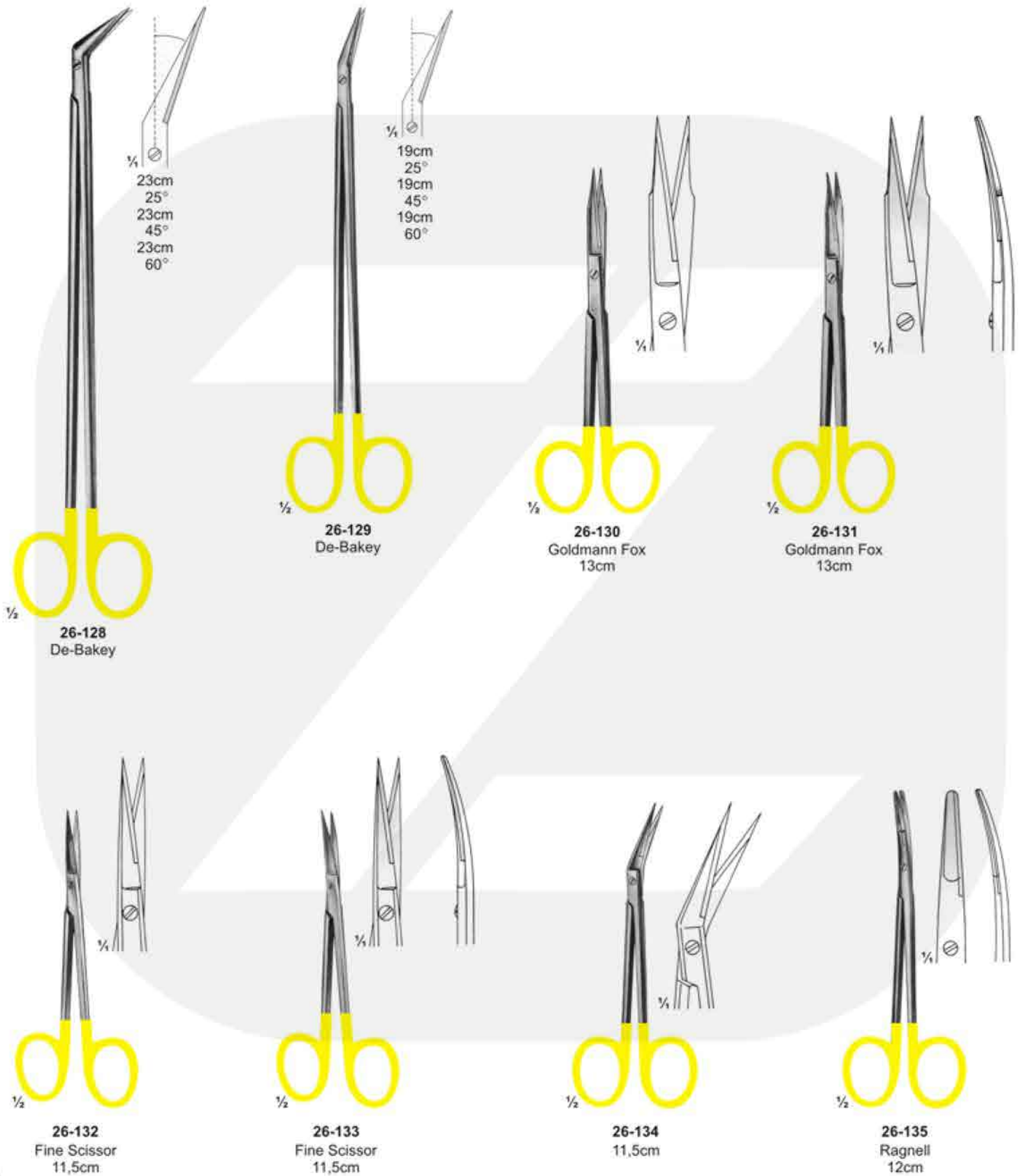



## Scissors & Dissecting Forceps with Tungsten Carbide Inserts

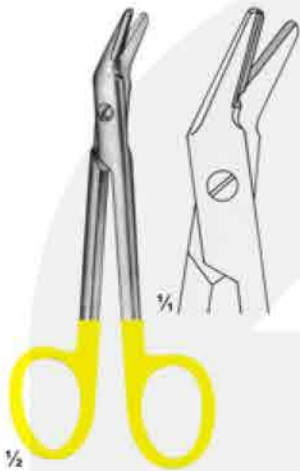

**26-136**  
Universal  
12cm



**26-137**  
Ligature Scissors  
1 Black & 1 Goldplated ring



**26-138**  
Adson



**26-139**  
Cushing  
17,5cm



**26-140**  
Cushing  
18cm



**26-141**  
Cushing-Taylor  
18cm



**26-142**  
Dissecting Forceps  
15cm



**26-143**  
Semken  
15cm

## Dissecting Forceps and Needle holders with

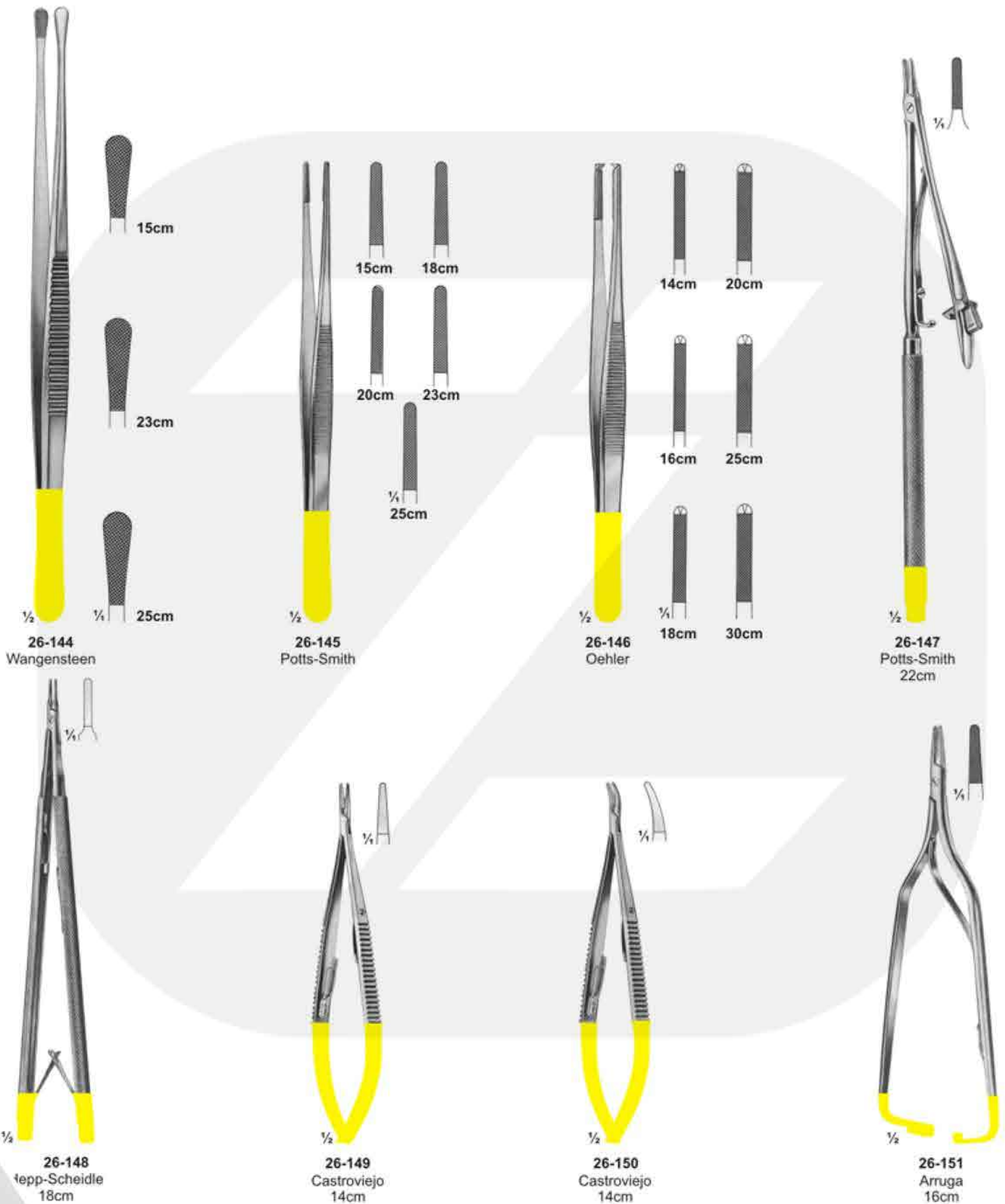

## Needle holders with Tungsten Carbide Inserts



**26-152**  
Arruga  
16cm



**26-153**  
Castroviejo  
13cm



**26-154**  
Hegar  
20cm 24cm

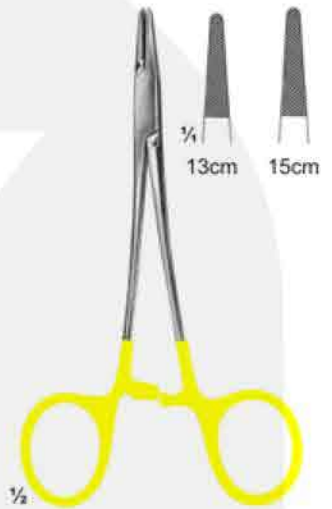

**26-155**  
Halsey  
13cm 15cm



**26-156**  
Mayo-Hegar  
16cm 18cm 20cm  
24cm 26cm 30cm



**26-157**  
De-Bakey  
18cm 20cm 23cm  
26cm 31cm 37cm

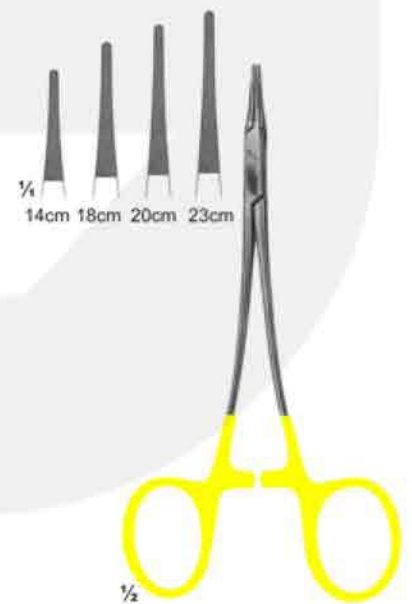

**26-158**  
Hegar-Vascular  
14cm 18cm  
20cm 23cm

## Needle holders with Tungsten Carbide Inserts



$\frac{1}{2}$   
**26-159**  
Bozemann-Wertheim  
20cm 24cm 26cm



$\frac{1}{2}$   
**26-160**  
Stratte  
22cm 23cm



$\frac{1}{2}$   
**26-161**  
Ryder  
13cm 15cm 18cm  
20cm 23cm 26cm

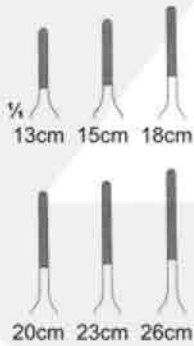

$\frac{1}{2}$   
**26-162**  
Ryder-Vascular  
13cm 15cm 18cm  
20cm 23cm 26cm

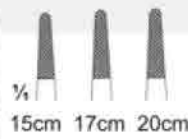

$\frac{1}{2}$   
**26-163**  
Martin  
15cm 17cm 20cm

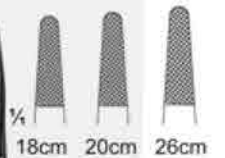

$\frac{1}{2}$   
**26-164**  
Sarot  
18cm 20cm 26cm



## Needle holders with Tungsten Carbide Inserts

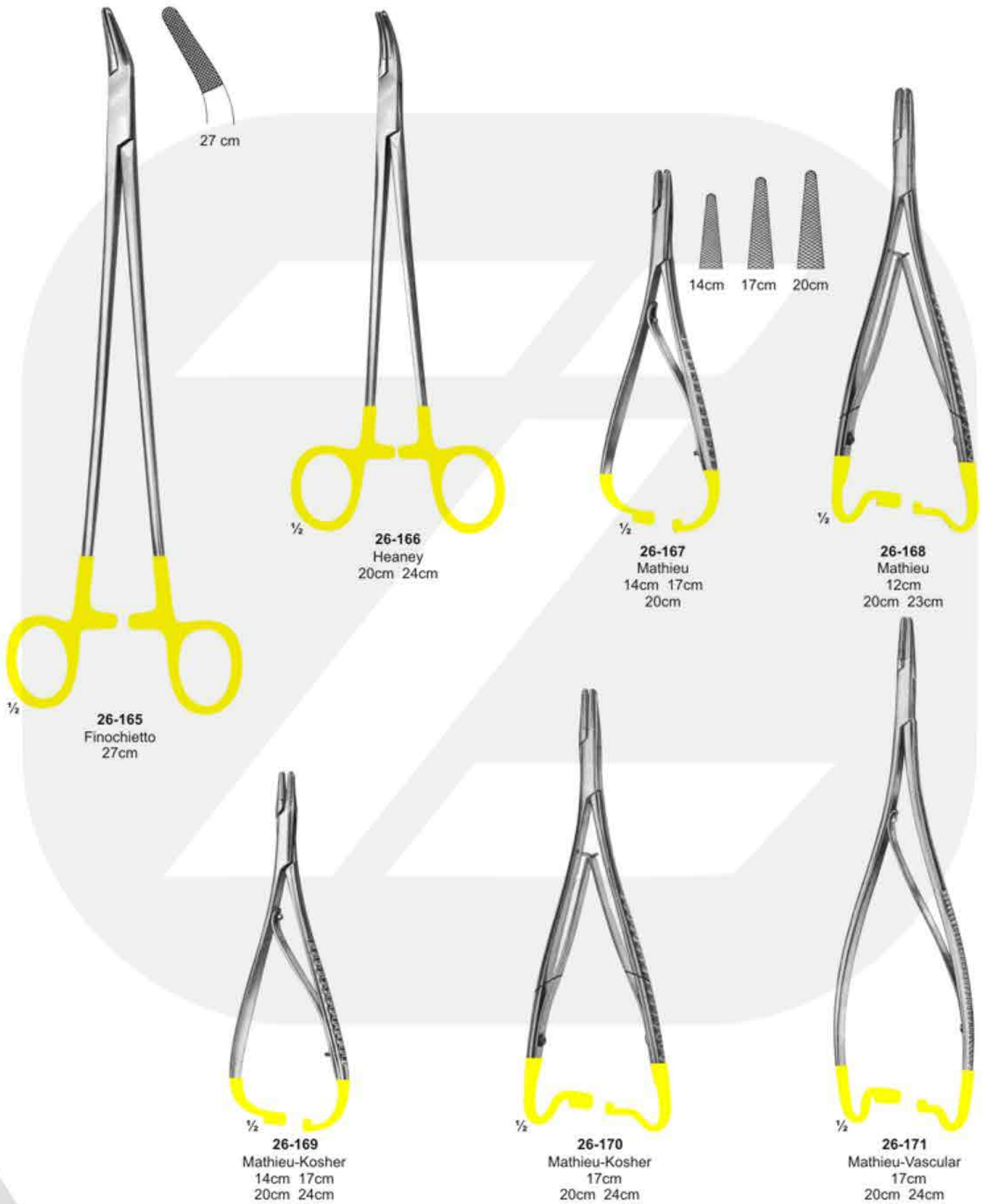

## Needle holders with Tungsten Carbide Inserts



26-172  
Mathieu-Ryder  
17cm  
20cm 24cm



26-173  
Lichtenberg  
20cm



26-174  
Langhals  
20cm 25cm



26-175  
Lichtenberg  
20cm 25cm



26-176  
Luehty-Beck  
20cm 25cm



26-177  
Luehty-Beck  
20cm 25cm



26-178  
Langebeck  
18cm  
20cm 23cm

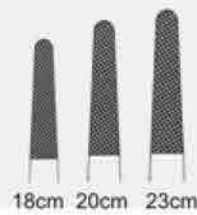

26-179  
Langebeck-beck  
18cm  
20cm 23cm

## Wire Cutting Plier With T.C. Inserts



**26-180**  
**TOENNIS**  
Elastic pattern for  
dura-or intestinal suture  
180 mm



**26-181**  
**Cutting Plier**  
12 cm



**26-182**  
**MULLAR CLAUS**  
22 cm



**26-183**  
**Plier**  
17.5 cm



# Alphabetical Index

<b>A</b>	
ABRAHAM, tonsil knife	13
ADSON, forceps	33
ADSON, forceps	37
ALLIS, artery traction forceps	47
ALLIS, intestinal grasping forceps	86
ALY, aesthesiometer	01
AMPUTATING KNIVES	12
ANDREW, tongue depressor	04
ANESTOPHON, stethoscope	02
ARRUGA, forceps	37
ARRUGA, needle holder	61
ASCH, biopsy curettes	112
AUFRIEHT, rasps	138
AYRE, cone knife, 235mm	13
ADSON - BROWN, Tissue Forceps	39
ADSON, Haemostatic Forceps	52
ANGLE, Wire Cutters Cutting Scissors	151
<b>B</b>	
BABCOCK, intestinal grasping forceps	86
BABY-ALLIS, artery traction forceps	47
BACKHAUS, towel clamps	48
BACKHAUS-KOCHER, towel clamps	48
BAILEY, rib spreaders	128
BAKES, gall duct dilators	95
BALFOUR, abdominal retractors	85
BALFOUR-BABY, abdominal retractors	84
BANE-HARTMANN, bone rongeurs	144
BARTH, bone curettes	139
BABY-MOSQUITO, Haemostatic Forceps	51
BABY-ROUX, Retractors	73
BABY-SENN-MILLER, Retractors	73
BEEBE wire scissor	29
BEER, cilia forceps	42
BENGOLEA, delicate forceps	50
BERGER, biopsy forceps	115
BERLINER, percussion hammer	01
BENDING PLIERS, Wire Holding forceps	150
BERTILLON, Examination & Measuring Instruments	10
BIEMER, vein scissor	16
BISHOP-HARMON, forceps	37
BIEMER, Suction Instruments	158
BLAKE, gall stone forceps	96
BLUMENTHAL, bone rongeurs	144
BONNEY, tissue forceps	41
BOSE, tracheal hooks	119
BOWLES, stethoscope	02
BOYS-ALLIS, artery traction forceps	47
BOZEMANN, dressing forceps	108
BOYNTON, Needle Holders	47
BRAUN, artery traction forceps	107
BRAUN, uterine probes	28
BRAUN-STADLER episiotomy scissor	31
BRAUN-STADLER, bandage scissors	102
BRIESKY, vaginal specula	66
BRODIE, probes	34
BROPHY, dissecting forceps	04
BRUENINGS, tongue depressor	13
BRUNINGS, tonsil knife, 215mm	76
BRUNNER, retractors	126
BRUNNER, rib shears	31
BRUNS, plaster scissor	64
BRYANT, sponge forceps	43
BROPHY, Tissue Forceps	38
BROWN, Tissue Forceps	39
BUCHS, retractors	75
BUCHWALD, tongue depressor	04
BUCK, neurological hammer	01
BUMM, ovum forceps	230
BUCK, Ear Curettes	110
<b>C</b>	
CASPAR, retractor	75
CASPAR, Micro scissor 115mm	16
CASTROVIEJO, tissue forceps	37
CASTROVIEJO, micro spring scissor	15
CASTROVIEJO, needle holder	61
CASTROVIEJO, eye scissor 110mm	15
CASTROVIEJO, eye scissor 115mm	15
CATLIN, amputating knife 160mm	12
CALIPER, Examination & Measuring Instruments	10
CARREL, Haemostatic Forceps	51
CARROLL, Examination & Measuring Instruments	10
CASPAR, Rongeurs	133
CASPAR, Rongeurs	134
CASTROVIEJO, Examination & Measuring Instruments	10
CHAPUT, artery traction forceps	47
CLOWARD, lamina Spreaders	83
CLAUS PLIER, Wire Cutting Plier With T.C. Inserts	187
CLAUS PLIER, Wire Cutting Plier With T.C. Inserts	187
COAKLEY, antrum trocars	100
COLLIN, intestinal grasping forceps	86
COLLIN, rib shears	126
COLLIN, sponge and dressing forceps	44
COLLIN, tongue forceps	05
COLLIN, vaginal spatula	101
CONE KNIFE 235mm11	13
CONVERSE, fine wound retractor	69
COOLEY, multi purpose clamps	122
COTTLE, retractors	71
COTTLE, nasal scissor	25
COTTLE, fine wound retractor	69
COTTLE, mallets	140
COLLIN, Examination & Measuring Instruments	10
COLLIN, Intestinal Grasping Forceps	46
COLLIN, Retractors	73
COLLIN-HARTMANN, Retractors	73
COTTLE, Forceps, Bayonet - Shaped	40
COTTLE, Nasal Specula	91
CRILE, Haemostatic Forceps	52
CRILE, Haemostatic Forceps	52
CRILE, Retractors	73
CUTTING PLIER, Wire Cutting Plier With T.C. Inserts	187
CRAFOORD, haemostatic forceps	50
CRILE, needle holder	63
CUSCO, vaginal specula	101
CUSHING, wound and vein retractor	71
CUSHING, dissecting forceps	34
CUSHING-KOCHER, retractors	71
CZERNY, gall stone forceps	96
CZERNY, retractors	72



# Alphabetical Index

<b>D</b>		<b>F</b>	
DAVIDSON, scapula retractors	77	FARABEUF, Retractors	73
DAVIS, vascular spatulas	120	FEILCHENELD, splinter forceps	42
DANDY, Haemostatic Forceps	51	FERGUSSON, haemorrhoidal forceps	93
DE BAKEY, forceps	36	FERGUSSON, suction instrument	163
DE BAKEY, anastomosis clamps	89	FERGUSSON-ACKLAND, mouth gag	05
DE BAKEY, anastomosis clamps	125	FINOCHIETTO, forceps	58
DE BAKEY, arteriotomy scissor	22	FINOCHIETTO, rib spreader	127
DE BAKEY, vana cava clamps	123	FINSEN, tracheal hooks	119
DE BAKEY, multi purpose clamps	122	FIBER OPTIC, laryngoscopes	09
DE BAKEY, retractors	82	FINGER NAIL DRIL, Finger Nail Instruments	155
DE BAKEY, atraumata	121	FINGER RING SAW, Finger Nail Instruments	155
DEAN, nasal and tonsil scissor	25	FINSTERER, Suction Instruments	161
DEAVER, retractors	77	FLAT-NOSED PLIERS, Wire Holding forceps	150
DEAVER, surgical scissor (flat lock)	21	FOERSTER-BALLENGER, Tissue Grasping Forceps	45
DE-BAKEY, bulldog clamps	49	FORCEPS, Finger Nail Instruments	155
DEJERINE, percussion hammer	01	FOREGGER, laryngoscopes	09
DELICATE DISSECTING FORCEPS	33	FOMON, nasal scissor	19
DELICATE SCISSORS, blunt points	19	FORD-BOWLES, stethoscope	02
DELICATE SCISSORS, sharp points	18	FOWLER, tonsil knife	13
DELICATE SCISSORS, sharp points	19	FRANCKE, blood lancet	06
DENHARDT, mouth gag	05	FRAZIER, fine wound retractor	69
DENIS-BROWENE, intestinal forceps	41	FRAZIER, suction instruments	163
DERRA, multi purpose clamps	122	FREER, fine wound retractor	69
DESCHAMPS, ligature needles	65	FREER, vascular spatulas	120
DESJARDINS, gall duct forceps	95	FRENZEL, tongue depressor	04
DESJARDINS, gall stone forceps	96	FRICKE, haemostatic forceps	56
DESJARDINS, gall stone scoops	95	FRITSCH, retractor	79
DESMARRES, wound and vein retractors	71		
DEMEL, Cerclage Instruments	148	<b>G</b>	
DIAGNOSTIC SETS	07	GALLAHER, rasp	126
DICK, vaginal clamps and compression forceps	59	GELPI, special retractors	82
DIEFFEBACH, bulldog clamps	49	GELPI, vaginal retractors	105
DINGMANN, bone holding forceps	142	GERALD, dissecting forceps	34
DISSECTING KNIVES	11	GIERTZ-STILLE, rib shears	126
Dissection Instruments	164	GILL, tissue forceps	37
Dissection Instruments	165	GILL-HESS, tissue forceps	37
Dissection Instruments	166	GILLIES, fine wound retractor	69
DITTEL, metal bougies	80	GILLIES, needle holder	63
DOYEN, abdominal retractors	79	GLOVER, bulldog clamp	49
DOYEN, intestinal clamps	87	GLUCK, rib shears	126
DOYEN, ovum forceps	230	GOOD, tonsil scissors	25
DOYEN, probes	66	GORNEY, suction instruments	163
DOYEN, towel clamps	48	GOSSET, abdominal retractors	84
DOYEN, vaginal specula	104	GRAEFE, fine wound retractor	69
DUROGRIP, Wire Holding forceps	149	GRAVE, vaginal specula	102
DUROTIP, Cutting Pliers	152	GROSS, dressing forceps	43
DUROTIP, Cutting Pliers	153	GUEDEL-NEGUS, laryngoscope	08
DUROTIP, Wire Cutters Cutting Scissors	151	GUTHRIE, fine wound retractor	69
DUVAL-COLLIN, Intestinal Grasping Forceps	46	GUYON, kidney clamps	97
DUPLAY, sponge and dressing forceps	43	GERALD, Tissue Forceps	38
DUVAL, intestinal forceps	41	GILLIES, Tissue Forceps	38
		GOLDSMITH, Nasal Specula	91
<b>E</b>		GRAEFE, Tissue Forceps	39
EISELSBERD, needle holder	63	GRAEFE, Tissue Forceps	39
ELSCHING, forceps	37	GRUENWALD, Forceps, Bayonet – Shaped	40
ENGL.MOD, towel clamps	48		
EPPENDORF, biopsy forceps	115	<b>H</b>	
ESMARCH, cloth and plaster scissors	31	HALLE, vascular spatulas	120
EISELSBERG-MATHIEU, Needle Holders	64	HALSTED-MOSQUITO, haemostatic forceps	50
EXTRACTION PLIERS, Wire Holding forceps	150	HARTMANN, intestinal clamps	87

# Alphabetical Index

HARVEY, plate scissors	29	KELLY, tissue grasping forceps	44
HAJEK-KOFLER, Punches	130	KERN-LANE, bone holding forceps	143
HALSTED, Haemostatic Forceps	52	KERRISON-JACOBY, punches	129
HALSTED-MOSQUITO, Haemostatic Forceps	51	KERSTING, anastomosis forceps	89
HARTMANN, Ear Polypus Forceps	112	KELLY, Haemostatic Forceps	51
HARTMANN-HALLE, Nasal Specula	91	KERRISON, Punches	130
HARTMANN-HERZFELR, Ear Polypus Forceps	112	KILLIAN, bone shear	26
HARTMANN-HOFFMAR, Ear Polypus Forceps	112	KILLIAN, rectal spatula	90
HARTMANN-WULLSTEIN, Ear Polypus Forceps	112	KILNER, fine dissecting scissors	22
HARVEY, Wire Cutters Cutting Scissors	151	KILNER, fine wound retractor	69
HEANEY, needle holder	62	KILNER, dissecting scissor	22
HEGAR, needle holder	62	KILLIAN, Nasal Specula	90
HEGAR-OLSEN, needle holder	63	KIRSCHNER, Cutting Pliers	154
HEGER, uterine dilators	106	KIRSCHNER, Wire Extension	147
HEISS, haemostatic forceps	50	KOCHER, Haemostatic Forceps	52
HEISS, dressing forceps	58	KOCHER, Haemostatic Forceps	54
HEISTER, mouth gag	05	KOCHER-OCHSNER, Haemostatic Forceps	55
HENING, plaster spreader	157	KLIMA ROSEGGGER, trocars	100
HERGET, biopsy forceps	113	KOCHER, retractor	71
HERTZLER, abdominal retractors	84	KOCHER, bladder retractors	99
HERTZLER, rib spreaders	127	KOCHER, bone retractor	74
HESS, tissue forceps	37	KOCHER, retractors	75
HEYMANN-KNIGHT, scissors	25	KOLLE, blood lancet	06
HEYWOOD-SMITH, ovum forceps	109	KONIG, elevators	135
HEYWOOD-SMITH, sponge holding forceps	44	KONIG, raspatories	137
HEYWOOD-SMITH, tongue forceps	05	KONISATION SMESSER, retractors	57
HOLLOW NEEDLE, Suction Instruments	159	KRAUSE, biopsy tip	115
HOUSE, Suction Instruments	161	KRISTELLER, vaginal specula	102
HUBER, biopsy forceps	115	KRISTELLER, vaginal specula	103
HUNT, tumor & vessel forceps	32	KRONECKER, suture instruments	65
HUNTER, splinter forceps	42	KRONLEIN, haemostatic forceps	56
		KUMMEL, intestinal spatula	80
<b>I</b>		<b>L</b>	
INGE, lamina spreaders	83	LABORDE, tracheal dilators	119
INTEROSSEOUS, cartilage knife	12	LAHEY, artery traction forceps	47
IVES-FANSLER, anoscopies	92	LAHEY, gall duct forceps	94
<b>J</b>		LANE TRETOWAN, bone levers	136
JACKSON BURROWS, retractors	82	LANE, bone holding forceps	143
JACOBSON, bone curettes	139	LANE, bone levers	136
JACOBSON, needle holder	61	LANE, tissue forceps	41
JAEGAR, fine wound retractor	69	LANE, towel clamps	48
JAMESON, dissecting scissor	22	LANGE-HOHMANN, bone levers	136
JAMESON, needle holder	62	LANGENBACK, bone levers	135
JANSEN, bone curettes	139	LANGENBECK, with triangle handle	70
JANSEN, bone rongeurs	144	LANGENBECK, flap knife	12
JOHNS-HOPKING, bulldog clamps	49	LARYNGEAL MIRRORS	06
JOLL (FRIEDMAN), retractors	82	LAWRENCE, ligature forceps	58
JOLL, vaginal retractors	105	LANDOLT, Suction Instruments	160
JONES, towel clamps	48	LANDOLT, Suction Instruments	161
JOSEPH, bone file	138	LANGENBECK, Ear Curettes	110
JOSEPH, dura and skin retractor	69	LEBSCHKE, rib shears	126
JOSEPH, raspatories	137	LEGUEU, bladder retractors	99
JUDD-MASSON, bladder retractors	99	LEKSELL-STILLE, bone rongeurs	145
JANSEN, FORCEPS, Bayonet – Shaped	40	LERICHE, intestinal spatula	80
<b>K</b>		LEWIS, bone file	138
KADER, intestinal spatula	80	LISTER, bandage scissor	30
KALT, needle holder	61	LISTER, cloth scissor	30
KELLY, ovum forceps	109	LISTER, sponge forceps	43
KELLY, anoscopies	92	LISTON, bone cutting forceps	146



# Alphabetical Index

LOCKHART-MUMMERY, probes	66	MULLER, dura and skin retractor	69
LOCKWOOD, Intestinal Grasping Forceps	46	MURPHY, head band	03
LUCAE, FORCEPS, Bayonet – Shaped	40	MUSEUX, tissue grasping forceps	47
LUER, Retractors	73	<b>N</b>	
LOCKLIN, delicate scissor	25	NASAL SCISSORS	25
LOPEZ-REINKE, suction instruments	163	NAUJOKS wire scissors	29
LOWER, gall duct forceps	94	NAIL SPLITTING, Finger Nail Instruments	155
LOWMAN, bone clamps	143	NEEDLE HOLDER, for micro surgery	48
LOWMAN-GERSTER, bone clamps	143	NEGUS, tonsil forceps	57
LOWMAN-HOGLUND, bone clamps	143	NELATON, probes	66
LUCAS, gouges	141	NELSON, lung dissecting forceps	41
LUER-KORTE, gall stone scoops	80	NISSEN, gall duct forceps	94
LURE, bone rongeurs	144	NOTO, ovum forceps	109
<b>M</b>		NOTO, sponge holding forceps	44
MAGILL, laryngoscope	07	NOVAK-SCHOECKAERT, biopsy curettes	111
MALTZ, rasps	138	NOYES, micro spring scissor	15
MANNERFELT, osteotomes	141	<b>O</b>	
MANNERFELT, retractors	70	OLIVECRONA, dura scissors	24
MARTIN, uterine probes	107	OLIVECRONA, trigeminal knife	13
MARTINI, bone curettes	139	OTOSCOPE SETS	07
MASING, retractors	71	OTOSCOPE, Diagnostic Sets	07
MASSON, needle holder	62	<b>P</b>	
MASSON-LUETHY, needle holder	62	PARTSCH, raspatories	137
MATHIEU, retractors	72	PARTSCH, gouges	141
MAYO, dissecting scissors	23	PARTSCH, raspatories	137
MAYO, uterine probes	107	PAYR, pylorus clamps	86
MAYO-HARRINGTON, dissecting scissors	23	PEAN, haemostatic forceps	57
MAYO-NOBLE, dissecting scissors	23	PEAN, haemostatic forceps	51
MAYO-STILLE, dissecting scissors	23	PEAN, kidney clamps	97
MARTIN, Nasal Specula	90	PEDERSON, vaginal specula	102
MATHIEU, Needle Holders	64	PEET, splinter forceps	42
MATHIEU-STILLE, Needle Holders	64	PELKMANN, uterine dressing forceps	108
MC INDOE, forceps	34	PERKINS, self retaining retractors	81
MC KENTY, raspatories	137	PIERCE, trocars	100
MEAD, mallets	140	PINARD, wooden stethoscope	02
MC INDOE, Tissue Forceps	38	PLESTER, retractors	81
MCINTOSH, laryngoscopes	09	PLESTER, suction instruments	163
MEDIUM, Dissecting Forceps	35	POOL, suction instruments	162
MICRO-HALSTED, Haemostatic Forceps	51	POTTS-SMITH, cardiovascular scissor	24
MILLIN, Needle Holders	64	PROBES	67
MICHEL, laryngeal mirrors	06	PARKER, Retractors	73
MICRO SCISSORS, laterally angled	17	PEAN, Haemostatic Forceps	52
MICRO-ADSON, forceps	33	PEAN, Haemostatic Forceps	53
MICRO-ADSON, forceps	37	PEAN, Haemostatic Forceps	54
MIDDELDORPF, retractors	75	PENNINGTON, Tissue Grasping Forceps	45
MIKULICZ, tissue forceps	57	PROVIDENCE-HOSPITAL, Haemostatic Forceps	51
MIKULICZ, intestinal spatula	80	<b>Q</b>	
MIKULICZ, retractors	78	QUERVAIN, bone levers	113
MILLER, laryngoscope	08	<b>R</b>	
MILLIN, bladder retractors	99	RABINER, neurological hammer	01
MIXTER, ligature forceps	58	RANDALL, biopsy curettes	111
MOD.USA, plaster spreader	127	RANDALL, kidney stone forceps	98
MORRIS, anastomosis clamps	89	RECAMIER, uterine scoops	116
MOYNIHAN, haemostatic forceps	57	REYNOLDS, dissecting scissors	22
MOYO-HEGAR, needle holder	62	RICHTER, vaginal retractors	105
MOD. WIEN, Nasal Specula	91	ROCHESTER-CARMALT, haemostatic forceps	57
MOLTGEN, Examination & Measuring Instruments	10	ROEDER, towel clamps	48
MULLAR, Wire Cutting Plier With T.C. Inserts	187		
MULLER LIGATURE FORCEPS	49		
MULLER VESSEL CLIPS	49		

# Alphabetical Index

ROUX, retractors	72
RUDD, haemorrhoidal ligator	93
RUMEL, dissecting forceps	58
RUSS-MODELL, tissue forceps	41
ROHRSCHNEIDER, needle holder	61
ROLLET, dura and skin retractor	69
ROSER KONIG, mouth gag	05
RAMPLEY, Tissue Grasping Forceps	45
RANKIN, Haemostatic Forceps	52
REILL, Cutting Pliers	152
REPLACEMENT LAMP, laryngoscopes	09
ROCHESTER-OCHSNER, Haemostatic Forceps	54
ROCHESTER-PEAN, Haemostatic Forceps	53
ROSE, Retractors	73
ROUND PLIERS, Wire Holding forceps	150

## S

SAENGER, ovum forceps	118
SAMII, tumor grasping forceps	32
SATINSKY, vena cava scissors	24
SAUPE, cilia forceps	42
SCALPEL HANDLES	14
SCHAAF, cilia forceps	42
SCHAEDEL, towel clamps	48
SCH EINMANN, biopsy forceps	115
SCHIMMELBUSCH, ether mask	05
SCHMID, vascular spatulas	120
SCHOEMAKER-LOTH, needle holder	63
SCHOENBORN, retractors	71
SCHRODER, uterine scoops	116
SCHUMACHER, rib shears	126
SCHUMACHER, umbilical scissors	28
SCHUMASHER, biopsy forceps	114
SCOVILLE-RICHTER, retractors	67
SEGOND, myomatome	13
SEIDL, vaginal specula	102
SEIDL-DBP, biopsy forceps	114
SELLORS, rib spreaders	128
SEMKEN, dissecting forceps	34
SEMKEN, tissue forceps	37
SENN-MILLER, Retractors	73
SEUTIN, plaster scissor	31
SHAPLEIGH, Ear Curettes	110
SIMON, uterine scoops	116
SIMPLEX, tongue depressor	04
SIMPSON, uterine probes	107
SIMPSON-BRAUN, obstetrics forceps	117
SIMS, gynaecology scissors	27
SIMS, vaginal specula	102
SIMS, rectal specula	90
SIMS, uterine probes	107
SMOOTH JAWS FORCEPS	34
ST.MARTIN, tissue forceps	37
STEMBERG, tongue depressor	04
STIEGLITZ, splinter forceps	42
STILLE, bone rongeurs	145
STILLE-AESCLAP, plaster shears	156
STILLE-RUSKIN, bone rongeurs	145
STRACK, wire scissor	29
STRASSBURGER Tissue forceps	41
STANDARD, Dissecting Forceps	35
STANDARD, Tissue Forceps	39

STERBERG, Retractors	
STRULLY, cardiovascular scissors (pointed)	24
SUCTION INSTRUMENTS	162
SURGICAL SCISSORS, incision	21
SURGICAL SCISSORS, serrated	20
SURGICAL SCISSORS, slender type	20
SURGICAL SCISSORS, standard	20
SURGICAL SCISSORS, standard	20
SUTURING INSTRUMENT SET	68
SYSTRUNK, nail splitting scissors	21
SPENCER-WELLS, Haemostatic Forceps	
SYSTRUNK, Finger Nail Instruments	

## T

TAKAHASHI, rongeur	112
TAYLOR, percussion hammer	01
TAKAHASHI, Rongeurs	132
THOREK, cardiovascular scissors	24
THORPE, corneal forceps	33
TIECK-HALLE, Nasal Specula	90
TOENNIS, Wire Cutting Plier With T.C. Inserts	187
TOWNLEY, Examination & Measuring Instruments	10
TOBOLD, tongue depressors	04
TOENNIS ADSON, dissecting scissors	22
TOENNIS, dissecting scissors	22
TOENNIS, fine wound retractor	69
TOENNIS, vascular spatulas	120
TOENNIS, needle holder	63
TRELAT, raspatories	137
TRIGEMINAL KNIFE	13
TROCARS	100
TROEMNER, percussion hammer	01
TROUSSEAU, tracheal dilators	119
TROCAR, Suction Instruments	159
TROELTSCH, FORCEPS, Bayonet – Shaped	40
TUFFIER, rib spreaders	127
TUTTLE, lung dissecting forceps	41

## U

UMBILICAL CORD SCISSORS	28
UNIVERSAL BANDAGE SCISSORS	30
UNIVERSAL TROCARS	100
US-ARMY, retractors	72

## V

VANNAS, micro spring scissors	15
VERNIER, Examination & Measuring Instruments	10
WISE GRIP, Wire Holding forceps	150
VOLKMANN, bone curettes	139
VOLKMANN, bone retractors	74



## Alphabetical Index

### W

WANGENSTEEN, needle holder	62
WARTENMERG, pinwheel	01
WAGNER, Rongeurs	134
WAUGH, Tissue Forceps	38
WEBER, anastomosis clamps	124
WECKER, eye scissors	15
WEIL-BLAKESLEY, rongeurs	112
WEITLANER, self retaining retractors	81
WERTHEIM, gynaecology scissors	27
WERTHEIM, clamps and forceps	59
WERTHEIM-CULLEN, vaginal clamps	60
WIEDER, tongue depressor	04
WEIL-BLAKESLEY, Rongeurs	132
WILLIGER, bone curettes	139
WILLIGER, elevators	135
WILLIGER, raspatories	137
WINTER, ovum forceps	118
WILDE, Forceps, Bayonet – Shaped	40
WOLFF, plaster breakers	157
WULLSTEIN, retractors	81
WULLSTEIN, Suction Instruments	160

### Y

YASARGIL, needle holder	61
YASARGIL, tumor grasping forceps	32
YASARGIL-SAMII, tumor grasping forceps	32
YASARGIL, Suction Instruments	160
YASARGIL, Suction Instruments	161
YASRGIL, micro scissors	17
YEOMAN, biopsy forceps	113
YOUNG, tongue forceps	05
YOUNG– HRYNTSCHAK, Needle Holders	64
YOUNG-MILLIN, Needle Holders	64

### Z

ZENKER, ligature	58
ZENKER, retractors	77
ZIEGLER, head band	03
ZIEGLER, head mirror	03

## About us

Zolarex is a manufacturing company of high quality of following instruments

### **Surgical Instruments (Single use & Reusable)**

Hollow ware & Hospital Supplies,  
Orthopedic Instruments,  
Gynecology Instruments

### **Dental Instruments, Orthodontic Pliers**

Manicure & pedicure Instruments  
Cutters / Cuticle nippers / Eyebrow Tweezers / Cuticle Pushers / Black head removers / Corn cutters etc.

### **Scissors**

Professional Hair cutting scissors with razor edge,  
Professional thinning scissors,  
Pet grooming scissors,  
Tailor scissors,  
Household Scissors,  
Surgical & Dental Scissors,  
Veterinary scissors,  
cuticle scissors,  
plastic handle scissors,  
sheep scissors etc.

### **Veterinary instruments & Horse products**

We have been working in this field since 2002 and supplying our products all over the world.

We offer all kind of above mentioned products which are producing in Sialkot - Pakistan.

The additional final quality control takes place before shipment. Thus we guarantee the high quality and flawless condition of our products, a claim that you rightly expect from us.

So we can assure you that our products marked with "MUGHAL IMPEX" or your brand Name fast delivery with guaranteed Satisfaction. Our business is dedicated in providing fast and efficient services with high commitment in satisfying the customers.



## **Address:**

Near Alam Chowk Shabpura,  
Sialkot 51310 Pakistan

**Mob:** +92 316 7619193

**Email:** info@zolarexintl.com

zolarex.intl@gmail.com

**Web:** www.zolarexintl.com