



Zolarex
INTERNATIONAL

**SURGICAL
INSTRUMENTS**

www.zolarexinel.com



Wire Extension

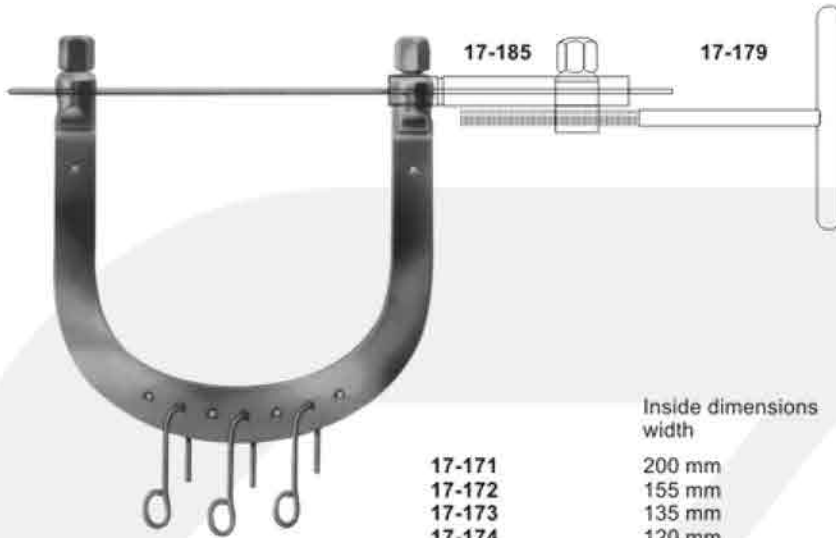

17-171 - 17-177
KIRSCHNER
 Wire traction bows,
 to be used with
 KIRSCHNER-wires
 up to 2.5 mm diam.,
 With 3 hooks,
 stainless steel

	Inside dimensions width	depth	
17-171	200 mm	155 mm	for the hip
17-172	155 mm	155 mm	for the femur
17-173	135 mm	130 mm	for the knee
17-174	120 mm	120 mm	for the knee
17-175	105 mm	100 mm	for the knee
17-176	95 mm	110 mm	for the calcaneus
17-177	95 mm	70 mm	for the arm and elbow



17-178
 Wrench, double - ended,
 for wire traction bows



17-179
 Wire tightener, with
 clamping jaws



17-182	max. 105 mm
17-183	max. 160 mm
17-184	max. 200 mm
17-182	80-95 mm
17-183	90-120 mm
17-184	140-170 mm
diam upto	
17-182	1,6 mm
17-183	2,0 mm
17-184	2,5 mm

17-182 - 17-184
KIRSCHNER
 Wire traction bows, modified,
 adjustable in width, holds wire
 securely, with 1 hook



17-180
 Traction hook only,
 large size



17-181
 Traction hook only,
 small size



17-185
 Fixation clamp, to secure clamping
 jaws of 17-179 stainless steel

Cerclage Instruments

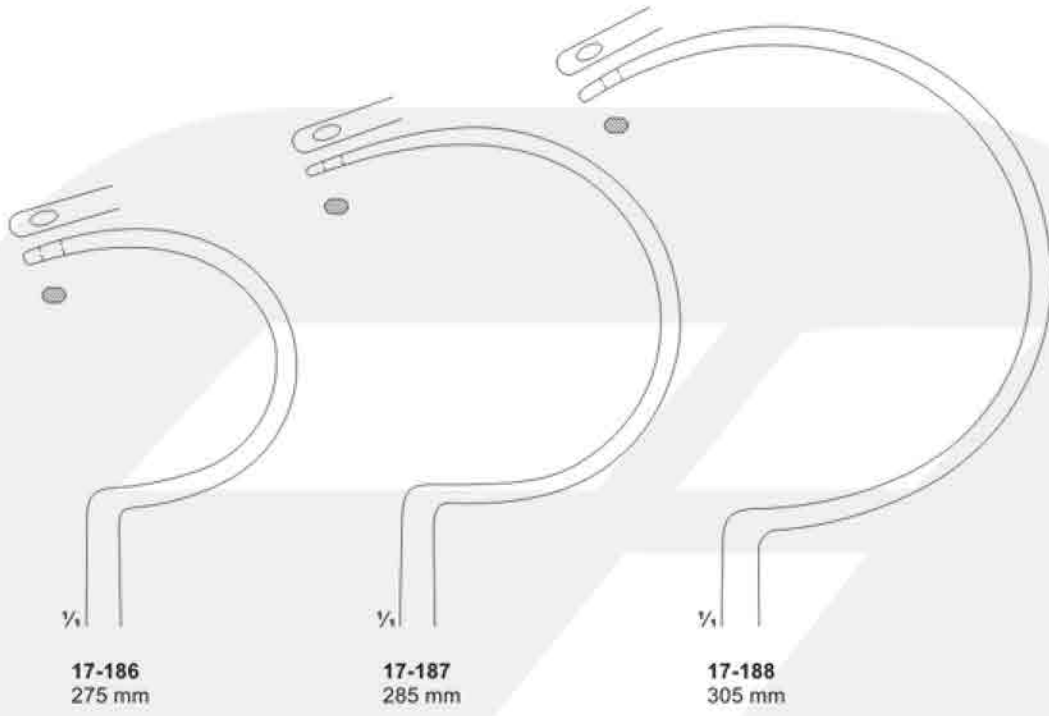

17-186
275 mm

17-187
285 mm

17-188
305 mm



17-186 - 17-188
DEMEL
Wire guides



17-189
240 mm

17-190
270 mm

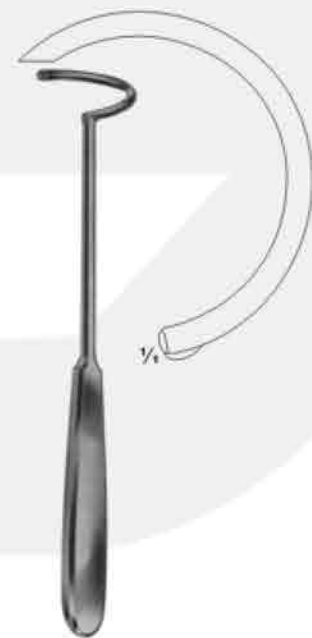

17-191
225 mm

Wire Holding forceps, Wire Tightening Pliers, Flat-nosed Pliers DUROGRIP with Hard Metal Inserts



17-192
DUROGRIP
Holding forceps for cerclage wire, with lateral jaws to avoid wire slipping off
170 mm



17-193
DUROGRIP
Wire, tightening pliers,
Ligature pliers
150 mm



17-194
DUROGRIP
Wire, tightening pliers,
Ligature pliers
150 mm



17-195
with serrated jaws
140 mm



17-196
one jaw smooth,
one jaw serrated
140 mm



17-197
with serrated jaws
17-198
with longitudinal and
transversal grooves
170 mm



17-199
190 mm

Wire Holding forceps, Flat-nosed Pliers, Pliers for bending and cutting wires



17-200
130 mm

17-201
180 mm



17-200 - 17-201
Extraction pliers
for boring wires



17-202
Flat-nosed pliers,
parallel
185 mm

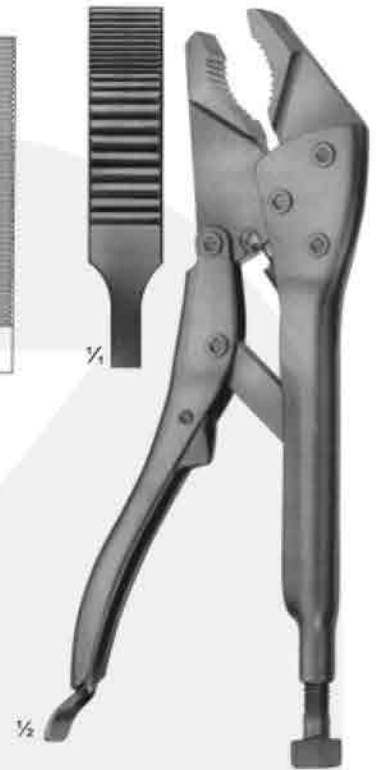

17-203
Vise grip
200 mm

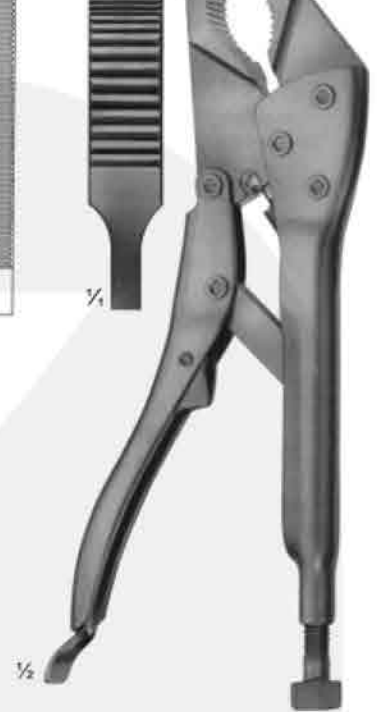

17-204
Round Pliers
180mm



17-204



17-204



17-205



17-206



17-207

17-205 145 mm
17-206 180 mm
17-207 180 mm
Extraction pliers for wires

17-204 - 17-207



17-208
Bending pliers
for wires up to
1.8 mm diam.



Wire Cutters and wire Cutting Scissors DUROTIP with Carbide Cutting Edges



17-209
ANGLE
130 mm

for soft wire
up to diam.
for hard wire
up to diam.

0,5 mm
0,3 mm



17-210
DUROTIP
ANGLE
130 mm

0,6 mm
0,4 mm

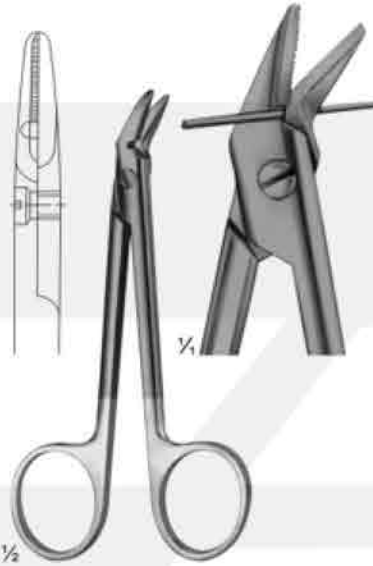

17-211
120 mm

for soft wire
up to diam.
for hard wire
up to diam.

1,2 mm
0,8 mm

17-212
DUROTIP
120 mm

1,2 mm
0,8 mm

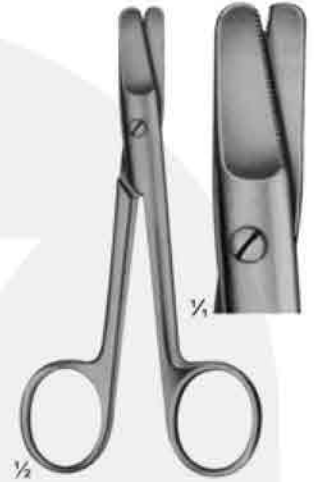

17-213
HARVEY
125 mm

0,4 mm
0,3 mm



17-214
150 mm

for soft wire
up to diam
for hard wire
up to diam

1,5 mm
1,0 mm



17-215
160 mm

1,5 mm
1,2 mm



17-216
140 mm
DUROTIP
1,5 mm

1,0 mm

Wire Cutting Pliers, Lateral Cutting Action

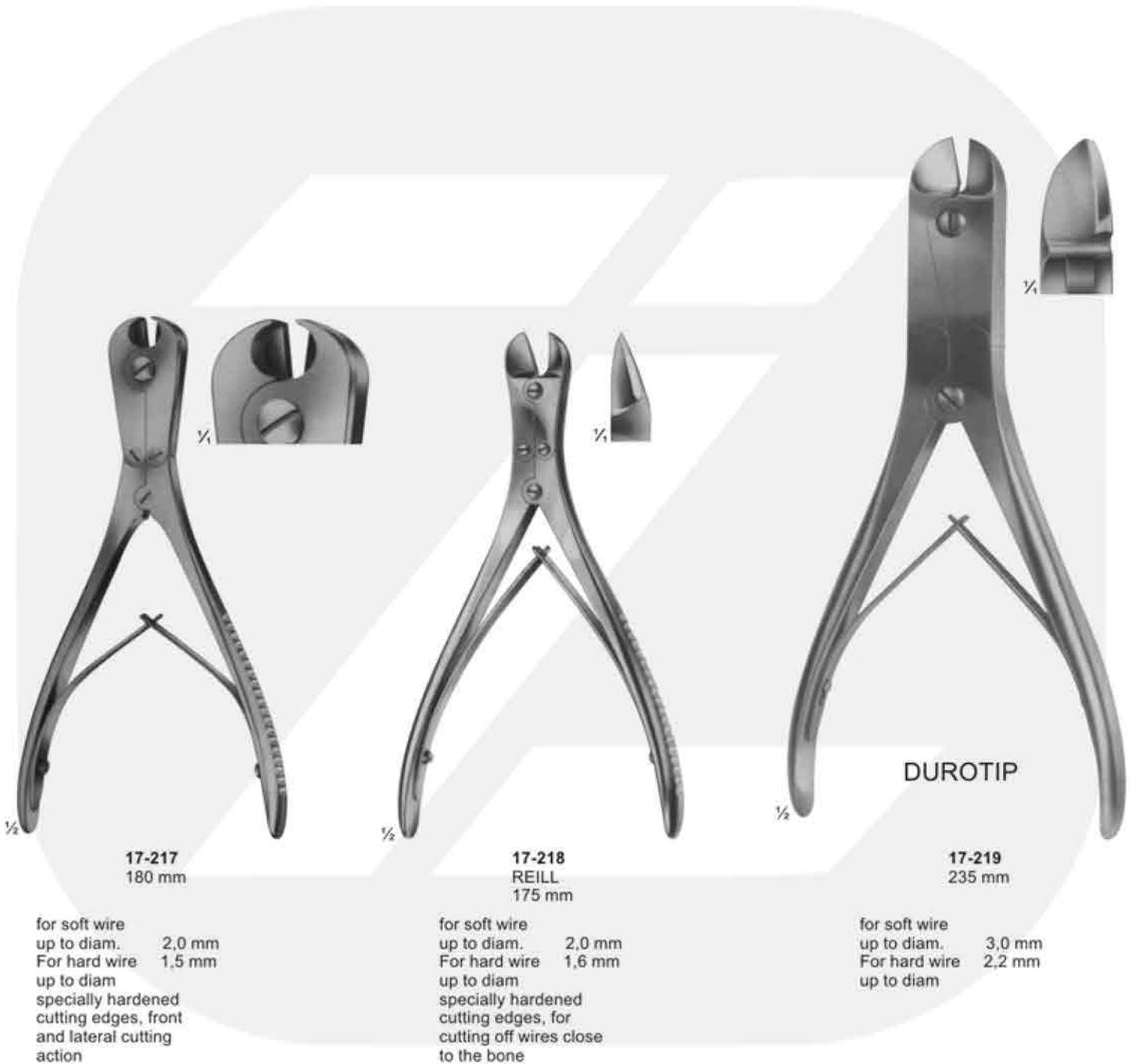

17-217
180 mm

for soft wire
up to diam. 2,0 mm
For hard wire 1,5 mm
up to diam
specially hardened
cutting edges, front
and lateral cutting
action

17-218
REILL
175 mm

for soft wire
up to diam. 2,0 mm
For hard wire 1,6 mm
up to diam
specially hardened
cutting edges, for
cutting off wires close
to the bone

DUROTIP

17-219
235 mm

for soft wire
up to diam. 3,0 mm
For hard wire 2,2 mm
up to diam

Wire Cutting Pliers, Lateral and Front Cutting Action



Wire Cutting Pliers



17-224
320 mm

for soft wire
up to diam. 3,0 mm
For hard wire
up to diam. 3,0 mm



Cutter for cutting off
KIRSCHNER wires,
Tibia head screws,
bolts, pins, up to 3 mm diam.



DURROTIP

17-225
Cutter for cutting off
KIRSCHNER wires,
Tibia head screws,
bolts, pins, up to 6 mm diam.
470 mm

Finger Nail Instruments

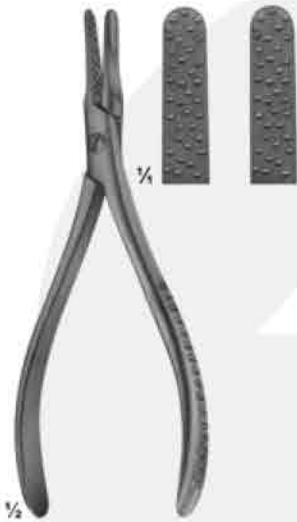

17-226
Nail extracting
forceps
135 mm



17-227
Nail extracting
forceps
145 mm

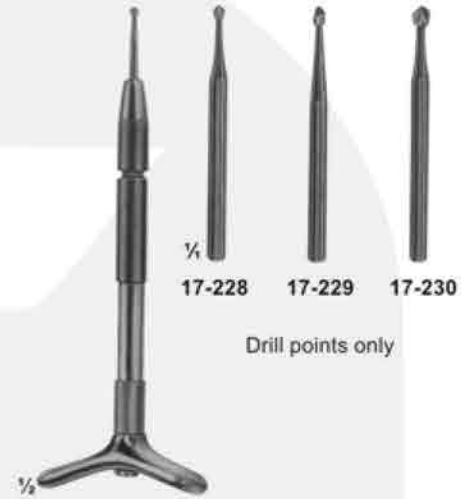

17-228
Finger nail drill
with 3 drill points

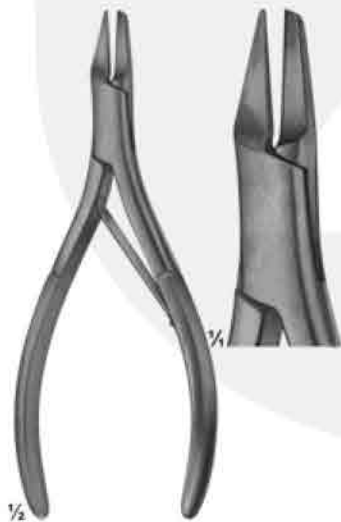

17-231
Nail splitting
forceps
135 mm



17-232
SYSTRUNK
Scissors, for splitting
finger nails
130 mm



17-233
Finger ring saw
150 mm

Plaster Shears



17-235
STILLE-AESFULAP
260 mm

17-236
STILLE-AESFULAP
360 mm

Plaster Spreader, Plaster Breakers

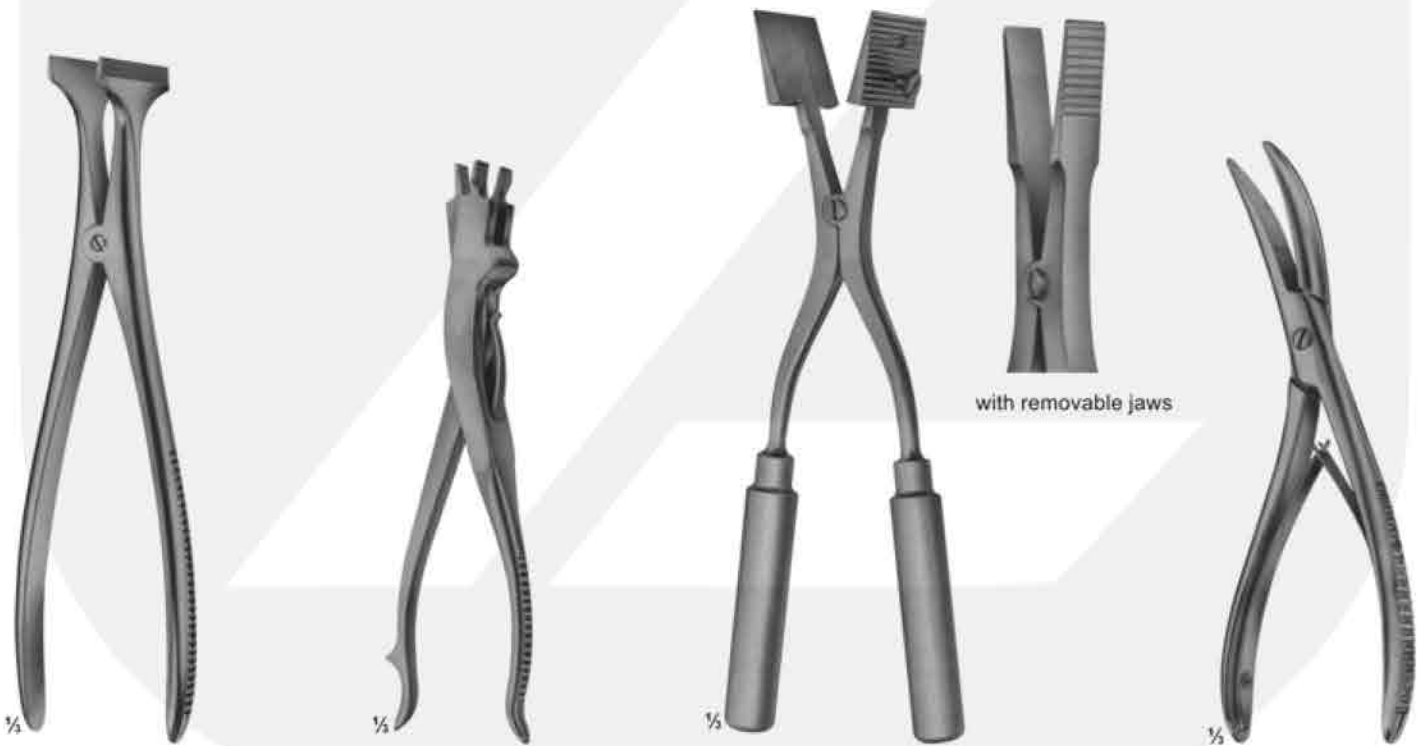

with removable jaws

17-237
HENING
270 mm

17-238
MOD.USA
230 mm

17-239
290 mm

17-240 - 17-241
WOLFF
17-240 180 mm
17-241 240 mm
plaster breakers

About us

Zolarex is a manufacturing company of high quality of following instruments

Surgical Instruments (Single use & Reusable)

Hollow ware & Hospital Supplies,
Orthopedic Instruments,
Gynecology Instruments

Dental Instruments, Orthodontic Pliers

Manicure & pedicure Instruments
Cutters / Cuticle nippers / Eyebrow Tweezers / Cuticle Pushers / Black head removers / Corn cutters etc.

Scissors

Professional Hair cutting scissors with razor edge,
Professional thinning scissors,
Pet grooming scissors,
Tailor scissors,
Household Scissors,
Surgical & Dental Scissors,
Veterinary scissors,
cuticle scissors,
plastic handle scissors,
sheep scissors etc.

Veterinary instruments & Horse products

We have been working in this field since 2002 and supplying our products all over the world.

We offer all kind of above mentioned products which are producing in Sialkot - Pakistan.

The additional final quality control takes place before shipment. Thus we guarantee the high quality and flawless condition of our products, a claim that you rightly expect from us.

So we can assure you that our products marked with "MUGHAL IMPEX" or your brand Name fast delivery with guaranteed Satisfaction. Our business is dedicated in providing fast and efficient services with high commitment in satisfying the customers.



Address:

Near Alam Chowk Shabpura,
Sialkot 51310 Pakistan

Mob: +92 316 7619193

Email: info@zolarexintl.com

zolarex.intl@gmail.com

Web: www.zolarexintl.com